



CATÁLOGO2022

# wiha

Tools that work for you







## Wiha - Nuestro objetivo: Su éxito

- **Su garantía de calidad**

Ganador del premio Manufacturing Excellence Award 2014 como mejor PYME de Alemania.

- **Fiable y auténtico**

Empresa familiar alemana con más de 80 años de experiencia.

- **Su ventaja**

Soluciones individuales de problemas para profesionales.

- **Tecnología punta**

Innovaciones premiadas, apreciadas por profesionales de todo el mundo.

¿Qué puede facilitarle su trabajo? Herramientas que aumenten su eficiencia, reduzcan sus gastos y protejan su salud. Por ello, Wiha desarrolla, construye y fabrica productos con las máximas exigencias en cuanto a funcionalidad, durabilidad y ergonomía.

Wiha fue fundada hace más de 80 años como pequeño negocio familiar para piezas normalizadas y tornillos y actualmente es una empresa con actualización internacional y con fábricas en toda Europa, Asia y los EE.UU., que sigue siendo dirigida por la familia Hahn como propietarios.

Wiha ofrece a los profesionales una amplia gama de herramientas Premium de alta calidad que se caracterizan por la utilización de las tecnologías de fabricación más modernas, las innovaciones orientadas al usuario, la superioridad ergonómica, la máxima calidad, la fiabilidad absoluta y la vida útil prolongada. En resumen: Herramientas que le facilitarán el trabajo de manera sensible - tools that work for you.

Obtenga más información sobre Wiha visitando la página Web:

[www.wiha.com](http://www.wiha.com)



# Visiones y valores de Wiha

## Wiha avanza hacia un futuro exitoso con responsabilidad e innovación.

---

¿Qué hace que una empresa tenga éxito? Por un lado, son fundamentales los buenos productos y, por otro lado, una cultura empresarial excelente. La alta calidad de las herramientas de Wiha en cuanto a diseño y funcionalidad ha sido confirmada con numerosos premios internacionales. Como empresa familiar dirigida por su dueño, mantenemos una cultura de convivencia: Desde la promoción de los empleados hasta la gestión activa de clientes, Wiha hace todo lo posible para crear unas condiciones óptimas de trabajo y comerciales y una base para un futuro sostenible.

Como miembro de la Iniciativa de cumplimiento de la Asociación alemana de gestión de materiales, compras y logística (BME), Wiha se rige según el código de conducta que obliga al cumplimiento de normas de conducta empresarial, de principios para la responsabilidad social y de la obligación de promoción frente a proveedores y, de este modo, garantiza el comportamiento legal de las empresas y los empleados.

En 2016 Wiha fue incluida en el TOP 100 de medianas empresas alemanas más innovadoras. En el concurso, que se concede en el marco de la „Cumbre de medianas empresas alemanas“, Wiha logró convencer por su cultura de innovación real. Para nosotros supone una bonita confirmación de nuestra filosofía de empresa caracterizada por el progreso y las visiones.

---

### Wiha - Nuestras visiones

- **Empresa familiar económicamente exitosa**

Wiha es dirigida por su dueño desde hace 80 años y tiene éxito en el mercado.

- **Marca Premium internacional**

Wiha suministra a un mercado internacional con fábricas en Europa, Asia y los EE.UU.

- **Equipo excelente altamente motivado:**

Los empleados de Wiha son competentes y están comprometidos y motivados gracias a las condiciones de trabajo óptimas.

- **Enfoque al usuario y a la aplicación**

Los productos de Wiha permiten al usuario realizar un trabajo eficiente y que protege su salud.

---

# Premios al diseño de Wiha

## La ergonomía tiene su precio.



La respuesta positiva de las personas para las que hacemos nuestras herramientas es para nosotros la mejor confirmación de nuestro trabajo. A pesar de ello, al mismo tiempo podemos estar más que orgullosos cuando la alta calidad ergonómica de nuestros productos es confirmada desde el "máximo" nivel. Ya que muchos de estos productos han sido premiados con premios al diseño codiciados. Además, la calidad empresarial y de producción también ha sido reconocida con premios. Elogios y confirmación desde todos los lados: Por lo tanto, no hay dudas, Wiha está en el camino correcto con los conceptos ergonómicos de herramientas y con una filosofía orientada al futuro.

### 2022



### 2021

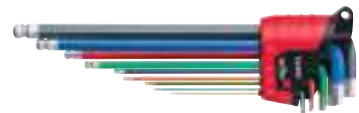

Focus Open 2021  
Silver

## 2020



Focus Open 2020  
Special Mention



## 2019



red dot award 2019  
winner



Focus Open 2019  
Silver

## 2018



Focus Open 2018  
Special Mention



# Herramientas de Wiha con el sello de calidad de AGR

## Las primeras herramientas a nivel mundial con el sello que garantizan un trabajo eficiente y que protege su salud.

---



Geprüft und empfohlen vom Forum: Gesunder Rücken - besser leben e.V. und dem Bundesverband deutscher Rückenschulen (BdR) e.V. Weitere Infos bei: AGR e.V., Stader Str. 6, 27432 Bremervörde, Tel. 04761/92 63 580, [www.agr-ev.de](http://www.agr-ev.de)



¡Ergonomía premiada!  
Como primer fabricante de herramientas manuales en todo el mundo, Wiha obtiene el sello de calidad de AGR por

sus alicates Inomic® y su concepto ergonómico de tamaños de mango para destornilladores. Esta distinción goza de una gran aceptación en la comunidad de profesionales médicos.

Ergonomía premiada: el concepto de tamaños de mango para destornilladores de Wiha y el concepto de mango de alicates Wiha Inomic®. Cuando se recibe como primer fabricante de herramientas manuales en todo el mundo la distinción para sus productos con el prestigioso sello de calidad de AGR, es una sensación única. Ya que tan solo unos pocos artículos de uso resisten las rigurosas pruebas de la asociación AGR, cuyo sello no en vano goza de una gran aceptación en la comunidad de profesionales médicos.

La AGR está comprometida desde hace años con la promoción de la investigación para la prevención de dolores de espalda y ofrece recomendaciones para prevenir enfermedades del aparato locomotor y los dolores de espalda.





---

Wiha ha sido reconocida ahora por su concepto de tamaños de mango para destornilladores y por su concepto de mango de alicates Inomic®. Esta distinción representa para nosotros la confirmación de nuestra filosofía: Desarrollar herramientas con las que el profesional no solo puede trabajar de manera eficiente, sino también protegiendo su salud. Con el concepto de tamaños de mango para destornilladores de Wiha, ofrecemos cuatro tamaños y longitudes de mango adaptadas de manera óptima a los respectivos casos de atornillado y tareas de trabajo que garantizan un trabajo que protege su salud. En el concepto de mango de alicates Wiha Inomic®, un "mango de pistola" con forma acodada se encarga de que la muñeca esté descargada durante el trabajo.

Ambos conceptos de mango ayudan a los usuarios a reducir o incluso a evitar molestias en el aparato locomotor y dolores en las articulaciones y los músculos. El resultado: con Wiha se trabaja de un modo más sencillo, la fatiga tarda más en aparecer, con más eficiencia y simplemente hace que uno se sienta mejor después del trabajo. Como reza el lema de nuestro logotipo de promoción: "¡Me siento Wiha!"

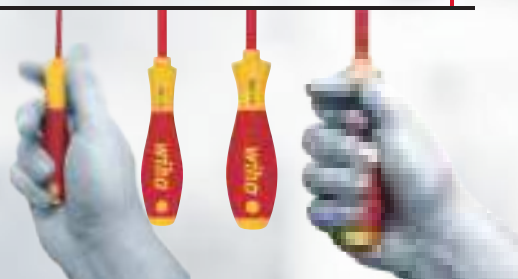
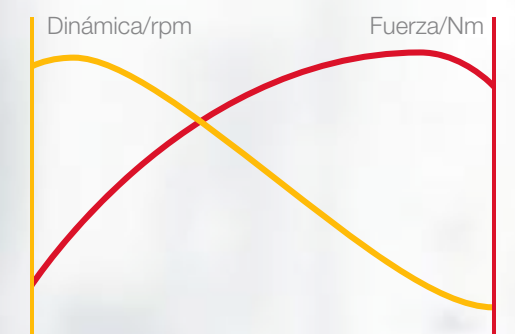

### Tamaños de mango SoftFinish® de Wiha

Cada mango de Wiha ofrece una relación entre el guiado, la velocidad y el par de apriete, adaptada de manera óptima a la tarea de atornillado.

Giro rápido: consideración consecuente de las capacidades dinámicas de los dedos.

Máxima transmisión de fuerzas, cómoda y sin pérdidas.

# Herramientas con aislamiento VDE de Wiha: Le permitirán trabajar de un modo más seguro, eficiente y protegiendo el cuerpo.

## Seguridad probada – Nuestros procedimientos de control de seguridad según IEC

**Comprobación de tensión:** Todas las herramientas VDE de Wiha con el distintivo especial han sido probadas individualmente a 10.000 V CA y están autorizadas para operar a 1.000 V CA y a 1.000/1.500 V CC.

**Prueba de congelación:** Enfriamiento hasta  $-25^{\circ}\text{C}$ . El material aislante debe mantener la resistencia para no romperse a causa de golpes y choques.

**Prueba de capacidad de aislamiento eléctrico:** Almacenamiento en agua durante 24 horas y a continuación, realización de una prueba de 3 min. a 10.000 V CA. No deberá producirse ni una descarga eléctrica ni una interrupción

**Prueba de adhesividad de la capa de material aislante:** Almacenamiento durante 168 horas a  $70^{\circ}\text{C}$  y a continuación, comprobación de la adhesividad con 500 N.

**Pruebas de presión:** Comprobación con una carga por compresión de 20 N, a una temperatura de  $70^{\circ}\text{C}$  y una tensión de ensayo de 5.000 V de CA. No deberá producirse interrupción.

**Prueba de comportamiento en combustión:** Las herramientas se exponen durante 10 s a una llama. A continuación, el material aislante debe apagarse y no seguir ardiendo.

## Indicación de seguridad

Para todos los trabajos en la cercanía o con piezas sometidas a tensión deberá utilizar las medidas de protección que correspondan a cada trabajo:

- equipos de protección individual aislantes
- dispositivos de protección aislantes
- herramientas aisladas

Antes del comienzo de los trabajos en componentes activos de equipos eléctricos y medios de producción sometidos a tensión, deberá asegurarse de que no haya tensión y durante la realización de dichos trabajos.

Esto es así si se cumplen las cinco reglas de seguridad:

- Desconectar
- Asegurar que no haya reconexión
- Asegurarse de que no haya tensión
- Conectar a tierra y poner en cortocircuito
- Recubrir o aislar los componentes cercanos sometidos a tensión

Homologadas por el instituto de control y certificación VDE y comprobadas individualmente según la norma internacional IEC 60900:2012.



---

Como instituto internacional reconocido, el VDE es responsable de la comprobación y la certificación de productos electrotécnicos. En Wiha los profesionales encuentran una amplia gama de productos VDE especialmente desarrollados para electricistas y permanentemente optimizados que ofrece soluciones de problemas orientadas a las aplicaciones para la práctica diaria.

El sistema de gestión de calidad Wiha según ISO 9001:2015 asegura que solo se producen mercancías de primera calidad y que usted pueda trabajar con productos con una calidad excelente. Con el fin de ofrecerle la máxima seguridad, la gama VDE completa de Wiha debe pasar los controles y las pruebas de unidades individuales más exigentes. Todas las herramientas VDE de Wiha han sido certificadas en varias ocasiones: El distintivo GS VDE certifica la seguridad frente a cualquier peligro desde eléctrico a radiológico. Los productos identificados con el doble triángulo y alcance de tensiones son adecuados para el trabajo en piezas bajo tensión. La norma internacional IEC 60900 define la estructura, la seguridad y los ensayos individuales, en serie y aleatorios de las herramientas aisladas.

Sin embargo, con Wiha no solo trabajará de un modo más seguro, sino también más sano y eficiente. Las geometrías ergonómicas desarrolladas especialmente ofrecen una manipulación cómoda y que protege el cuerpo. El resultado: un trabajo más sencillo, menos signos de fatiga, más eficiencia.



**SHOWTIME**

**LAS ESTRELLAS PARA TODAS LAS  
APLICACIONES**



**LAS ESTRELLAS PARA LOS  
ELECTRICISTAS**





# LAS ESTRELLAS PARA LOS MECÁNICOS



## Contenido



**Juego de caja de herramientas XXL II electric**

Página 97



**Juego de herramientas para técnicos de servicio**

Página 100



**Juego de herramientas slimVario® electric**

Página 101



**Juego de herramientas para electricistas**

Página 102



**Destornillador eléctrico speedE® II electric**

Página 120



**Juego básico de destornillador eléctrico speedE® I electric**

Página 120



**Juego de destornilladores eléctricos speedE® electric Industrial**

Página 123



**Linterna con LED, láser y luz UV**

Página 124



**Juego de destornilladores y bits slimVario®**

Página 130



**Juego de bits slimBit electric**

Página 136



**Destornillador SoftFinish® electric slimFix**

Página 140



**Destornillador SoftFinish®**

Página 147



**Juego de destornilladores dinámicos TorqueVario®-S electric**

Página 164



**Destornillador dinámico TorqueVario®-S electric**

Página 166



**Destornillador dinámico con mango corredizo TorqueVario®-S T electric**

Página 171



**Destornillador dinámico iTorque®**

Página 172



**Destornillador con cargador LiftUp electric Ranurado, Phillips con 6 slimBits, en blíster**

Página 186



**Destornillador con cargador LiftUp 26one®**

Página 187



**Destornillador con cargador Stubby**

Página 187



**Herramienta multiusos PocketStar**

Página 190



**Juego de llaves Allen en soporte ErgoStar Cabeza esférica hexagonal MagicRing®, de 10 unid., en colores luminosos**

Página 206



**Juego de llaves Allen en soporte ProStar**

Página 208



**Juego de llaves Allen en soporte ProStar**

Página 208



**Juego de llaves Allen en soporte ErgoStar**

Página 211



**Juego de bits BitBuddy®, bits en TY de 49 mm Pozidriv de 8 unid. de 1/4" E6,3**

Página 232



**Juego de bits XLSelector, bits en T de 25 mm**

Página 236



**Juego de bits XLSelector, bits en Y de 25 mm**

Página 238



**Juego de bits, bit TY de 29 mm**

Página 235



**Juego de llaves de vaso y bits 1/4" y 1/2" 60 unid. con L-Boxx**

Página 266



**Juego de llaves de vaso y bits de 1/4" Bolsa funcional de 40 unid. con clip para el cinturón**

Página 267



**Juego de llaves de carraca de 1/4" 17 unid. con plantilla de espuma**

Página 268



**Juego de llaves de carraca de 1/2" 26 unid. con plantilla de espuma**

Página 268



**Alicates de instalación TriCut Professional electric**

Página 275



**Alicates de corte diagonal de alto rendimiento BiCut® Professional con DynamicJoint®**

Página 276



**Pinza pico de loro Professional electric**

Página 282



**crimpadora automática**

Página 287



**Juego de martillos de cara blanda Safety**

Página 324



**Martillo de cara blanda Safety de dureza media/duro**

Página 325



**Martillo de cara blanda sin contragolpe, semiduro**

Página 328



**Martillo de electricista**

Página 330



**Herramienta pelacables y crimpadora, juego de 4 unid. con elementos de unión 2600 ud. codificación por colores DIN en caja surtida**

Página 336



**Herramienta pelacables y crimpadora, juego de 5 unid.**

Página 337



**Expositor de extremos de cable**

Página 338



**Extremo del cable con cuello de plástico, juego**

Página 339



**Juego de llaves de carraca aisladas de 1/2"**  
Página 105



**Juego de llaves planas de una boca aisladas de 6 - 32 mm**  
Página 106



**Juego de herramientas para mecánicos**  
Página 111



**Juego de herramientas ESD**  
Página 113



**Comprobador de tensión con detector de voltaje protegido contra explosión, sin contacto, unipolar 12 - 1.000 V CA**  
Página 125



**Juego de comprobador de par de apriete Torque QuickCheck**  
Página 126



**Comprobador de tensión y paso, 12-1.000 V CA, CAT IV**  
Página 125



**Destornillador SoftFinish®**  
Página 152



**Juego de destornilladores de precisión PicoFinish®**  
Página 153



**Destornillador MicroFinish**  
Página 156



**Destornillador SoftFinish® ESD**  
Página 158



**Destornillador dinamométrico TorqueFix®**  
Página 174



**Destornillador dinamométrico con mango en T TorqueVario®-S T**  
Página 178



**Destornillador dinamométrico TorqueVario®-S ESD**  
Página 181



**Inserto de llave de vaso Gripper**  
Página 194



**Juego de destornilladores con varillas intercambiables SYSTEM 6**  
Página 195



**Juego de destornilladores con varillas intercambiables SYSTEM 4 ESD,**  
Página 202



**Juego de destornilladores con varillas intercambiables SYSTEM 4**  
Página 200



**Juego de llaves Allen en soporte ProStar**  
Página 214



**Juego de llaves Allen en soporte Classic**  
Página 214



**Llave Allen con mango corredizo Comfort grip**  
Página 216



**Llave Allen con mango de llave**  
Página 217



**Juego de bits, bit T de 25 mm**  
Página 237



**Juego de bits, bit Y de 25 mm**  
Página 240



**Bit Professional**  
Página 250



**Portabits Porta-Puntas con bloqueo mecánico**  
Página 260



**Juego de llaves de boca con carraca angular**  
Página 270



**Juego de llaves de boca con carraca angular**  
Página 270



**Juego de llaves de boca con carraca angular**  
Página 271



**Juego de llaves planas de doble boca**  
Página 271



**Herramienta pelacable automática**  
Página 284



**Alicates de corte diagonal de alto rendimiento BiCut® Professional con DynamicJoint®**  
Página 291



**Tenazas llave Classic**  
Página 300



**Juego de alicates Professional ESD**  
Página 308



**Juego de destornilladores-perforadores de agujeros para espigas SoftFinish® con espigas**  
Página 330



**Nivel de burbuja de aire para electricistas de 40 cm**  
Página 331



**Metro plegable para electricista Longlife 2 m**  
Página 332



**Extremo del cable gemelo con cuello de plástico, juego**  
Página 339



**Extremo del cable con cuello de plástico, juego**  
Página 340



**Extremo del cable gemelo con cuello de plástico**  
Página 342



**Terminal de cable plano forma anular aislado**  
Página 344



**Juego de caja de  
herramientas XXL III  
electric en surtido,  
de 106 unid. incl. caja  
de herramientas**

N° pdo. 44128

Página 97





Carro para transitar por terrenos difíciles y escaleras



Función de banco de trabajo y escalón



Incisión en forma de V con escala en la tapa



El complemento perfecto!

Destornillador eléctrico speedE® II electric  
Nº pdo. 44318 Página 120



Posición de extracción elevada



DOCTORS  
RECOMMEND



Destornillador recomendado por profesionales  
de la medicina y terapeutas



**Juego de herramientas  
para electricistas  
Competence XL**

Nº pdo. 40523

Página 98



Caja robusta



Incluye herramienta dinamométrica aislada



## Juego de herramientas slimVario® electric

N° pdo. 43465

Página 101



Función de soporte de banco de trabajo



Completo sistema aislado de puntas intercambiables



**Destornillador eléctrico**

**speedE® II electric**

N° pdo. 44318

Página 120

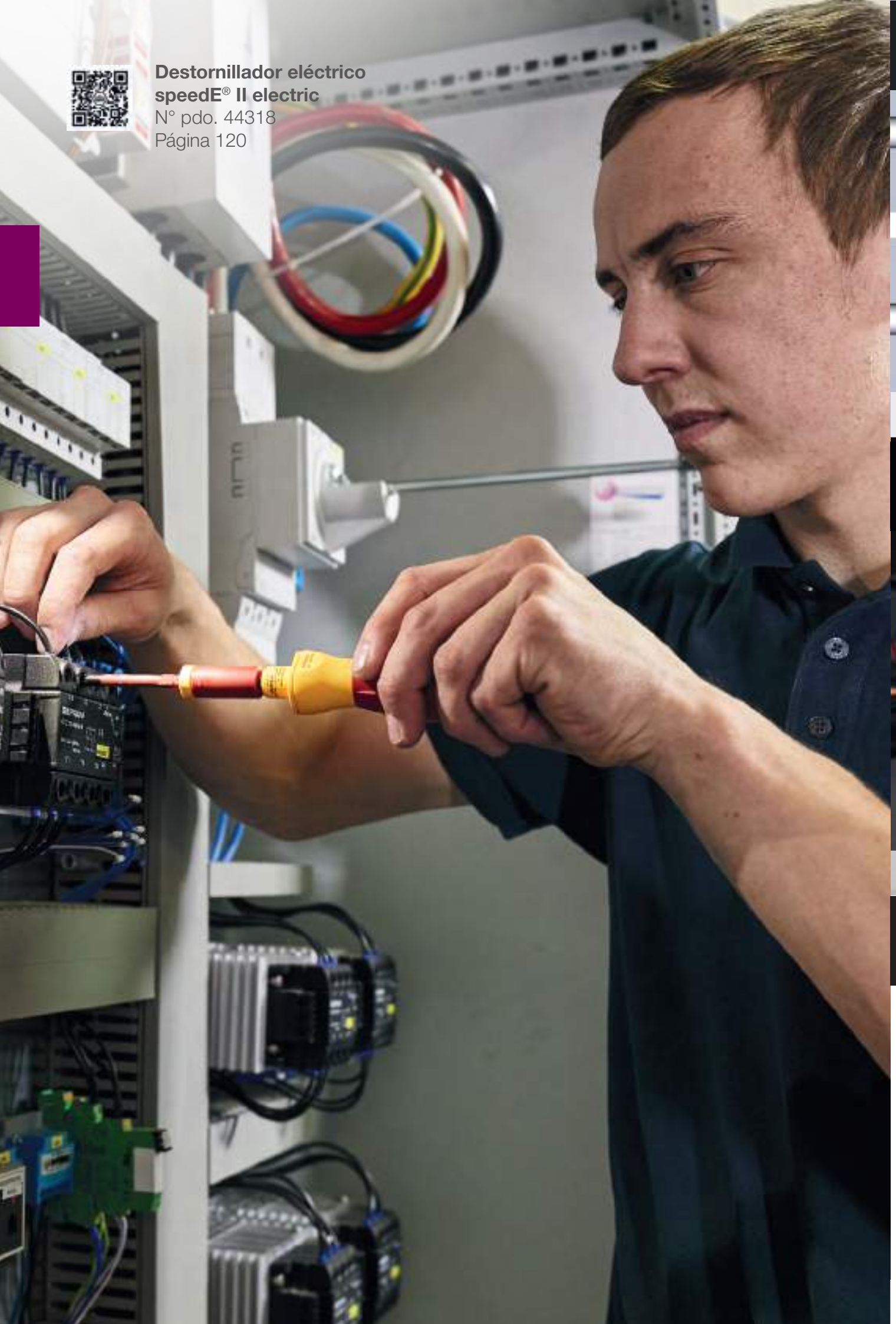

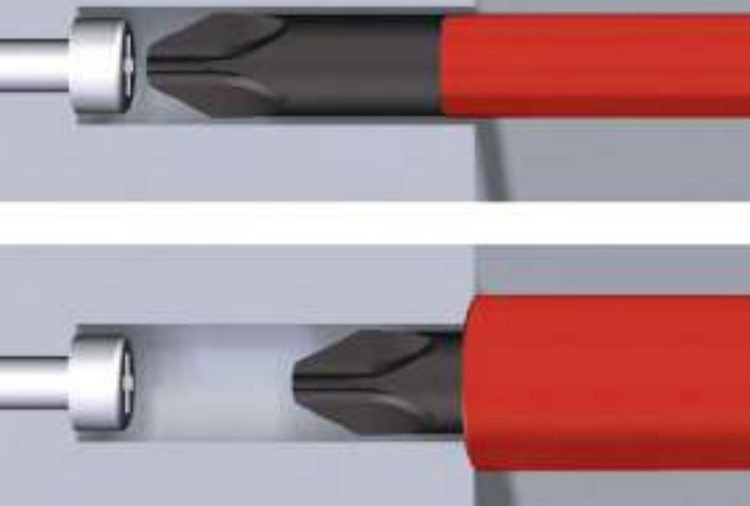

slimBits aislados



Manejo en cualquier posición gracias a su interruptor anular



Iluminación sin sombras



El complemento perfecto!

Destornillador con cargador LiftUp electric  
N° pdo. 41234 Página 186



Destornillador recomendado por profesionales de la medicina y terapeutas



1000V  
APPROVED



Herramientas seguras homologadas según VDE hasta 1000 V CA

**Linterna con LED,  
láser y luz UV**  
N° pdo. 41286  
Página 124





Base magnética y clip de sujeción



Cabezal giratorio



3 en 1: potente lámpara LED, función láser y luz UV

**Juego de comprobador  
de par de apriete Torque  
QuickCheck**

N° pdo. 42086

Página 126



Comprobación de herramientas dinámicas en cualquier lugar



Fácil verificación con señalización tipo semáforo





**Juego de  
destornilladores  
y bits slimVario®**

N° pdo. 41231

Página 130



Incluye estuche robusto

Completo sistema aislado de puntas intercambiables



Comprobación rápida y sin contacto



Punta de medición con ajuste internacional, apta para uso en todo tipo de tomas de corriente



**Comprobador de tensión  
con detector de voltaje  
protegido contra explosión,  
sin contacto, unipolar  
12 – 1.000 V CA**  
N° pdo. 44309  
Página 125

**Comprobador de tensión  
con detector de voltaje,  
sin contacto, unipolar,  
12 – 1.000 V CA**  
N° pdo. 43797  
Página 125



**Juego de  
destornilladores  
SoftFinish® electric  
slimFix en surtido  
de 12 unid.**

N° pdo. 41003

Página 131

- Diseño de mango ergonómico recomendado por profesionales de la medicina y terapeutas
- Herramientas seguras homologadas según VDE hasta 1000 V CA
- slimBits aislados



wiha

P12 x 100  
3241



**Juego de  
destornilladores con  
portabits electric  
slimVario®**

N° pdo. 41230

Página 134



Magno compacto, máxima potencia



Completo sistema aislado de puntas intercambiables



**Juego de  
destornillador de  
precisión PicoFinish®  
slimVario® electric**

N° pdo. 43167  
Página 134



Completo sistema aislado de puntas intercambiables



Para una transmisión de fuerzas precisa y controlada

**Juego de bits  
slimBit electric TORX®,  
TORX PLUS®, dde 15 unid.,  
incl. cajas de slimBits y clip  
N° pdo. 43161  
Página 136**







Herramientas seguras homologadas según VDE hasta 1000 V CA



**El complemento perfecto!**  
Destornillador eléctrico speedE® II electric  
N° pdo. 44318 Página 120



## Juego de destornilladores

**SoftFinish®**

N° pdo. 41002

Página 149

- Concepto único de tamaños de mango de Wiha con equilibrio óptimo entre fuerza y control
- Diseño de mango ergonómico recomendado por profesionales de la medicina y terapeutas



wiha

T30 x115  
362





**Juego de  
destornilladores  
SoftFinish®**

N° pdo. 21250

Página 145



Con caperuzón de montaje continuo



**DOCTORS  
RECOMMEND**



Diseño de mango ergonómico recomendado  
por profesionales de la medicina y terapeutas



## Juego de destornilladores MicroFinish

N° pdo. 29138

Página 156



Con caperuzón de montaje continuo



Diseño de mango ergonómico recomendado por profesionales de la medicina y terapeutas



**Juego de  
destornilladores  
SoftFinish® ESD**  
N° pdo. 27252  
Página 157

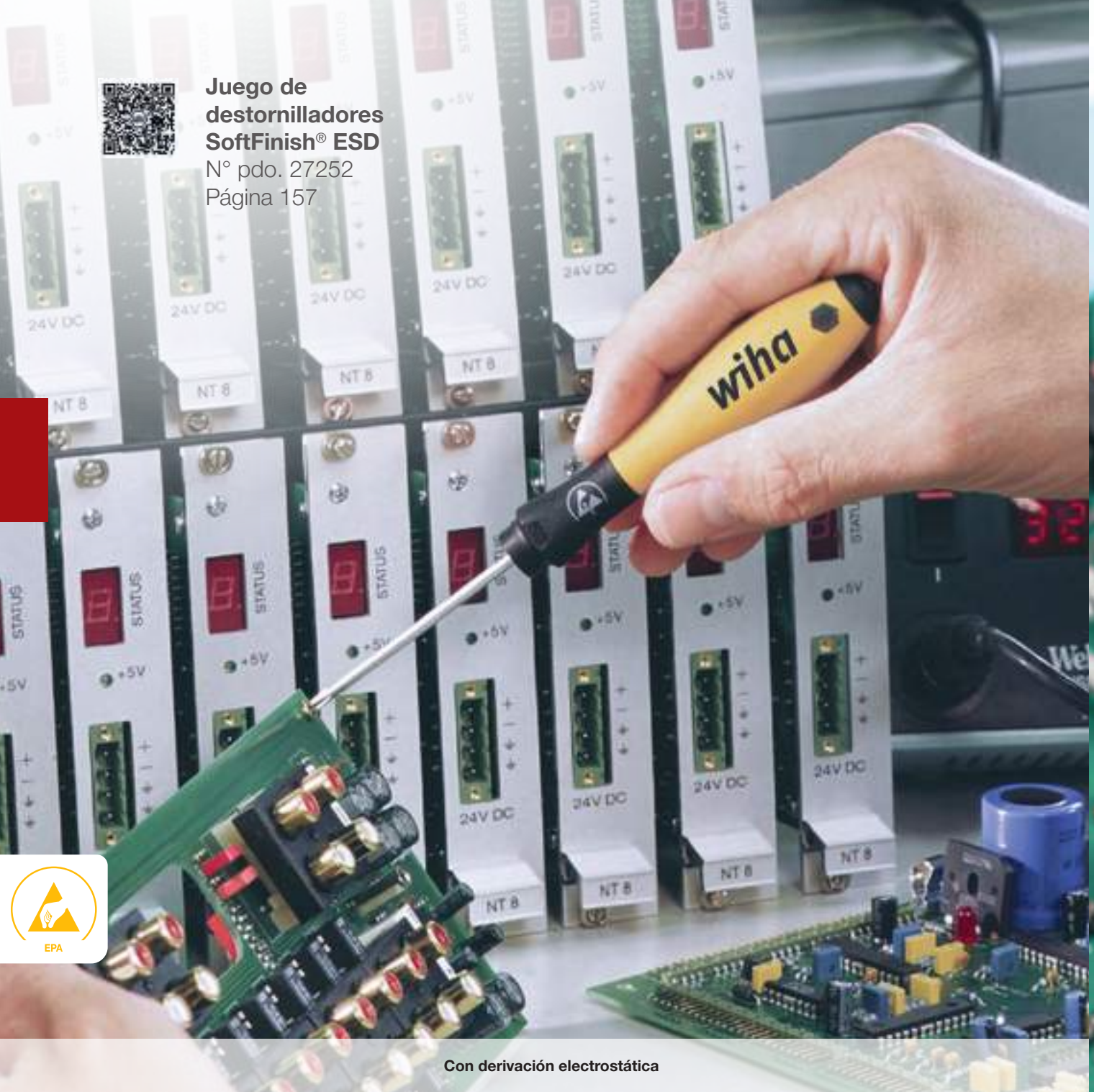

Con derivación electrostática



Diseño de mango ergonómico recomendado por profesionales de la medicina y terapeutas

**Juego de  
destornilladores de  
precisión PicoFinish®  
ESD ranurados,  
Phillips, de 7 unid.,  
incl. soporte**  
N° pdo. 43707  
Página 158

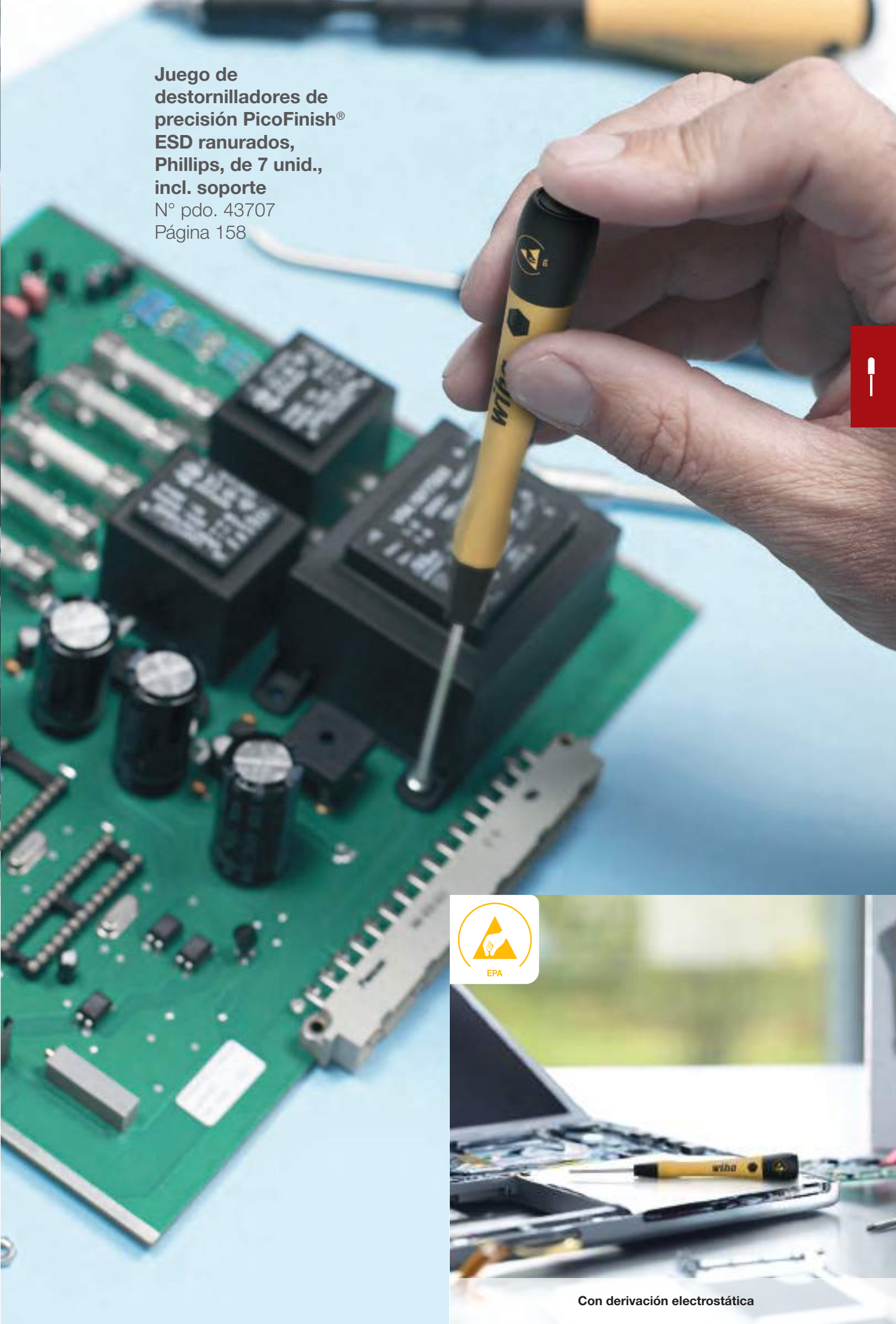

Con derivación electrostática



**Juego de destornilladores  
dinamométricos TorqueVario®-S  
electric**

N° pdo. 36791

Página 164





Incluye estuche robusto



Protege frente a cualquier reclamación por garantía

**Destornillador  
dinamométrico con  
mango corredizo**  
**TorqueVario®-S T electric**  
N° pdo. 43177  
Página 171



Par de apriete de ajuste variable



Protege de posibles daños al material y reduce la necesidad de realizar trabajos de repaso



Mango corredizo para transmisión de fuerzas elevada



Protege frente a cualquier reclamación por garantía



Protects material from damage and ensures no additional follow-up work



**El complemento perfecto!**

Juego de llaves Allen en soporte ErgoStar  
N° pdo. 37351 Página 207





**Destornillador  
dinamométrico  
iTorque®**  
N° pdo. 36888  
Página 172



Juego de  
destornilladores  
dinamométricos  
TorqueVario®-S  
N° pdo. 26893  
Página 173



Par de apriete de ajuste variable



Incluye caja metálica robusta

**Juego de  
destornilladores  
dinamométricos  
con mango en T  
TorqueVario®-ST**

Nº pdo. 29233

Página 178



Incluye caja metálica robusta



Par de apriete de ajuste variable

Juego de destornilladores dinámicos  
TorqueVario®-S ESD 0,4-1,0 Nm en surtido,  
de 14 unid., con limitación del par de apriete  
de ajuste variable, incl. caja

N° pdo. 43898

Página 181







Par de apriete de ajuste variable



Con derivación electrostática



Diseño de mango ergonómico recomendado por profesionales de la medicina y terapeutas



**Destornillador con  
cargador LiftUp electric**

N° pdo. 38610

Página 186





- 6 herramientas en una
- Almacenamiento seguro de todos los bits
- Herramientas seguras homologadas según VDE hasta 1000 V CA
- slimBits aislados



**Destornillador con  
cargador LiftUp 26one®**  
N° pdo. 43895  
Página 187



Mango grande, máxima potencia



26 herramientas en una



Imprescindible en cualquier casa



**Destornillador con  
cargador magnético**

N° pdo. 33736

Página 189



Perfecto para lugares estrechos



6 herramientas en una



**Herramienta multiusos  
PocketStar en surtido  
de 9 unid.**

N° pdo. 25293  
Página 190



Uso como mango largo o transversal



Incluye todas las tomas de fuerza más usuales





**Inserto de llave de vaso  
Gripper**  
N° pdo. 20554  
Página 194



Agarra diferentes perfiles y contornos



**El complemento perfecto!**  
Juego de alicates Professional  
N° pdo. 26854 Página 289



Solucionador de problemas



**Juego de destornilladores  
con varillas intercambiables  
SYSTEM 6 en surtido, de 12  
unid., incl. bolsa enrollable**  
N° pdo. 03591  
Página 195

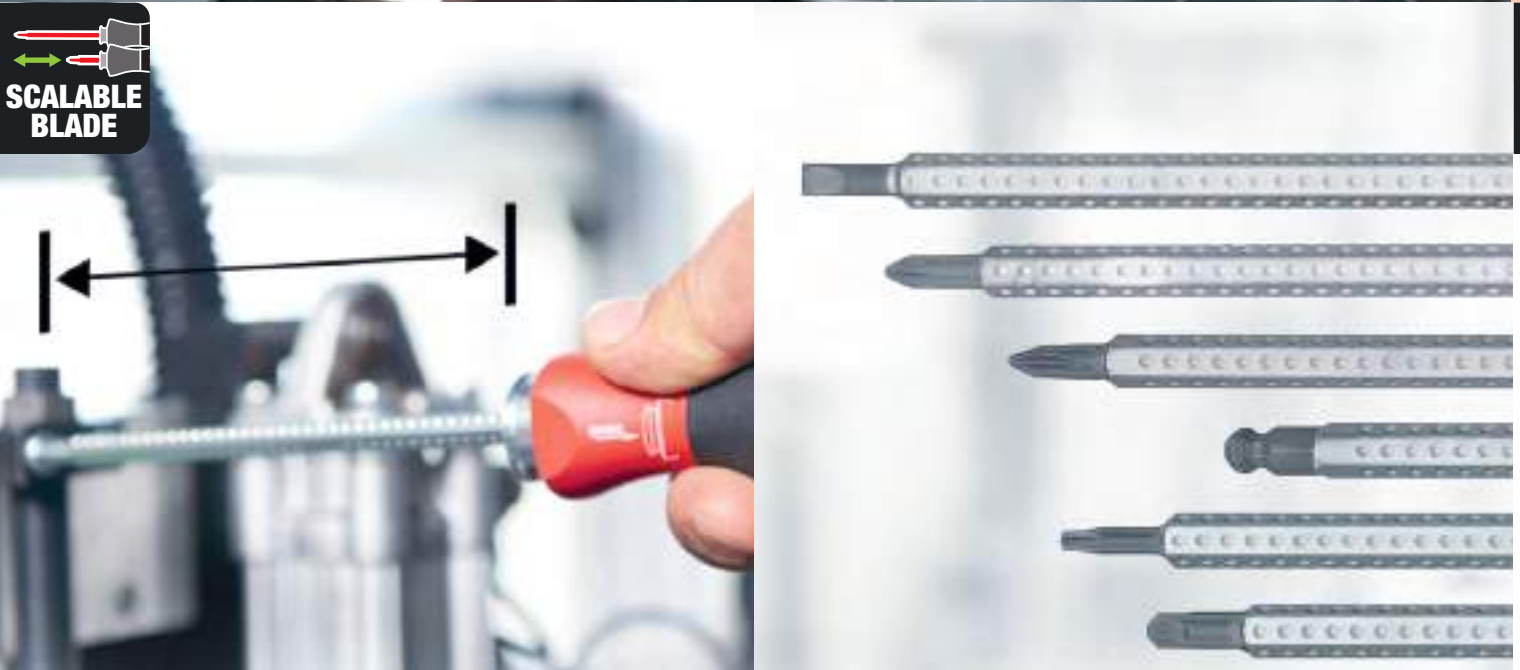

Longitud de varilla de ajuste variable

Amplia gama de varillas intercambiables

Juego de  
destornilladores con  
varillas intercambiables  
SYSTEM 4 ESD

en surtido de 12 unidades

incl. bolsa enrollable

N° pdo. 31499

Página 202

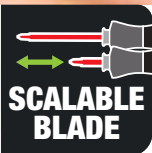

Longitud de varilla de ajuste variable



Amplia gama de varillas intercambiables

- Cabeza esférica de 25°
- Almacenamiento perfecto en todo momento
- Fácil de encontrar gracias a la pintura luminosa con luz UV
- Sujeta tornillos hexagonales sin imán



**Juego de llaves Allen  
en soporte ErgoStar**

N° pdo. 43850

Página 206



**Juego de llaves Allen  
en soporte ErgoStar**

N° pdo. 43851

Página 207

**Juego de llaves Allen  
en soporte ErgoStar  
TORX® MagicSpring®,  
con cabeza esférica,  
de 14 unid., acabado  
en oxidación negra,  
en blister**

N° pdo. 43848

Página 211

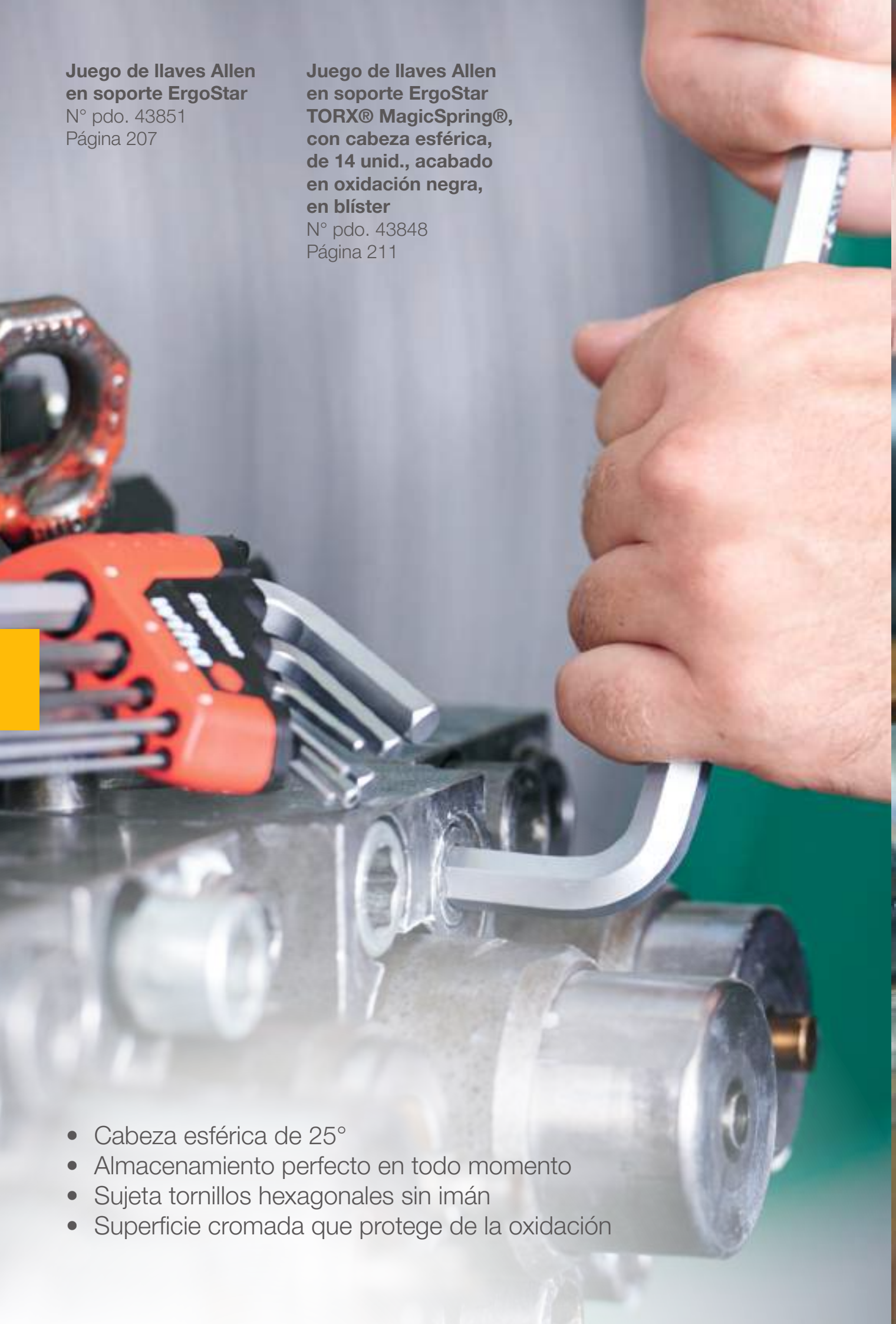

- Cabeza esférica de 25°
- Almacenamiento perfecto en todo momento
- Sujeta tornillos hexagonales sin imán
- Superficie cromada que protege de la oxidación



**Juego de llaves Allen  
en soporte ProStar**  
Best.-Nr 35481  
Página 208

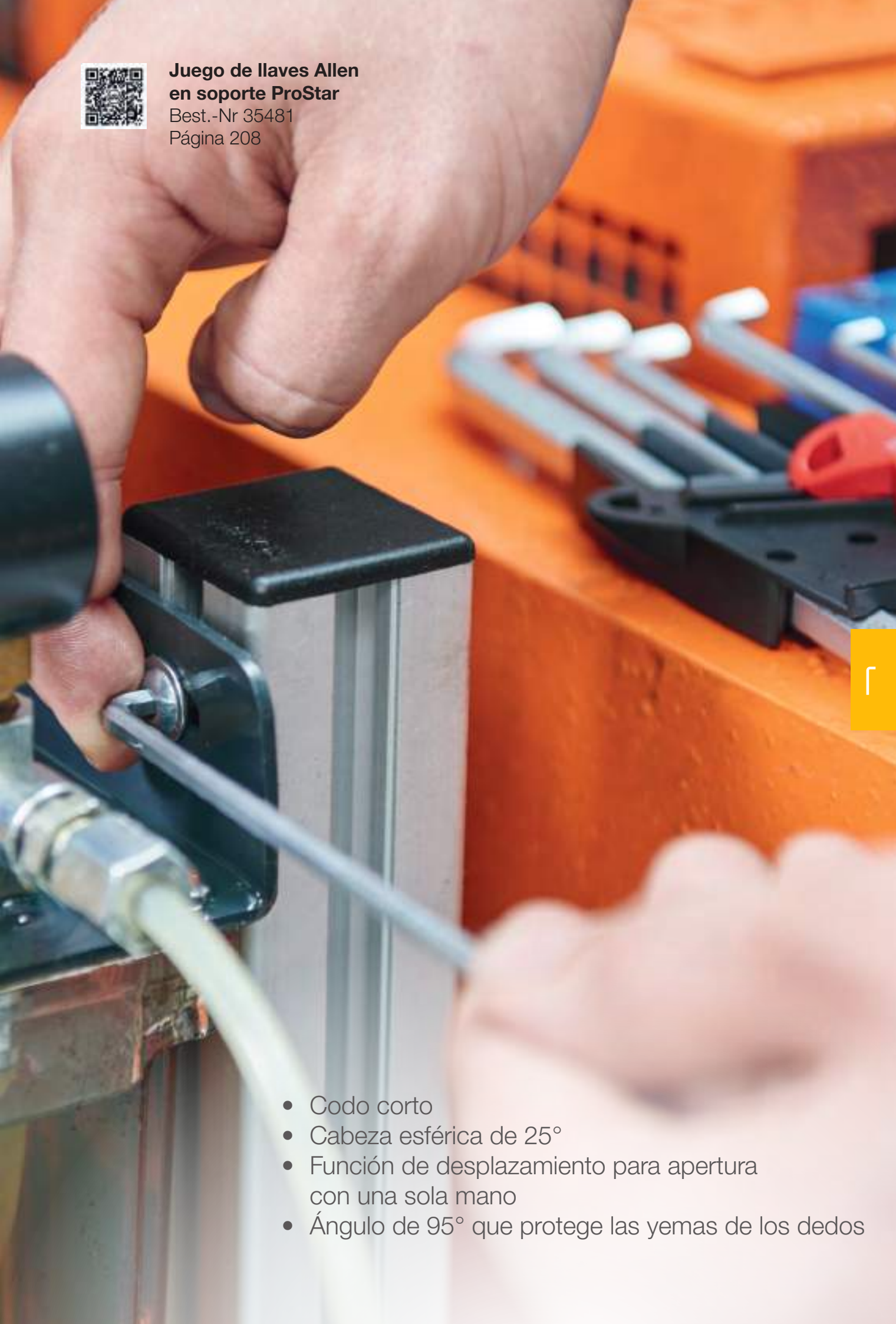

- Codo corto
- Cabeza esférica de 25°
- Función de desplazamiento para apertura con una sola mano
- Ángulo de 95° que protege las yemas de los dedos

**Juego de llaves Allen con mango en T Comfort grip hexagonales, de 6 unid., con acoplamiento lateral, en cromado mate**

N° pdo. 26247

Página 216

**Juego de llaves Allen con mango en T Comfort grip TORX®, de 6 unid., con acoplamiento lateral, en cromado mate**

N° pdo. 26248

Página 216

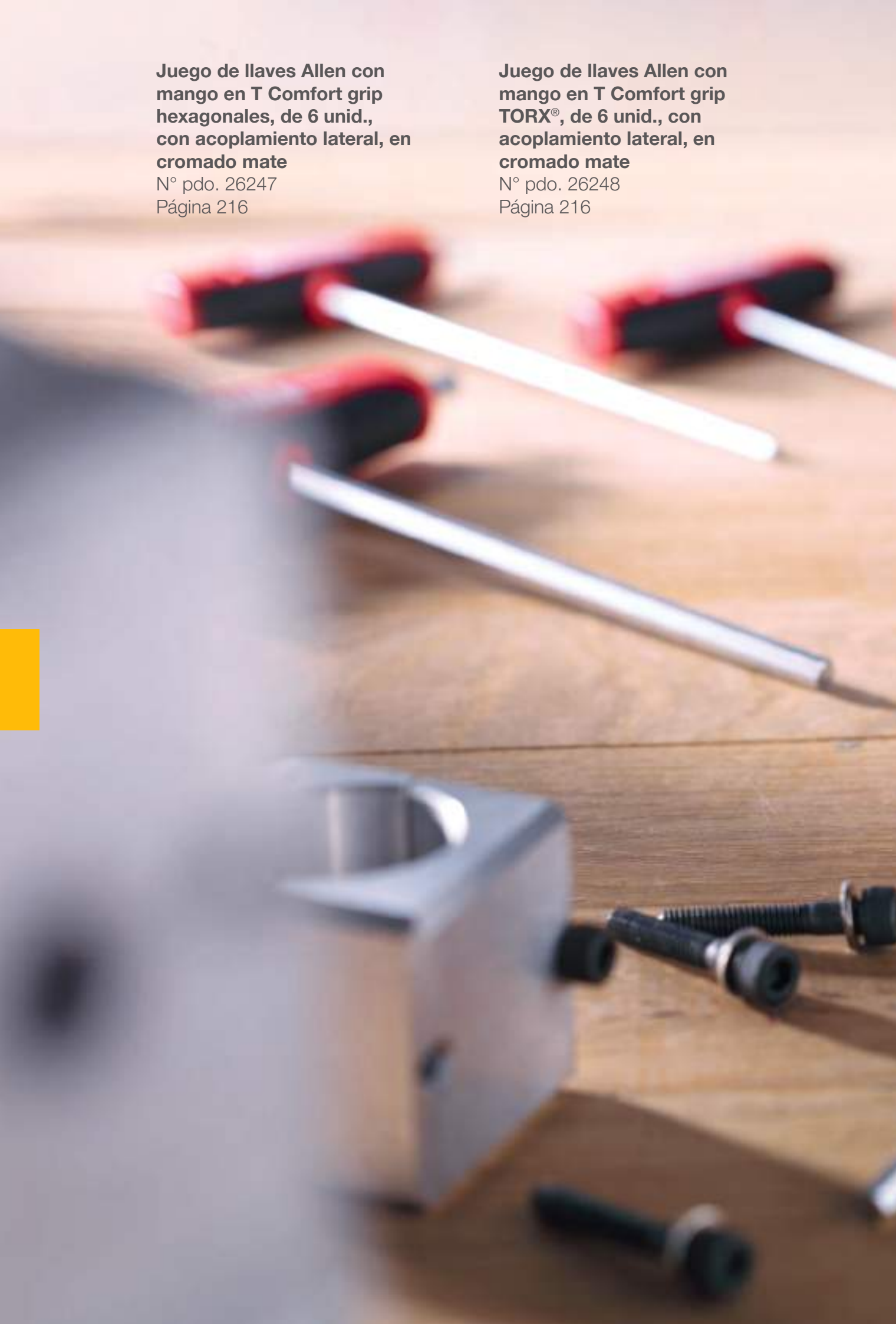





- Mango corredizo para transmisión de fuerzas elevada
- Con toma de fuerza lateral integrada
- Superficie cromada que protege de la oxidación



**Juego de bits BitBuddy®,  
bits en TY de 29 mm TORX®,  
de 9 unid. de 1/4" C6,3**

N° pdo. 42136

Página 234

**Juego de bits BitBuddy®,  
bits en TY de 49 mm TORX®,  
de 8 unid. de 1/4" E6,3**

N° pdo. 42115

Página 232





- Vida útil multiplicada por 120
- Fácil de encontrar gracias a la pintura luminosa con luz UV
- Extracción rápida y sencilla de los bits



**Juego de bits  
FlipSelector, bits en Y  
de 25 mm TORX®, de  
14 unid. de 1/4" C6,3**  
N° pdo. 41828  
Página 239

**Juego de bits  
XLSelector, bits en  
Y de 25 mm Phillips,  
Pozidriv, TORX®, de 32  
unid. de 1/4" C6,3**  
N° pdo. 41832  
Página 238



Vida útil multiplicada por 120



Fácil de encontrar gracias a la pintura luminosa con luz UV



**Juego de bits  
FlipSelector, bits en  
T de 25 mm Phillips,  
Pozidriv, TORX®, de 14  
unid. de 1/4" C6,3**  
N° pdo. 41824  
Página 236



**Portabits Porta-Puntas  
con bloqueo  
mecánico 1/4",  
magnético en caja**

N° pdo. 39133

Página 260



**Portabits MagicFlip  
Force magnético  
con imán anular,  
de 1/4" en caja**

N° pdo. 36800

Página 260





**Portabits Porta-Puntas  
Super Slim con  
bloqueo mecánico  
1/4" en caja**

N° pdo. 39134

Página 260





**Juego de llaves de vaso y bits de 1/4" Bolsa funcional de 40 unid. con clip para el cinturón**

N° pdo. 44684

Página 267



5°  
72  
RATCHET



1/4"

Minicarraca con dentado fino, con giro derecha-izquierda

Juego de llaves de vaso 1/4" de alta calidad, para trabajos fuera del taller





**Juego de llaves de vaso y bits 1/4" y 1/2"**  
**60 unid. con L-Boxx**  
N° pdo. 44685  
Página 266



**1/4"**

**1/2"**



Juegos de llaves de vaso 1/4" y 1/2" y juego de carracas de alta calidad



Acceso rápido gracias a su sistema de ordenación



**Alicates de corte diagonal  
de alto rendimiento  
BiCut® Professional con  
DynamicJoint® conmutables**

N° pdo. 38984

Página 276





**Alicates de instalación**  
**TriCut Professional electric**  
N° pdo. 38552  
Página 275



**Juego de alicates Professional electric con alicates universales, de boca semi-redonda, alicates de corte diagonal, de 3 unid.**

N° pdo. 26852

Página 274



0%  
wer

DynamicJoint® reduce el esfuerzo



Superficie cromada que protege de la oxidación

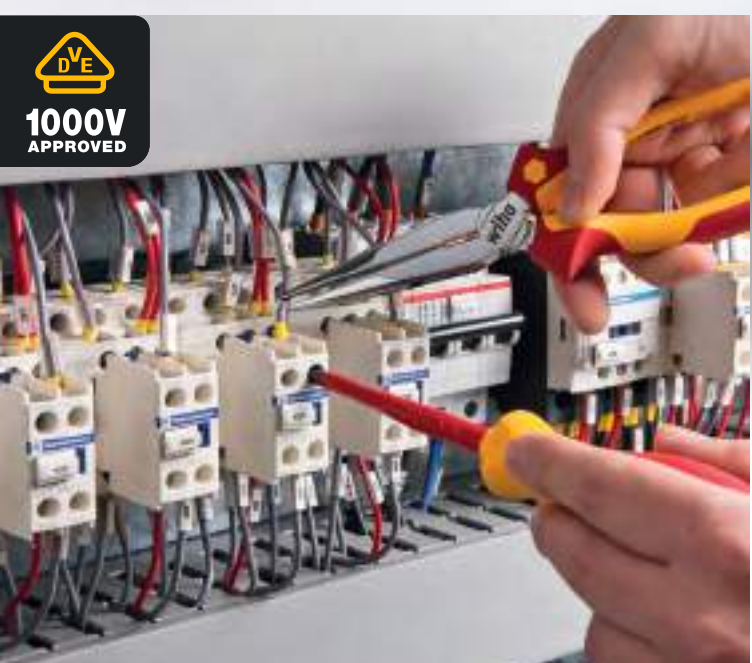

Herramientas seguras homologadas según VDE hasta 1000 V CA

**Herramienta pelacable automática  
hasta 16 mm<sup>2</sup> en blíster**

N° pdo. 42062

Página 284



**Crimpadora automática  
para extremos de cables,  
con presión hexagonal**

N° pdo. 41246

Página 286

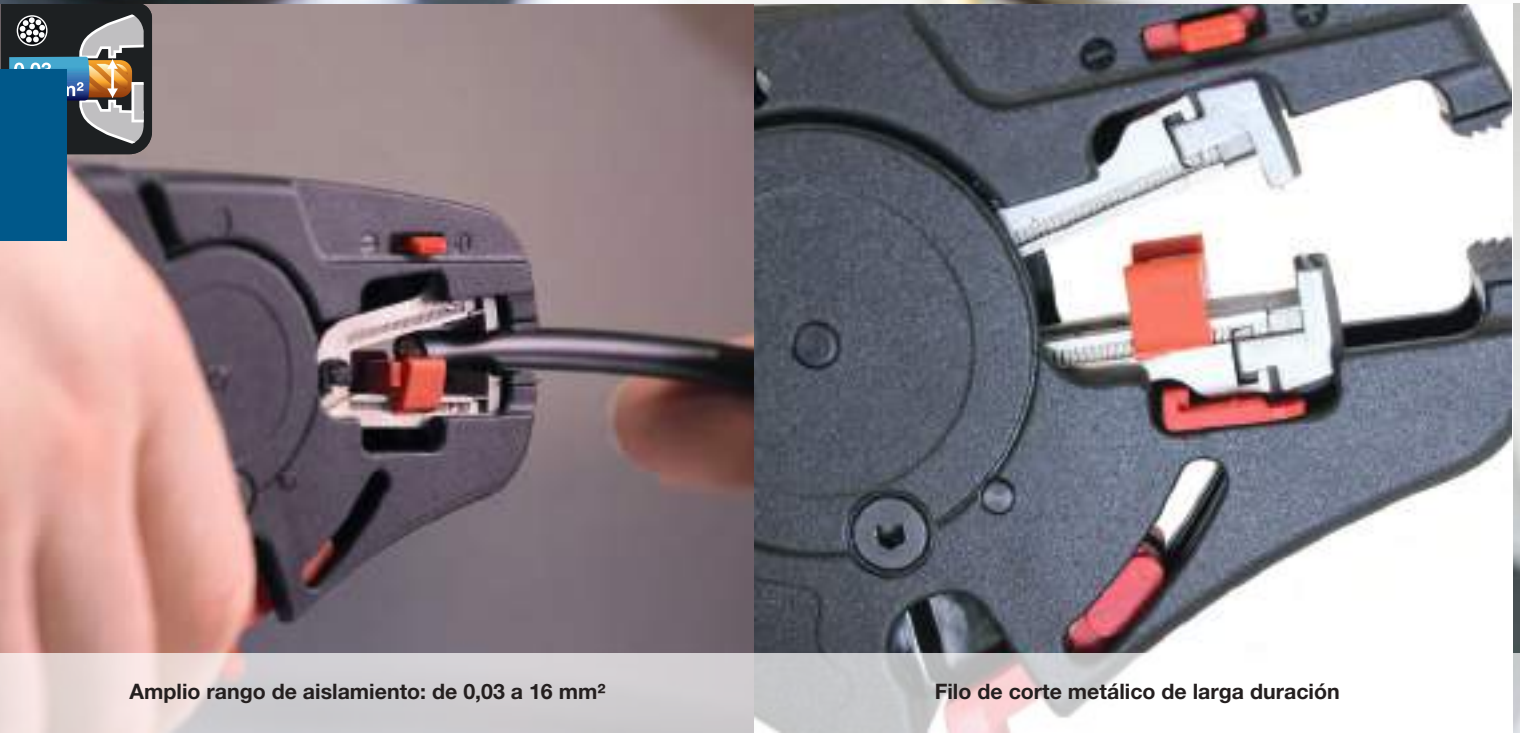

Amplio rango de aislamiento: de 0,03 a 16 mm<sup>2</sup>

Filo de corte metálico de larga duración



Amplio rango de crimpado: de 0,08 a 16 mm<sup>2</sup>



Crimpado hexagonal de alta calidad



## Tenazas llave Classic

N° pdo. 40923

Página 300



Frenado automático a partir del ancho de llave 17



Aptas para zurdos





Mordazas lisas para superficies delicadas



Atornillado rápido mediante función de trinquete



Juego de alicates  
Professional Alicates  
universales de fuerza,  
alicates para fontanería,  
alicates de corte diagonal  
de fuerza, de 3 unid.

N° pdo. 26854

Página 289



DynamicJoint® reduce el esfuerzo

Tres alicates para muchas aplicaciones



**Juego de alicates  
Classic con MagicTips®  
con alicates de  
arandelas de  
seguridad, de 4 unid.**  
N° pdo. 34708  
Página 290



Anillos de seguridad sujetos de forma segura y fija



Alicates de corte diagonal  
de alto rendimiento  
BiCut® Professional con  
DynamicJoint® conmutables  
N° pdo. 38190  
Página 291



2 IN 1

200%  
OFF ON  
Power

Dos herramientas en una

Reduce a la mitad el esfuerzo

**Juego de alicates Profesional  
ESD con alicates de corte  
diagonal, de corte frontal  
transversal, alicates de boca  
semi-redonda, de 5 unid.  
incl. carpeta de herramientas**  
N° pdo. 33507  
Página 308



Con derivación electrostática



**Juego de destornilladores-  
perforadores de agujeros para  
espigas SoftFinish® con  
espigas con varilla redonda de  
6 mm, en blíster, de 5 unid.**

N° pdo. 41289

Página 330

- Trabajo sin suciedad ni polvo
- Con escala láser para medición de profundidad
- Separación galvánica en el mango
- Agujero para espigas por golpe de martillo





**Martillo de electricista  
con cabeza del martillo  
de 300 g, en blíster**

N° pdo. 42071

Página 330

- Con orejas planas
- Distribución óptima del peso
- Ideal para lugares estrechos



**Juego de martillos de cara blanda Safety con surtido de cabezales, de 8 unid., en caja**

N° pdo. 44008

Página 324

- Cabezas intercambiables
- Reduce el esfuerzo
- Mango de madera de pacana





**Martillo de cara blanda  
sin contragolpe,  
semiduro con tubo de  
acero, cabezal redondo**

Nº pdo. 02122

Página 328

- Cabezas intercambiables
- Reduce el esfuerzo
- Martillado sin contragolpe





**Nivel de burbuja de aire para electricistas de 40 cm**

N° pdo. 42074

Página 331





Visibilidad perfecta de ambos niveles



Escalas posicionadas habilmente



Señalización variable de distancias



## Contenido



**Juego de caja de herramientas XXL II electric**

Página 97



**Juego de herramientas para técnicos de servicio**

Página 100



**Juego de herramientas slimVario® electric**

Página 101



**Juego de herramientas para electricistas**

Página 102



**Destornillador electric speedE® II**

Página 120



**Juego básico de destornillador electric speedE® I**

Página 120



**Juego de destornilladores electric speedE® electric Industrial**

Página 123



**Linterna con LED, láser y luz UV**

Página 124



**Juego de destornilladores y bits slimVario®**

Página 130



**Juego de bits slimBit electric**

Página 136



**Destornillador SoftFinish® electric slimFix**

Página 140



**Destornillador SoftFinish®**

Página 147



**Juego de destornilladores dinámicos TorqueVario®-S electric**

Página 164



**Destornillador dinámico TorqueVario®-S electric**

Página 166



**Destornillador dinámico con mango corredizo TorqueVario®-S T electric**

Página 171



**Destornillador dinámico iTorque®**

Página 172



**Destornillador con cargador LiftUp electric Ranurado, Phillips con 6 slimBits, en blíster**

Página 186



**Destornillador con cargador LiftUp 26one®**

Página 187



**Destornillador con cargador Stubby**

Página 187



**Herramienta multiusos PocketStar**

Página 190



**Juego de llaves Allen en soporte ErgoStar Cabeza esférica hexagonal MagicRing®, de 10 unid., en colores luminosos**

Página 206



**Juego de llaves Allen en soporte ProStar**

Página 208



**Juego de llaves Allen en soporte ProStar**

Página 208



**Juego de llaves Allen en soporte ErgoStar**

Página 211



**Juego de bits BitBuddy®, bits en TY de 49 mm Pozidriv de 8 unid. de 1/4" E6,3**

Página 232



**Juego de bits XLSelector, bits en T de 25 mm**

Página 236



**Juego de bits XLSelector, bits en Y de 25 mm**

Página 238



**Juego de bits, bit TY de 29 mm**

Página 235



**Juego de llaves de vaso y bits 1/4" y 1/2" 60 unid. con L-Boxx**

Página 266



**Juego de llaves de vaso y bits de 1/4" Bolsa funcional de 40 unid. con clip para el cinturón**

Página 267



**Juego de llaves de carraca de 1/4" 17 unid. con plantilla de espuma**

Página 268



**Juego de llaves de carraca de 1/2" 26 unid. con plantilla de espuma**

Página 268



**Alicates de instalación TriCut Professional electric**

Página 275



**Alicates de corte diagonal de alto rendimiento BiCut® Professional con DynamicJoint®**

Página 276



**Pinza pico de loro Professional electric**

Página 282



**crimpadora automática**

Página 287



**Juego de martillos de cara blanda Safety**

Página 324



**Martillo de cara blanda Safety de dureza media/duro**

Página 325



**Martillo de cara blanda sin contragolpe, semiduro**

Página 328



**Martillo de electricista**

Página 330



**Herramienta pelacables y crimpadora, juego de 4 unid. con elementos de unión 2600 ud. codificación por colores DIN en caja surtida**

Página 336



**Herramienta pelacables y crimpadora, juego de 5 unid.**

Página 337



**Expositor de extremos de cable**

Página 338



**Extremo del cable con cuello de plástico, juego**

Página 339



**Juego de llaves de carraca aisladas de 1/2"**  
Página 105



**Juego de llaves planas de una boca aisladas de 6 - 32 mm**  
Página 106



**Juego de herramientas para mecánicos**  
Página 111



**Juego de herramientas ESD**  
Página 113



**Comprobador de tensión con detector de voltaje protegido contra explosión, sin contacto, unipolar 12 - 1.000 V CA**  
Página 125



**Juego de comprobador de par de apriete Torque QuickCheck**  
Página 126



**Comprobador de tensión y paso, 12-1.000 V CA, CAT IV**  
Página 125



**Destornillador SoftFinish®**  
Página 152



**Juego de destornilladores de precisión PicoFinish®**  
Página 153



**Destornillador MicroFinish**  
Página 156



**Destornillador SoftFinish® ESD**  
Página 158



**Destornillador dinamométrico TorqueFix®**  
Página 174



**Destornillador dinamométrico con mango en T TorqueVario®-S T**  
Página 178



**Destornillador dinamométrico TorqueVario®-S ESD**  
Página 181



**Inserto de llave de vaso Gripper**  
Página 194



**Juego de destornilladores con varillas intercambiables SYSTEM 6**  
Página 195



**Juego de destornilladores con varillas intercambiables SYSTEM 4 ESD,**  
Página 202



**Juego de destornilladores con varillas intercambiables SYSTEM 4**  
Página 200



**Juego de llaves Allen en soporte ProStar**  
Página 214



**Juego de llaves Allen en soporte Classic**  
Página 214



**Llave Allen con mango corredizo Comfort grip**  
Página 216



**Llave Allen con mango de llave**  
Página 217



**Juego de bits, bit T de 25 mm**  
Página 237



**Juego de bits, bit Y de 25 mm**  
Página 240



**Bit Professional**  
Página 250



**Portabits Porta-Puntas con bloqueo mecánico**  
Página 260



**Juego de llaves de boca con carraca angular**  
Página 270



**Juego de llaves de boca con carraca angular**  
Página 270



**Juego de llaves de boca con carraca angular**  
Página 271



**Juego de llaves planas de doble boca**  
Página 271



**Herramienta pelacable automática**  
Página 284



**Alicates de corte diagonal de alto rendimiento BiCut® Professional con DynamicJoint®**  
Página 291



**Tenazas llave Classic**  
Página 300



**Juego de alicates Professional ESD**  
Página 308



**Juego de destornilladores-perforadores de agujeros para espigas SoftFinish® con espigas**  
Página 330



**Nivel de burbuja de aire para electricistas de 40 cm**  
Página 331



**Metro plegable para electricista Longlife 2 m**  
Página 332



**Extremo del cable gemelo con cuello de plástico, juego**  
Página 339



**Extremo del cable con cuello de plástico, juego**  
Página 340



**Extremo del cable gemelo con cuello de plástico**  
Página 342



**Terminal de cable plano forma anular aislado**  
Página 344



## **Gamas**

### **Herramientas hechas para los que trabajan con herramientas.**

En las herramientas de Wiha, ya se tienen en cuenta las experiencias de los usuarios durante el desarrollo de los productos. De este modo, se han creado juegos de herramientas de alta calidad para mecánicos, electricistas e ingenieros electrónicos, que han sido compuestos especialmente para satisfacer las distintas necesidades y campos de aplicación. Las herramientas, se presentan ordenadas y con una disposición clara en bolsas de herramientas compactas y robustas y están listas para el uso en cualquier situación, garantizando un trabajo especialmente sencillo y eficiente.

Es precisamente en formato de caja de herramientas, dónde las herramientas de Wiha demuestran ser acompañantes manejables y esenciales. Para ello, se han corregido los defectos de las cajas de herramientas convencionales: La caja de herramientas de Wiha, cuenta con prácticos huecos para herramientas y con un espacio de almacenamiento extra amplio para piezas pequeñas y máquinas, permitiendo el transporte de herramientas sencillo y sin esfuerzos, - una mayor comodidad y un alivio para su trabajo en todos los aspectos.

Para aplicaciones en la electricidad

**Juego de caja de herramientas XXL III electric en surtido, de 106 unid. incl. caja de herramientas**  
Página 100



**Juego de herramientas para técnicos de servicio en surtido, de 31 unid. incl. bolsa**  
Página 100



**Juego de herramientas slimVario® electric en surtido de 32 uds., incl. bolsa funcional**  
Página 101



**Juego de herramientas para electricistas en surtido, de 13 unid., incl. funda para herramientas**  
Página 102



**Juego de herramientas para electricistas con destornilladores, alicates de corte diagonal, de 7 unid., incl. funda para herramientas**  
Página 103



**Juego de herramientas para electricistas en surtido, 18 unid. incl. bolsa para cinturón**  
Página 104



**Juego de bits de montaje 20 unid., en bolsa enrollable**  
Página 114



**Juego de llaves de carraca aisladas de 1/2" de 21 unid. incl. caja de herramientas**  
Página 105



**Juego de llaves de carraca aisladas de 3/8" de 21 unid. incl. caja de herramientas**  
Página 105



**Juego de llaves planas de una boca aisladas de 6 -32 mm de 21 unid. incl. caja de herramientas**  
Página 106



Para aplicaciones en la mecánica

**Juego de herramientas para mecánicos en surtido, de 34 unid., incl. funda para herramientas**  
Página 111



**Juego de herramientas para mecánicos con destornilladores, alicates de corte diagonal, alicates universales, de 7 unid. incl. bolsa**  
Página 111



Para aplicaciones en la electrónica

**Juego de herramientas ESD con alicates, destornilladores, pinzas, de 10 unid. incl. funda para herramientas**







n° pdo.	€/unid.
44128	1 1772,68

**Atornillado / agarrotado**

- 

Juego de herramientas slimVario® electric en surtido de 32 uds., incl. bolsa funcional (43465)  
 Bit slimBit electric Ranurado 2.0 mm x 75 mm (43115) / 3.5 mm x 75 mm (41159) / 5.5 mm x 75 mm (34581) / 6.5 mm x 75 mm (34582) / Bit slimBit electric Phillips PH0 x 75 mm (43116) / PH1 x 75 mm (34583) / PH2 x 75 mm (34584) / Bit slimBit electric PlusMinus/Pozidriv SL/PZ1 x 75 mm (34589) / SL/PZ2 x 75 mm (34590) / Bit slimBit electric Pozidriv PZ1 x 75 mm (34585) / PZ2 x 75 mm (34586) / Bit slimBit electric hexagonal 3.0 mm x 75 mm (37147) / 4.0 mm x 75 mm (37225) / 5.0 mm x 75 mm (37226) / Bit slimBit electric TORX® T10 x 75 mm (35507) / T15 x 75 mm (35508) / T20 x 75 mm (35509) / T25 x 75 mm (36071) / Inserto de llave de vaso aislado de hexágono exterior de 1/4" 5.0 mm (43089) / 5.5 mm (43090) / 6.0 mm (43091) / 7.0 mm (43092) / 8.0 mm (43093) / 10.0 mm (43095) / 11.0 mm (43096) / 13.0 mm (43098) / Adaptador slimVario® electric para llaves de vaso de 1/4" 6.0 mm (43139) / Prolongación slimVario® electric para slimBits 6.0 mm (43292) / Destornillador con portabits SoftFinish® slimVario® electric / Destornillador de precisión PicoFinish® slimVario® electric / Destornillador con portabits SoftFinish® electric slimVario Stubby / bolsa funcional
- 

Juego de bits XLSelector, bits en Y de 25 mm Phillips, Pozidriv, TORX®, de 32 unid. de 1/4" C6,3 (41832)  
 1 x Y-Bit 25 mm Phillips 1/4" PH1 / 4 x Y-Bit 25 mm Phillips 1/4" PH2 / 1 x Y-Bit 25 mm Phillips 1/4" PH3 / 2 x Y-Bit 25 mm Pozidriv 1/4" PZ1 / 4 x Y-Bit 25 mm Pozidriv 1/4" PZ2 / 2 x Y-Bit 25 mm Pozidriv 1/4" PZ3 / 2 x Y-Bit 25 mm TORX® 1/4" T10 / 3 x Y-Bit 25 mm TORX® 1/4" T15 / 3 x Y-Bit 25 mm TORX® 1/4" T20 / 3 x Y-Bit 25 mm TORX® 1/4" T25 / 3 x Y-Bit 25 mm TORX® 1/4" T30 / 2 x Y-Bit 25 mm TORX® 1/4" T40 / 1 x Portabits magnético 58 mm de 1/4" / 1 x XLSelector
- 

Llave universal con doble articulación con cabeza triangular, cabeza cuadrada y paletón doble 7-9- 5 - 8- 3 - 5 (44001)
- 

Juego de llaves Allen en soporte ErgoStar Cabeza esférica hexagonal MagicRing®, de 10 unid., en colores luminosos (41979)  
 1.5 mm / 2.0 mm / 2.5 mm / 3.0 mm / 4.0 mm / 5.0 mm / 6.0 mm / 8.0 mm / 10.0 mm / Soporte ErgoStar
- 

Destornillador SoftFinish® Ranurado con varilla hexagonal continua y plancha de acero maciza 12.0 mm x 200 mm (03231)
- 

Destornillador SoftFinish® electric slimFix Ranurado 3.5 mm x 100 mm (35446) / 5.5 mm x 125 mm (35391) / 6.5 mm x 150 mm (35392)
- 

Destornillador SoftFinish® electric slimFix Phillips PH1 x 80 mm (35393) / PH2 x 100 mm (35394)
- 

Destornillador SoftFinish® electric slimFix PlusMinus/Pozidriv SL/PZ1 x 80 mm (36329) / SL/PZ2 x 100 mm (36330)

**Transportar / sujetar**

- 

Tenazas llave Classic 250 mm, 10" (40923)
- 

Alicates de boca semi-redonda Professional electric con filo de corte, con forma recta 200 mm, 8" (26727)

**Desaislar / pelar / crimpar**

- 

Herramienta pelacable automática hasta 16 mm² en blíster 200 mm, 8" (42062)
- 

Crimpadora automática para extremos de cables, con presión hexagonal 210 mm, 0.08 - 16 (41246)
- 

Crimpadoras para terminales de cables y contactos aislados 220 mm, 0.5 - 6 (33841)
- 

Alicates de instalación TriCut Professional electric 170 mm, 7" (38552)
- 

Herramienta pelacable con cuchilla de arrastre autogirable para cables redondos 4 - 28, 165 mm (44618)

**Cortar a medida / cortar**

- 

Alicates para corte de cables Professional electric con resorte de apertura conectable y desconectable 180 mm, 7" (43660)
- 

Alicates de corte diagonal de alto rendimiento BiCut® Professional con DynamicJoint® conmutables 200 mm, 8" (38191)
- 

Alicates de corte diagonal Professional electric con DynamicJoint® 160 mm, 6 1/2" (43335)
- 

Sierra de arco electrico 280 mm (43125)

**Iluminar/Marcar/Medir/Comprobar**

- 

Comprobador de tensión con detector de voltaje, sin contacto, unipolar, 12 - 1.000 V CA incl. 2 pilas AAA 150 mm (43797)
- 

Linterna con LED, láser y luz UV en blíster incl. 3 pilas AAA 100 - 310 lm (41286)
- 

Metro plegable para electricista Longlife 2 m métrico, de 10 eslabones 15 mm (42068)
- 

Nivel de burbuja de aire para electricistas de 40 cm 400 mm (42074)

**Golpeo / cincelado**

- 

Martillo de electricista con cabeza del martillo de 300 g, en blíster 283 mm (42071)
- 

Juego de destornilladores-perforadores de agujeros para espigas SoftFinish® con espigas con varilla redonda de 6 mm, en blíster, de 5 unid. (41289)  
 1 x Destornillador-perforador de agujeros para espigas / 2 x Pasador de 30 mm / 2 x Pasador de 40 mm

**Otros**

- 

Abrebotellas SoftFinish® Perfecto para el taller y la cocina. (04703)

**Almacenamiento**

- 

Caja de herramientas XXL III vacía (44129)



n° pdo.	€/unid.
40523	1 1082,42

**Atornillado / agarrotado**

	Destornillador SoftFinish® electric con llave de vaso hexagonal 5.5 mm x 125 mm (00856) / 7.0 mm x 125 mm (00858) / 8.0 mm x 125 mm (00859) / 10.0 mm x 125 mm (00861)
	Destornillador SoftFinish® electric slimFix Ranurado 3.5 mm x 100 mm (35446) / 4.0 mm x 100 mm (35390) / 5.5 mm x 125 mm (35391) / 6.5 mm x 150 mm (35392)
	Destornillador SoftFinish® electric slimFix PlusMinus/Phillips SL/PH1 x 80 mm (35502) / SL/PH2 x 100 mm (35503)
	Destornillador SoftFinish® electric slimFix PlusMinus/Pozidriv SL/PZ1 x 80 mm (36329) / SL/PZ2 x 100 mm (36330)
	Destornillador SoftFinish® electric slimFix Phillips PH1 x 80 mm (35393) / PH2 x 100 mm (35394)
	Destornillador SoftFinish® electric slimFix Pozidriv PZ1 x 80 mm (35395) / PZ2 x 100 mm (35396)
	Destornillador SoftFinish® Ranurado con varilla hexagonal continua y plancha de acero maciza 12.0 mm x 200 mm (03231) / 7.0 mm-9- 5 - 8- 3 - 5 (36114)
	Destornillador con cargador LiftUp electric Phillips, PlusMinus/Pozidriv, ranurado con 6 slimBits (38611) 1 x 3.0 mm / 1 x 4.0 mm / 1 x 5.5 mm / 1 x PH1 / 1 x PH2 / 1 x SL/PZ2
	Juego de llaves Allen en soporte Compact con cabeza esférica hexagonal, de 10 unid., en cromado mate (01418) 1.5 mm / 2.0 mm / 2.5 mm / 3.0 mm / 4.0 mm / 5.0 mm / 6.0 mm / 8.0 mm / 10.0 mm / Soporte Compact
	Juego de bits XLSelector Standard de 25 mm en surtido, de 32 unid. de 1/4" C6,3 (29417) 1 x 4.5 mm / 1 x 5.5 mm / 1 x 6.5 mm / 2 x PH1 / 4 x PH2 / 1 x PH3 / 2 x PZ1 / 5 x PZ2 / 1 x PZ3 / 2 x T10 / 2 x T15 / 2 x T20 / 3 x T25 / 2 x T30 / 1 x T40 / 1 x Portabits magnético 58 mm de 1/4" / 1 x XLSelector

**Cortar a medida / cortar**

	Alicates de corte diagonal de alto rendimiento BiCut® Professional con DynamicJoint® conmutables 200 mm, 8" (38191)
	Alicates de corte diagonal para mecánicos de precisión Classic con resorte de apertura sin chaflán 125 mm, 5" (36189)
	Alicates de corte diagonal Professional electric con DynamicJoint® 180 mm, 7" (43340)

**Transportar / sujetar**

	Alicates para fontanería Professional electric con ajuste del pulsador 250 mm (37450)
	Alicates de boca semi-redonda Professional electric con filo de corte, con forma curvada, aprox. 40° 200 mm, 8" (26729)
	Alicates universales Professional electric con DynamicJoint® y OptiGrip con filo de corte extralargo 180 mm, 7" (26708)
	Alicates de boca semi-redonda Professional electric con filo de corte, con forma recta 200 mm, 8" (26727)

**Desaislar / pelar / crimpar**

	Alicates de instalación TriCut Professional electric 170 mm, 7" (38552)
	Herramienta pelacable automática hasta 6 mm² 190 mm, 7 1/2" (44617)
	Herramienta pelacable con cuchilla de arrastre autogirable para cables redondos 4 - 28, 165 mm (44618)
	Crimpadoras para extremos de cables 220 mm, 0.14 - 16 (33844)

**Iluminar/Marcar/Medir/Comprobar**

	Comprobador de tensión con detector de voltaje sin contacto, unipolar, 90 - 1.000 V CA incl. 2 pilas AAA 150 mm (43798)
	Comprobador de tensión SoftFinish® unipolar, para 110 - 250 voltios ranurado, transparente, con clip de conexión 3.0 mm (34745)
	Metro plegable Longlife® de 2 m métrico, de 10 eslabones 15 mm (27057)
	Nivel de burbuja del armario de control 20 cm (36859)

**Almacenamiento**

	caja de herramientas
--	----------------------



en surtido, de 31 unid. incl. bolsa

9300040

n° pdo.



€/unid.

43879

1

471,68

**Atornillado / agarrotado**

- ⊖ Destornillador SoftFinish® electric slimFix Ranurado 3.5 mm x 100 mm (35446) / 5.5 mm x 125 mm (35391)
- ⊕ Destornillador SoftFinish® electric slimFix Phillips PH1 x 80 mm (35393) / PH2 x 100 mm (35394)
- ⊕ Destornillador SoftFinish® electric slimFix Pozidriv PZ1 x 80 mm (35395) / PZ2 x 100 mm (35396)
- ⊖ Destornillador de precisión PicoFinish® Ranurado 1.5 mm x 40 mm (42384) / 2.0 mm x 40 mm (42388) / 2.5 mm x 50 mm (42391) / 3.0 mm x 50 mm (42394)
- ⊕ Destornillador de precisión PicoFinish® Phillips PH00 x 40 mm (42402) / PH0 x 50 mm (42401)
- ⊖ Llave para armarios de distribución en forma de cruz 7.0 mm- 9- 5 - 8- 3 - 5 (36114)
- Juego de llaves Allen en soporte Compact con cabeza esférica hexagonal, de 10 unid., en cromado mate (01418)  
1.5 mm / 2.0 mm / 2.5 mm / 3.0 mm / 4.0 mm / 5.0 mm / 6.0 mm / 8.0 mm / 10.0 mm / Soporte Compact

**Cortar a medida / cortar**

- ✂ Alicates de corte diagonal Professional electric con DynamicJoint® 160 mm, 6 1/2" (43335)
- ✂ Tenazas de puntas Electronic con cabeza corta estrecha con forma recta 135 mm, 5 1/3" (26801)
- ✂ Alicates de corte diagonal Electronic con cabeza puntiaguda ancha y muelle de sujeción de cable sin chaflán 130 mm, 5 1/8" (26825)

**Transportar / sujetar**

- Alicates de boca semi-redonda Professional electric con filo de corte, con forma recta 200 mm, 8" (26727)

**Desaislar / pelar / crimpar**

- Herramienta pelacable automática hasta 6 mm<sup>2</sup> 190 mm, 7 1/2" (44617)
- Herramienta pelacable con cuchilla de arrastre autogirable para cables redondos 4 - 28, 165 mm (44618)

**Iluminar/Marcar/Medir/Comprobar**

- ⊖ Comprobador de tensión SoftFinish® unipolar, para 110 - 250 voltios ranurado, transparente, con clip de conexión 3.0 mm (34745)

**Almacenamiento**

- Kit de herramientas



<b>vacía</b>	7209NRW
n° pdo.	€/unid.
43474	31,93



en surtido de 32 uds., incl. bolsa funcional 7209NK2002

n° pdo.	€/unid.
43465	324,74

⊖	Bit slimBit electric Ranurado 2.0 mm x 75 mm (43115) / 3.5 mm x 75 mm (41159) / 5.5 mm x 75 mm (34581) / 6.5 mm x 75 mm (34582)
⊕	Bit slimBit electric Phillips PH0 x 75 mm (43116) / PH1 x 75 mm (34583) / PH2 x 75 mm (34584)
⊕	Bit slimBit electric PlusMinus/Pozidriv SL/PZ1 x 75 mm (34589) / SL/PZ2 x 75 mm (34590)
⊕	Bit slimBit electric Pozidriv PZ1 x 75 mm (34585) / PZ2 x 75 mm (34586)
●	Bit slimBit electric hexagonal 3.0 mm x 75 mm (37147) / 4.0 mm x 75 mm (37225) / 5.0 mm x 75 mm (37226)
⊗	Bit slimBit electric TORX® T10 x 75 mm (35507) / T15 x 75 mm (35508) / T20 x 75 mm (35509) / T25 x 75 mm (36071)
○	Inserto de llave de vaso aislado de hexágono exterior de 1/4" 5.0 mm (43089) / 5.5 mm (43090) / 6.0 mm (43091) / 7.0 mm (43092) / 8.0 mm (43093) / 10.0 mm (43095) / 11.0 mm (43096) / 13.0 mm (43098)
	Adaptador slimVario® electric para llaves de vaso de 1/4" 6.0 mm (43139)
	Prolongación slimVario® electric para slimBits 6.0 mm (43292)
	Destornillador con portabits SoftFinish® slimVario® electric
	Destornillador de precisión PicoFinish® slimVario® electric
	Destornillador con portabits SoftFinish® electric slimVario Stubby
	bolsa funcional

Fabricado de acuerdo con IEC 60900.

## CUADRO INFORMATIVO: Herramientas homologadas según VDE



Las herramientas homologadas según VDE de Wiha se someten a procedimientos de control de seguridad estrictos.

Todas las herramientas con el distintivo especial han sido probadas a 10.000 V CA y están, por tanto, autorizadas para operar a 1.000 V CA y a 1.500 V CC.

Para todos los trabajos en la cercanía o con piezas sometidas a tensión deberá utilizar las medidas de protección que correspondan a cada trabajo:

- equipos de protección individual aislantes
- dispositivos de protección aislantes
- herramientas aisladas

Antes del comienzo de los trabajos en componentes activos de equipos eléctricos y medios de producción sometidos a tensión, deberá asegurarse de que no haya tensión y durante la realización de dichos trabajos.

Esto es así si se cumplen las cinco reglas de seguridad:

- Desconectar
- Asegurar que no haya reconexión
- Asegurarse de que no haya tensión
- Conectar a tierra y poner en cortocircuito
- Recubrir o aislar los componentes cercanos sometidos a tensión

Homologadas por el instituto de control y certificación VDE y comprobadas individualmente según la norma internacional IEC 60900:2012.

Juego de herramientas para electricistas

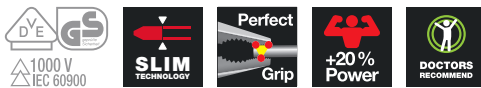

en surtido, de 33 unid., incl. funda para herramientas

9300035

n° pdo.	🏠	€/unid.
41241	1	252,64

**Atornillado / agarrotado**

- ⊖ Destornillador SoftFinish® electric slimFix Ranurado 3.5 mm x 100 mm (35446) / 5.5 mm x 125 mm (35391)
- ⊕ Destornillador SoftFinish® electric slimFix Phillips PH1 x 80 mm (35393) / PH2 x 100 mm (35394)
- ⊖ ⊕ ⊕ ⊕ Destornillador con cargador magnético en surtido con 8 bits, de 1/4" (32901)  
1 x 6.5 mm / 1 x PH1 / 1 x PH2 / 1 x PH3 / 1 x PZ2 / 1 x T15 / 1 x T20 / 1 x T25
- ⊕ ⊕ ⊕ Juego de bits FlipSelector Standard de 25 mm Phillips, Pozidriv, TORX®, de 14 unid. de 1/4" C6,3 (39040)  
2 x PH2 / 1 x PZ1 / 2 x PZ2 / 1 x PZ3 / 1 x T10 / 1 x T15 / 1 x T20 / 1 x T25 / 1 x T30 / 1 x T40 / 1 x Portabits magnético 58 mm de 1/4" / 1 x FlipSelector

**Cortar a medida / cortar**

- ✂ Alicates de corte diagonal Professional electric con DynamicJoint® 160 mm, 6 1/2" (43335)

**Transportar / sujetar**

- ⊖ Alicates universales Professional electric con DynamicJoint® y OptiGrip con filo de corte extralargo 180 mm, 7" (26708)

**Desaislar / pelar / crimpar**

- ⊖ Herramienta pelacable automática hasta 6 mm<sup>2</sup> 190 mm, 7 1/2" (44617)

**Iluminar/Marcar/Medir/Comprobar**

- ⊖ Comprobador de tensión SoftFinish® unipolar, para 110 - 250 voltios ranurado, transparente, con clip de conexión 3.0 mm (34745)
- ⊖ Metro plegable Longlife® de 2 m métrico, de 10 eslabones 15 mm (27057)

**Almacenamiento**

- ⊖ Kit de herramientas

Juego de herramientas para electricistas



en surtido, de 13 unid., incl. funda para herramientas

9300025

n° pdo.	🏠	€/unid.
36389	1	265,71

- ⊖ Destornillador SoftFinish® electric slimFix Ranurado 3.5 mm x 100 mm (35446) / 4.5 mm x 125 mm (35501) / 5.5 mm x 125 mm (35391)
- ⊕ Destornillador SoftFinish® electric slimFix Pozidriv PZ1 x 80 mm (35395) / PZ2 x 100 mm (35396)
- ⊖ Alicates para corte de cables Professional electric con resorte de apertura conectable y desconectable 210 mm, 8 1/4" (43662)
- ⊖ Alicates de boca semi-redonda Professional electric con filo de corte, con forma recta 200 mm, 8" (26727)
- ✂ Alicates de corte diagonal de fuerza Professional electric con DynamicJoint® con resorte de apertura conectable y desconectable 180 mm, 7" (41274)
- ⊖ Herramienta pelacable automática hasta 6 mm<sup>2</sup> 190 mm, 7 1/2" (44617)
- ⊖ Herramienta pelacable con cuchilla de arrastre autogirable para cables redondos 4 - 28, 165 mm (44618)
- ⊖ Comprobador de tensión SoftFinish® unipolar, para 110 - 250 voltios ranurado, transparente, con clip de conexión 3.0 mm (34745)
- ⊖ Metro plegable LongLife® Plus de 2 m métrico, de 10 eslabones 15 mm (27059)
- ⊖ Kit de herramientas



con destornilladores, alicates de corte diagonal de fuerza, de 8 unid., incl. funda para herramientas

9300031

n° pdo.	📦	€/unid.
38020	1	102,21

⊖	Destornillador SoftFinish® electric slimFix Ranurado 3.5 mm x 100 mm (35446) / 4.0 mm x 100 mm (35390) / 5.5 mm x 125 mm (35391)
⊕	Destornillador SoftFinish® electric slimFix Phillips PH2 x 100 mm (35394)
⊕	Destornillador SoftFinish® electric slimFix Pozidriv PZ2 x 100 mm (35396)
⊕	Destornillador SoftFinish® electric slimFix PlusMinus/ Pozidriv SL/PZ2 x 100 mm (36330)
⌘	Alicates de corte diagonal de fuerza Professional electric con DynamicJoint® con resorte de apertura conectable y desconectable 160 mm, 6 1/2" (40921)
	Kit de herramientas



con destornilladores, alicates de corte diagonal, de 7 unid., incl. funda para herramientas

9300018

n° pdo.	📦	€/unid.
33969	1	70,19

⊖	Destornillador SoftFinish® electric Ranurado 3.5 mm x 100 mm (00822) / 4.5 mm x 125 mm (00824) / 5.5 mm x 125 mm (00826)
⊕	Destornillador SoftFinish® electric Phillips PH1 x 80 mm (00847) / PH2 x 100 mm (00848)
⌘	Alicates de corte diagonal Professional electric con DynamicJoint® 160 mm, 6 1/2" (43335)
	Kit de herramientas

### CUADRO INFORMATIVO: DynamicJoint®



#### Wiha DynamicJoint® – La nueva dimensión de fuerza y duración

- Innovador: Construcción articulada única.
- Efectivo: Una menor pérdida de la fuerza se traduce en una menor fuerza necesaria para el corte.
- Durabilidad: Rendimiento óptimo incluso tras miles de cortes

Juego de herramientas para electricistas



con destornilladores, alicates de boca semi-redonda, alicates de corte diagonal, de 6 unid., incl. funda para herramientas

Z99000206

n° pdo.	Icono	€/unid.
26755	1	88,63
⊖	Destornillador SoftFinish® electric Ranurado 3.5 mm x 100 mm (00822) / 5.5 mm x 125 mm (00826)	
⊕	Destornillador SoftFinish® electric Phillips PH2 x 100 mm (00848)	
●	Alicates de boca semi-redonda Professional electric con filo de corte, con forma recta 200 mm, 8" (26727)	
⚡	Alicates de corte diagonal Professional electric con DynamicJoint® 160 mm, 6 1/2" (43335)	
	Kit de herramientas	

CUADRO INFORMATIVO: slimTECHNOLOGY



Wiha SoftFinish electric slimFix

- Accesibilidad sin obstáculos.
- Varillas hasta un 33 % más delgadas gracias al aislamiento integrado.
- Herramienta de accionamiento para grapas elásticas (geometría de accionamiento perfilada en forma de cuña).

Juego de herramientas para electricistas



en surtido, 18 unid. incl. bolsa para cinturón

930050005

n° pdo.	Icono	€/unid.
44574	1	289,18
⚡	Alicates de instalación TriCut Professional electric 170 mm, 7" (38552)	
●	Alicates de boca semi-redonda Professional electric con filo de corte, con forma recta 200 mm, 8" (26727)	
⚡	Alicates de corte diagonal Professional electric con DynamicJoint® 140 mm, 5 1/2" (43326)	
	Metro plegable para electricista Longlife 2 m métrico, de 10 eslabones 15 mm (42068)	
	Linterna con LED, láser y luz UV en blíster incl. 3 pilas AAA 100 - 310 lm (41286)	
⊖	Destornillador de precisión PicoFinish® electric Ranurado 1.5 mm x 50 mm (42374) / 2.5 mm x 65 mm (42376) / 3.5 mm x 100 mm (35446) / 4.0 mm x 100 mm (35390) / 5.5 mm x 125 mm (35391)	
⊕	Destornillador de precisión PicoFinish® electric Phillips PH00 x 50 mm (42379) / PH0 x 65 mm (42378)	
⊕	Destornillador SoftFinish® electric slimFix Pozidriv PZ1 x 80 mm (35395)	
⊕	Destornillador SoftFinish® electric slimFix PlusMinus/ Pozidriv SL/PZ2 x 100 mm (36330)	
⊕	Destornillador SoftFinish® electric slimFix TORX® T10 x 100 mm (36536)	
⊖	Comprobador de tensión SoftFinish® unipolar, para 110 - 250 voltios ranurado, transparente, con clip de conexión 3.0 mm (34745)	
	Cinta métrica 5 m	
	Bolsa de cinturón de herramientas	



**Juego de llaves de carraca aisladas de 1/2"**



**de 21 unid. incl. caja de herramientas**

7208NK2001

n° pdo.		€/unid.
43024	1	504,16

Adaptador para mango corredizo aislado para llaves de vaso (43063)

Llave de carraca aislada para llaves de vaso conmutables 1/2" (43053)

Prolongación aislada Adaptador cuadrado de 1/2" para insertos de llaves de vaso aislados 250 mm (43056) / 125 mm (43055)

Inserto de llave de vaso aislado de hexágono exterior de 1/2" 10.0 mm (43077) / 11.0 mm (43078) / 12.0 mm (43079) / 13.0 mm (43080) / 14.0 mm (43081) / 17.0 mm (43082) / 19.0 mm (43083) / 22.0 mm (43084) / 24.0 mm (43085) / 27.0 mm (43086) / 32.0 mm (43087)

Inserto de llave de vaso aislado de hexágono exterior de 1/2" 4.0 mm (43100) / 5.0 mm (43101) / 6.0 mm (43102) / 8.0 mm (43103) / 10.0 mm (43104)

caja de herramientas

Fabricados según EN/IEC 60900.  
DIN EN IEC 60900

**Juego de llaves de carraca aisladas de 3/8"**



**de 21 unid. incl. caja de herramientas**

7207NK2001

n° pdo.		€/unid.
43023	1	460,13

Adaptador para mango corredizo aislado para llaves de vaso (43062)

Llave de carraca aislada para llaves de vaso conmutables 3/8" (43052)

Prolongación aislada Adaptador cuadrado de 3/8" para insertos de llaves de vaso aislados 125 mm (43057) / 250 mm (43058)

Inserto de llave de vaso aislado de hexágono exterior de 3/8" 8.0 mm (43065) / 10.0 mm (43066) / 11.0 mm (43067) / 12.0 mm (43068) / 13.0 mm (43069) / 14.0 mm (43070) / 16.0 mm (43071) / 17.0 mm (43072) / 18.0 mm (43073) / 19.0 mm (43074) / 21.0 mm (43075) / 22.0 mm (43076)

Inserto de llave de vaso aislado de hexágono exterior de 3/8" 4.0 mm (43105) / 5.0 mm (43106) / 6.0 mm (43107) / 8.0 mm (43108)

caja de herramientas

DIN EN IEC 60900

**Juego de llaves de carraca aisladas de 1/4"**



**21 uds. caja incluida**

7209NK2001

n° pdo.		€/unid.
43025	1	417,10

Llave de carraca aislada para llaves de vaso Conmutable a 1/4" (43054)

Prolongación aislada Adaptador cuadrado de 1/4" para insertos de llaves de vaso aislados 75 mm (43059) / 150 mm (43060)

○ Inserto de llave de vaso aislado de hexágono exterior de 1/4" 4.0 mm (43088) / 5.0 mm (43089) / 5.5 mm (43090) / 6.0 mm (43091) / 7.0 mm (43092) / 8.0 mm (43093) / 9.0 mm (43094) / 10.0 mm (43095) / 11.0 mm (43096) / 12.0 mm (43097) / 13.0 mm (43098) / 14.0 mm (43099)

● Inserto de llave de vaso aislado Hexágono interior de 1/4" 3.0 mm (43109) / 4.0 mm (43110) / 5.0 mm (43111) / 6.0 mm (43112) / 8.0 mm (43113)

caja de herramientas

IEC 60900

**Juego de llaves planas de una boca aisladas de 6 -32 mm**



**de 21 unid. incl. caja de herramientas**

5590NT20

n° pdo.		€/unid.
43022	1	515,17

○ Llave plana de una boca, aislada 6.0 mm, 90 mm (43026) / 7.0 mm, 90 mm (43027) / 8.0 mm, 100 mm (43028) / 9.0 mm, 100 mm (43029) / 10.0 mm, 110 mm (43030) / 11.0 mm, 110 mm (43031) / 12.0 mm, 130 mm (43032) / 13.0 mm, 135 mm (43033) / 14.0 mm, 145 mm (43034) / 15.0 mm, 150 mm (43035) / 16.0 mm, 160 mm (43036) / 17.0 mm, 160 mm (43037) / 18.0 mm, 175 mm (43038) / 19.0 mm, 175 mm (43039) / 22.0 mm, 195 mm (43040) / 24.0 mm, 225 mm (43041) / 27.0 mm, 250 mm (43042) / 30.0 mm, 290 mm (43043) / 32.0 mm, 310 mm (43044)

○ Llave de una boca con rodillo y cremallera electric ajustable de manera variable de 0-30 mm 250 mm (43061)

caja de herramientas

DIN EN IEC 60900

Juego de insertos de llave de vaso de 1/4"  
TorqueVario®-S electric



Juego de destornilladores e insertos de llave de vaso de 1/4" slimVario® electric



en surtido, de 11 unid., incl. adaptadores y bolsa plegable

7209NK2003

n° pdo.	Icono	€/unid.
43466	1	175,03
		Adaptador slimVario® electric para llaves de vaso de 1/4" 6.0 mm (43139)
	○	Adaptador TorqueVario®-S electric para llaves de vaso de 1/4" (43128)
	○	Inserto de llave de vaso aislado de hexágono exterior de 1/4" 5.0 mm (43089) / 5.5 mm (43090) / 6.0 mm (43091) / 7.0 mm (43092) / 8.0 mm (43093) / 10.0 mm (43095) / 11.0 mm (43096) / 13.0 mm (43098)
		Bolsa plegable

en surtido, de 14 unid., incl. bolsa plegable

7209NK2004

n° pdo.	Icono	€/unid.
43467	1	197,05
		Destornillador con mango SoftFinish® electric
		Prolongación slimVario® electric para slimBits 6.0 mm (43292)
		Adaptador slimVario® electric para llaves de vaso de 1/4" 6.0 mm (43139)
	⊖	Bit slimBit electric Ranurado 3.5 mm x 75 mm (41159) / 5.5 mm x 75 mm (34581)
	○	Inserto de llave de vaso aislado de hexágono exterior de 1/4" 5.0 mm (43089) / 5.5 mm (43090) / 6.0 mm (43091) / 7.0 mm (43092) / 8.0 mm (43093) / 10.0 mm (43095) / 11.0 mm (43096) / 13.0 mm (43098)
		Bolsa plegable

Fabricado de acuerdo con IEC 60900.

### Llave plana de una boca, aislada



5590N

n° pdo.	mm	mm	€/unid.
43026	6.0	90	17,61
43027	7.0	90	17,61
43028	8.0	100	17,61
43029	9.0	100	17,61
43030	10.0	110	17,61
43031	11.0	110	17,61
43032	12.0	130	19,81
43033	13.0	135	19,81
43034	14.0	145	19,81
43035	15.0	150	19,81
43036	16.0	160	22,02
43037	17.0	160	22,02
43038	18.0	175	22,02
43039	19.0	175	22,02
43040	22.0	195	26,42
43041	24.0	225	28,62
43042	27.0	250	30,82
43043	30.0	290	33,02
43044	32.0	310	37,43

### Llave de una boca con rodillo y cremallera electric



5590NA

n° pdo.	mm	mm	€/unid.
43061	0 - 30	250	55,04

### Adaptador para mango corredizo aislado para llaves de vaso



24618T

n° pdo.	mm	mm	€/unid.
43063	1/2"	200	38,53
43062	3/8"	200	33,02

### Llave de carraca aislada para llaves de vaso



#### conmutables

7207NRW

n° pdo.	mm	mm	€/unid.
43053	1/2"	250	115,58
43052	3/8"	200	104,58
43054	1/4"	145	91,38

**Inserto de llave de vaso aislado**



**de hexágono exterior de 1/2"**

7208NS

n° pdo.	Ø	mm	🏠	€/unid.
43077	10.0	55	1	17,61
43078	11.0	55	1	17,61
43079	12.0	55	1	17,61
43080	13.0	55	1	17,61
43081	14.0	55	1	17,61
43082	17.0	55	1	19,81
43083	19.0	55	1	19,81
43084	22.0	55	1	24,22
43085	24.0	55	1	24,22
43086	27.0	55	1	24,22
43087	32.0	55	1	24,22

**Inserto de llave de vaso aislado**



**de hexágono exterior de 1/4"**

7209NS

n° pdo.	Ø	mm	🏠	€/unid.
43088	4.0	42	1	15,42
43089	5.0	42	1	15,42
43090	5.5	42	1	15,42
43091	6.0	42	1	15,42
43092	7.0	42	1	15,42
43093	8.0	42	1	15,42
43094	9.0	42	1	15,42
43095	10.0	42	1	15,42
43096	11.0	42	1	16,51
43097	12.0	42	1	16,51
43098	13.0	42	1	16,51
43099	14.0	42	1	16,51

**Inserto de llave de vaso aislado**



**de hexágono exterior de 3/8"**

7207NS

n° pdo.	Ø	mm	🏠	€/unid.
43065	8.0	45	1	16,51
43066	10.0	45	1	16,51
43067	11.0	45	1	16,51
43068	12.0	45	1	16,51
43069	13.0	45	1	16,51
43070	14.0	45	1	16,51
43071	16.0	45	1	18,72
43072	17.0	45	1	18,72
43073	18.0	45	1	18,72
43074	19.0	47	1	18,72
43075	21.0	47	1	22,02
43076	22.0	47	1	22,02

**Prolongación aislada**



**Adaptador cuadrado de 1/2" para insertos de llaves de vaso aislados**

7208NEX

n° pdo.	Ø	mm	🏠	€/unid.
43055	1/2"	125	1	33,02
43056	1/2"	250	1	38,53

**Adaptador cuadrado de 3/8" para insertos de llaves de vaso aislados**

7207NEX

n° pdo.	Ø	mm	🏠	€/unid.
43057	3/8"	125	1	33,02
43058	3/8"	250	1	38,53

**Adaptador cuadrado de 1/4" para insertos de llaves de vaso aislados**

7209NEX



n° pdo.	Ø	mm	🏠	€/unid.
43059	1/4"	75	1	27,52
43060	1/4"	150	1	32,25

Inserto de llave de vaso aislado



de hexágono exterior de 3/8"

7207NHS



n° pdo.				€/unid.
43105	4.0	75	1	27,52
43106	5.0	75	1	27,52
43107	6.0	75	1	27,52
43108	8.0	75	1	27,52

Inserto de llave de vaso aislado



Hexágono interior de 1/4"

7209NHS



n° pdo.				€/unid.
43113	8.0	65	1	25,80
43112	6.0	65	1	25,80
43111	5.0	65	1	25,80
43110	4.0	65	1	25,80
43109	3.0	65	1	25,80

Inserto de llave de vaso aislado



de hexágono exterior de 1/2"

7208NHS

n° pdo.				€/unid.
43100	4.0	120	1	28,62
43101	5.0	120	1	28,62
43102	6.0	120	1	28,62
43103	8.0	120	1	28,62
43104	10.0	120	1	28,62

Juego de herramientas para mecánicos



en surtido, de 34 unid., incl. funda para herramientas

9300026

n° pdo.	📦	€/unid.
36390	1	263,42

- ⊖ Destornillador SoftFinish® ranurado con varilla redonda y escala en mm grabada con láser 4.0 mm x 100 mm (36085) / 5.5 mm x 125 mm (35397)
- ⊕ Destornillador SoftFinish® Phillips con varilla redonda y escala en mm grabada con láser PH1 x 80 mm (36072) / PH2 x 100 mm (35398)
- Destornillador con mango corredizo y dos portabits Comfort grip magnéticos de 1/4" 150 mm (26179)
- ✂ Alicates universales Professional con DynamicJoint® y OptiGrip con filo de corte extralargo 200 mm, 8" (26713)
- ✂ Alicates de corte diagonal de fuerza Professional con DynamicJoint® con resorte de apertura conectable y desconectable 180 mm, 7" (41273)
- ✂ Alicates para fontanería Classic con botón 250 mm (26765)
- Metro plegable Longlife® de 2 m métrico, de 10 eslabones 15 mm (27057)

**Atornillado / agarrotado**

- ⊕ ⊕ ⊕ Juego de bits FlipSelector Standard de 25 mm Phillips, Pozidriv, TORX®, de 14 unid. de 1/4" C6,3 (39040)  
2 x PH2 / 1 x PZ1 / 2 x PZ2 / 1 x PZ3 / 1 x T10 / 1 x T15 / 1 x T20 / 1 x T25 / 1 x T30 / 1 x T40 / 1 x Portabits magnético 58 mm de 1/4" / 1 x FlipSelector
- Juego de llaves Allen en soporte ErgoStar con cabeza esférica hexagonal MagicRing®, de 10 unid., en cromado mate (37351)  
1.5 mm / 2.0 mm / 2.5 mm / 3.0 mm / 4.0 mm / 5.0 mm / 6.0 mm / 8.0 mm / 10.0 mm / Soporte ErgoStar

**Almacenamiento**

Kit de herramientas

Juego de herramientas para mecánicos



en surtido, de 33 unid., incl. funda para herramientas

9300024

n° pdo.	📦	€/unid.
36388	1	138,18

- ⊖ Destornillador SoftFinish® ranurado para tornillos situados a mayor profundidad 3.0 mm x 100 mm (00687) / 5.5 mm x 125 mm (00698)
- ⊕ Destornillador SoftFinish® Phillips con varilla redonda PH1 x 80 mm (00756) / PH2 x 100 mm (00759)
- Destornillador con mango corredizo y portabits magnético de 1/4" 150 mm (01481)
- ✂ Alicates de corte diagonal Classic con DynamicJoint® 160 mm, 6 1/2" (43332)
- ✂ Alicates para fontanería Classic deslizados 250 mm (26761)
- Metro plegable Longlife® de 2 m métrico, de 10 eslabones 15 mm (27057)

**Atornillado / agarrotado**

- ⊕ ⊕ ⊕ Juego de bits FlipSelector Standard de 25 mm Phillips, Pozidriv, TORX®, de 14 unid. de 1/4" C6,3 (39040)  
2 x PH2 / 1 x PZ1 / 2 x PZ2 / 1 x PZ3 / 1 x T10 / 1 x T15 / 1 x T20 / 1 x T25 / 1 x T30 / 1 x T40 / 1 x Portabits magnético 58 mm de 1/4" / 1 x FlipSelector
- Juego de llaves Allen en soporte Compact hexagonales, de 10 unid., en niquelado brillante (01222)  
1.5 mm / 2.0 mm / 2.5 mm / 3.0 mm / 4.0 mm / 5.0 mm / 6.0 mm / 8.0 mm / 10.0 mm / Soporte Compact

**Almacenamiento**

Kit de herramientas

Juego de herramientas para mecánicos



con destornilladores, alicates de corte diagonal, alicates universales, de 7 unid. incl. bolsa

9300019

n° pdo. €/unid.  
33970 1 62,49

⊖ Destornillador SoftFinish® ranurado con varilla redonda para tornillos situados a mayor profundidad 3.5 mm x 100 mm (00691) / 4.5 mm x 125 mm (00697) / 6.5 mm x 150 mm (00703)

⊕ Destornillador SoftFinish® Phillips con varilla redonda PH1 x 80 mm (00756) / PH2 x 100 mm (00759)

Alicates universales Professional con DynamicJoint® y OptiGrip con filo de corte extralargo 180 mm, 7" (26707)

Kit de herramientas

Juego de herramientas para mecánicos



con destornilladores, alicates de corte diagonal, de 7 unid., incl. funda para herramientas

9300020

n° pdo. €/unid.  
33971 1 62,49

⊖ Destornillador SoftFinish® ranurado con varilla redonda para tornillos situados a mayor profundidad 3.5 mm x 100 mm (00691) / 4.5 mm x 125 mm (00697) / 6.5 mm x 150 mm (00703)

⊕ Destornillador SoftFinish® Phillips con varilla redonda PH1 x 80 mm (00756) / PH2 x 100 mm (00759)

⚡ Alicates de corte diagonal Professional con DynamicJoint® 160 mm, 6 1/2" (43334)

Kit de herramientas

CUADRO INFORMATIVO:  
OptiGrip

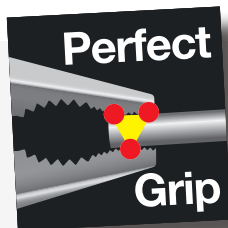

**Wiha OptiGrip: sujeción óptima gracias a la nueva forma de las superficies de agarre**

- Sujeción segura: El »apoyo en tres puntos« evita la torsión o el movimiento de la pieza de trabajo.
- Eficaz: Sujeción óptima hasta con una abertura de boca grande y al mismo tiempo una aplicación de fuerza notablemente menor.
- Gran variedad: Ahora en alicates universales y alicates universales de fuerza estándar Wiha.



Juego de herramientas para mecánicos



con destornilladores, alicates de corte diagonal, alicates universales, de 6 unid. incl. carpeta de herramientas

Z99000602

n° pdo.	📦	€/unid.
30824	1	66,23

- ⊖ Destornillador SoftFinish® ranurado con varilla redonda para tornillos situados a mayor profundidad 3.5 mm x 100 mm (00691) / 5.5 mm x 125 mm (00698)
- ⊕ Destornillador SoftFinish® Phillips con varilla redonda PH2 x 100 mm (00759)
- ⚡ Alicates universales Industrial con DynamicJoint® y OptiGrip con filo de corte extralargo 180 mm, 7" (30826)
- ⚡ Alicates de corte diagonal Industrial con DynamicJoint® 160 mm, 6 1/2" (43333)
- Kit de herramientas

Juego de herramientas ESD



con alicates, destornilladores, pinzas, de 10 unid. incl. funda para herramientas

9300041

n° pdo.	📦	€/unid.
43994	1	193,34

- ⊖ Alicates de boca semi-redonda Professional ESD con forma recta 120 mm, 4 3/4" (26799)
- ⚡ Alicates de corte diagonal Professional ESD con cabeza puntiaguda ancha sin chaflán 115 mm, 4 1/2" (26821)
- Pinzas universales Professional ESD de tipo AA 130 mm (32318)
- ⊖ Destornillador de precisión PicoFinish® ESD Spår 2.0 mm x 40 mm (43670) / 2.5 mm x 50 mm (43671)
- ⊕ Destornillador de precisión PicoFinish® ESD Phillips PH0 x 50 mm (43677) / PH00 x 40 mm (43676)
- ⊕ Destornillador de precisión PicoFinish® ESD TORX® T5 x 40 mm (43698) / T6 x 40 mm (43699)
- Kit de herramientas

CUADRO INFORMATIVO:  
**Herramientas con derivación electrostática ESD**

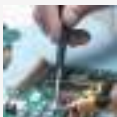

Los componentes electrónicos sensibles pueden resultar dañados de forma irreparable incluso con la menor tensión.

- Las herramientas disipadoras de Wiha derivan la energía eléctrica de forma controlada y segura.
- Las herramientas ESD cumplen la norma ESD IEC 61340-5-1.
- Los mangos de las herramientas ESD tienen una resistencia superficial de 10<sup>6</sup> - 10<sup>9</sup> ohmios.

**Bolsa para cinturón**



**para el destornillador eléctrico speedE®**

7209NEX

n° pdo.		€/unid.
44367	1	20,96

**Juego de bits de montaje**



**20 unid., en bolsa enrollable**

79187T05

n° pdo.		€/unid.
44576	1	72,03

- ⊗ Bit Professional TORX® de 1/4" E6,3 T15 (32307) / T20 (32308) / T25 (32309) / T30 (33923) / T40 (33928)
- ⊕ Bit Professional Phillips de 1/4" E6,3 PH0 (32105) / PH1 (33703) / PH2 (33704)
- ⊗ Bit Professional PlusMinus/Pozidriv de 1/4" E6,3 SL/PZ1 (32494) / SL/PZ2 (32496)
- ⊖ Bit Professional ranurado de 1/4" E6,3 3.5 mm (01792) / 4.0 mm (01794) / 5.5 mm (01796)
- Bit Professional hexagonal de 1/4" E6,3 4.0 mm (04195) / 5.0 mm (04196) / 6.0 mm (04197)
- Portabits magnético, fijación mediante anillo de retención de 1/4" 100 mm (36092) / 150 mm (34306)
- Destornillador con portabits SoftFinish® magnético de 1/4" 112 mm (32160)
- Bolsa enrollable Nylon

Herramienta pelacables y crimpadora, juego de 5 unid.

Herramienta pelacables y crimpadora, juego de 5 unid.



con extremos de cable 500 ud. codificación por colores 1 (FR) en L-Boxx Mini

93001001

n° pdo.		€/unid.
43985	1	395,87

Desaislar / pelar / crimpar

- Crimpadora automática para extremos de cables, con presión hexagonal 210 mm, 0.08 - 16 (41246)
- Herramienta pelacable automática hasta 16 mm<sup>2</sup> en blíster 200 mm, 8" (42062)
- Extremo del cable con cuello de plástico, juego 0,5 - 2,5 mm<sup>2</sup> 400 ud. codificación por colores 1 (FR) en bote distribuidor (43900)  
50 x 0.5 mm<sup>2</sup> / 100 x 0.75 mm<sup>2</sup> / 100 x 1 mm<sup>2</sup> / 100 x 1.5 mm<sup>2</sup> / 50 x 2.5 mm<sup>2</sup>
- Extremo del cable con cuello de plástico, juego 4 - 16 mm<sup>2</sup> 100 ud. codificación por colores 1 (FR) en bote distribuidor (43899)  
50 x 4 mm<sup>2</sup> / 20 x 6 mm<sup>2</sup> / 20 x 10 mm<sup>2</sup> / 10 x 16 mm<sup>2</sup>

Almacenamiento

L-Boxx Mini

con extremos de cable 500 ud. codificación por colores DIN en L-Boxx Mini

93001003

n° pdo.		€/unid.
43987	1	395,87

Desaislar / pelar / crimpar

- Crimpadora automática para extremos de cables, con presión hexagonal
- Herramienta pelacable automática hasta 16 mm<sup>2</sup> en blíster
- Extremo del cable con cuello de plástico, juego 0,5 - 2,5 mm<sup>2</sup> 400 ud. codificación por colores DIN en bote distribuidor (43904)  
50 x 0.5 mm<sup>2</sup> / 100 x 0.75 mm<sup>2</sup> / 100 x 1 mm<sup>2</sup> / 100 x 1.5 mm<sup>2</sup> / 50 x 2.5 mm<sup>2</sup>
- Extremo del cable con cuello de plástico, juego 4 - 16 mm<sup>2</sup> 100 ud. codificación por colores DIN en bote distribuidor (43903)  
50 x 4 mm<sup>2</sup> / 20 x 6 mm<sup>2</sup> / 20 x 10 mm<sup>2</sup> / 10 x 16 mm<sup>2</sup>







Almacenamiento

L-Boxx Mini









**con elementos de unión 2600 ud. codificación por colores 1 (FR) en caja surtida**

93001011

n° pdo.		€/unid.
43982		1 636,05
	Crimpadora automática para extremos de cables, con presión hexagonal Herramienta pelacable automática hasta 16 mm <sup>2</sup> en blíster	
	Crimpadoras para terminales de cables y contactos aislados	
	0.5 mm <sup>2</sup> / 0.75 mm <sup>2</sup> / 1 mm <sup>2</sup> / 1.5 mm <sup>2</sup> / 2.5 mm <sup>2</sup> / 4 mm <sup>2</sup> / 6 mm <sup>2</sup> / 10 mm <sup>2</sup> / 16 mm <sup>2</sup>	
	0.5 - 1 mm <sup>2</sup> ; M4 / 0.5 - 1 mm <sup>2</sup> ; M5 / 1.5 - 2.5 mm <sup>2</sup> ; M5 / 1.5 - 2.5 mm <sup>2</sup> ; M6 / 4 - 6 mm <sup>2</sup> ; M6 / 4 - 6 mm <sup>2</sup> ; M8	
	0.5 - 1 mm <sup>2</sup> / 1.5 - 2.5 mm <sup>2</sup> / 4 - 6 mm <sup>2</sup>	
	0.5 - 1 mm <sup>2</sup> / 1.5 - 2.5 mm <sup>2</sup>	
	0.5 - 1 mm <sup>2</sup> / 1.5 - 2.5 mm <sup>2</sup>	
	Caja	

**con elementos de unión 2600 ud. codificación por colores DIN en caja surtida**

93001013

n° pdo.		€/unid.
43984		1 636,05
	Crimpadora automática para extremos de cables, con presión hexagonal Herramienta pelacable automática hasta 16 mm <sup>2</sup> en blíster	
	Crimpadoras para terminales de cables y contactos aislados	
	0.5 mm <sup>2</sup> / 0.75 mm <sup>2</sup> / 1 mm <sup>2</sup> / 1.5 mm <sup>2</sup> / 2.5 mm <sup>2</sup> / 4 mm <sup>2</sup> / 6 mm <sup>2</sup> / 10 mm <sup>2</sup> / 16 mm <sup>2</sup>	
	0.5 - 1 mm <sup>2</sup> / 0.5 - 1 mm <sup>2</sup> / 1.5 - 2.5 mm <sup>2</sup> / 1.5 - 2.5 mm <sup>2</sup> / 4 - 6 mm <sup>2</sup> / 4 - 6 mm <sup>2</sup>	
	0.5 - 1 mm <sup>2</sup> / 1.5 - 2.5 mm <sup>2</sup> / 4 - 6 mm <sup>2</sup>	
	0.5 - 1 mm <sup>2</sup> / 1.5 - 2.5 mm <sup>2</sup>	
	0.5 - 1 mm <sup>2</sup> / 1.5 - 2.5 mm <sup>2</sup>	
	Caja	



**de 16 unid., para caja para herramientas  
surtidas, con elementos de fijación**

93001911R

n° pdo.		€/unid.
43995	1	23,27

8 x Inserto 55 A9-1 para caja para herramientas surtidas  
pequeña

8 x Inserto 55 A9-1 para caja para herramientas surtidas  
grande

Recambio: Cajas de inserción para la caja de surtido de elementos de conexión 43982 y 43984



## **Electro**

### **Seguridad para los profesionales.**

Wiha ha revolucionado el mercado de los destornilladores con el destornillador eléctrico speedE®. Ya se trate de un atornillado sensible, tornillos largos o una cantidad enorme de tornillos: El destornillador eléctrico permite que los profesionales puedan realizar el trabajo más rápido. En particular la función de protección del material hace que el speedE® sea único: Con 0,4 Nm se detiene automáticamente la asistencia eléctrica y permite al usuario apretar el tornillo de forma manual y con la máxima sensibilidad. Como producto certificado de acuerdo con la normas VDE, el speedE® ofrece a los electricistas una protección completa para realizar sus trabajos diarios.

La linterna giratoria de Wiha está dotada de un láser integrado, con luz UV y con una luz LED en dos niveles de iluminación.

Con el Torque QuickCheck, Wiha lanza al mercado el primer comprobador rápido móvil para la comprobación regular de herramientas dinamométricas, garantizando así un trabajo seguro y preciso.

Atornillado

**Destornillador eléctrico speedE® II electric** surtido de 7 uds., con slimBits, baterías y cargador USB en L-Boxx Mini  
Página 120



**Juego básico de destornillador eléctrico speedE® I electric** surtido de 4 uds., incl. slimBit, batería y cargador USB  
Página 120



**Juego de destornilladores eléctricos speedE® electric Industrial TORX®**, de 5 unid. con bit, batería y cargador USB  
Página 120



Iluminar/ Marcar

**Linterna con LED, láser y luz UV** en blíster incl. 3 pilas AAA  
Página 124



Comprobar

**Comprobador de tensión con detector de voltaje protegido contra explosión, sin contacto, unipolar 12 – 1.000 V CA se incluyen 2 pilas AAA**  
Página 125



**Juego de comprobador de par de apriete Torque QuickCheck4** unid. con varillas adaptadoras, pilas y caja  
Página 126



**Comprobador de tensión y paso, 12-1.000 V CA, CAT IV** incl. 2 pilas AAA  
Página 125



## Destornillador eléctrico speedE® II electric



surtido de 7 uds., con slimBits, baterías y cargador USB en L-Boxx Mini

591T101

n° pdo.		€/unid.
44318	1	181,68
+	SL/PZ2 x 75	
-	3.5 mm x 75 mm	
	Mango del destornillador eléctrico speedE®	
	Cargador para batería tipo 18500 Li-Ion con USB	
	Juego de baterías 18500 Li-Ion 2 piezas en una caja	

## Juego básico de destornillador eléctrico speedE® I electric



surtido de 4 uds., incl. slimBit, batería y cargador USB

590T401

n° pdo.		€/unid.
44351	1	149,43
+	SL/PZ1 x 75 mm	
	Mango del destornillador eléctrico speedE®	
	Cargador para baterías tipo 18500 de iones de litio con USB y euroconector (41915) enchufe de alimentación speedE EU	
	Juego de baterías 18500 de iones de litio 2 ud. en caja (41914)	

### INFOBOX: speedE® II de Wiha



#### Destornillador eléctrico speedE® II electric

- El triple de rápido que manualmente.
- Made in Germany.
- Trabajo seguro hasta 1000 V CA.
- Apriete manual hasta 12 Nm.
- Luz anular LED potente.
- Batería estándar reemplazable.
- Protección de las manos y los músculos al trabajar.
- 100 % compatible con el sistema slimBit de Wiha.

### INFOBOX: speedE® de Wiha



#### Destornillador eléctrico speedE®

- La asistencia eléctrica de atornillado duplica la velocidad de trabajo.
- Gracias a la función de protección del material integrada, la asistencia eléctrica se detiene al alcanzar 0,4 Nm.
- El apriete de tornillos manual final se puede realizar a mano con sensibilidad.
- Recomendado por médicos y terapeutas.
- Los slimBits han sido probados a 10.000 V CA y ha sido autorizada para 1.000 V CA.



Juego de bits slimBit electric



Juego de bits Power slimBit electric



ranurados, Phillips, Pozidriv, de 7 unid., incl. caja de slimBits

SB2831B903

n° pdo.	📦	€/unid.
43160	1	52,77
⊖	2.0 mm x 75 mm / 2.5 mm x 75 mm	
⊕	PH0 x 75 mm / PH1 x 75 mm	
⊕	PZ0 x 75 mm / PZ1 x 75 mm	
	Caja de slimBits	

Probados en conformidad con la norma IEC 60900.

en surtido, de 7 uds., incl. caja de slimBits

SB2831B904

n° pdo.	📦	€/unid.
44366	1	52,77
⊖	2.5 mm x 75 mm	
⊕	PH1 x 75 mm	
⊕	PZ1 x 75 mm	
⊕	SL/PZ1 x 75 mm	
⊕	T9 x 75 mm / T10 x 75 mm	
	Caja de slimBits	

Probados en conformidad con la norma IEC 60900.

ranurados, hexagonales, de 7 uds., incl. caja de slimBits

SB2831PB901

n° pdo.	📦	€/unid.
44107	1	52,77
⊖	6,5 mm x 75 mm	
●	2,5 x 75 mm / 3 x 75 mm / 4 x 75 mm / 5 x 75 mm / 6 x 75 mm	
	Caja de slimBits	

Probados en conformidad con la norma IEC 60900.

en surtido, de 7 uds., incl. caja de slimBits

SB2831PB900

n° pdo.	📦	€/unid.
44106	1	52,77
⊖	5,5 mm x 75 mm	
⊕	PH2 x 75 mm	
⊕	SL/PZ2 x 75 mm	
⊕	T15 x 75 mm / T20 x 75 mm / T25 x 75 mm	
	Caja de slimBits	

Probados en conformidad con la norma IEC 60900.

Cargador para baterías tipo 18500 de iones de litio



con USB y euroconector

5992

n° pdo.



€/unid.

41915 1

38,53

Cargador para baterías tipo 18500 de iones de litio



con USB y conector británico

5992

n° pdo.



€/unid.

42766 1

38,53

Enchufe de red



UE

599006

n° pdo.



€/unid.

44363 1 19,35

enchufe de alimentación speedE EU

Enchufe de red



Reino Unido

599007

n° pdo.



€/unid.

44364 1 19,35

enchufe de alimentación speedE UK

Juego de baterías 18500 de iones de litio



2 ud. en caja

599001

n° pdo.



€/unid.

41914 6 33,02



**TORX®, de 5 unid. con bit, batería y cargador USB**

590T601

n° pdo.		€/unid.
43631	Mango del destornillador eléctrico speedE®	1 149,43
	Portabits con bit T20 de 50 mm	
	18500 batería de iones de litio	
	Cargador USB para batería tipo 18500 Li-Ion	

INFOBOX:  
**Wiha speedE®  
Industrial**



**Destornillador eléctrico speedE®**

- Recomendado por médicos y terapeutas.
- Atornillado eléctrico con función de protección para evitar que se produzcan daños en el material (máx. 0,4 Nm).
- Fijación manual con la máxima sensibilidad.
- Trabajar 2 veces más rápido gracias al proceso en 3 fases.



en blíster incl. 3 pilas AAA

24670

n° pdo.	LED		UV				€/unid.
41286	100 - 310 lm	Clase 2	390 - 400 nm	2 pilas AAA	-	5	63,99

INFOBOX:  
**Linterna con LED, láser y luz UV**  
**Linterna con LED, láser y luz UV**

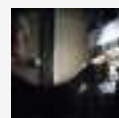

Útil para el trabajo universal con láser integrado, luz UV y luz LED.

- Opción de posicionamiento óptima y orientación de la luz variable gracias a la base magnética y a la cabeza giratoria.
- Para el montaje en el techo de lámparas se puede transmitir la posición directamente desde el centro de la mesa al techo.
- La luz UV integrada es ideal para localizar las herramientas en colores luminosos de Wiha y para realizar inspecciones técnicas.

Comprobador de tensión con detector de voltaje, sin contacto, unipolar, 12 – 1.000 V CA



incl. 2 pilas AAA

25513

n° pdo.					€/unid.
43797	2x 1,5 V AAA	28.5	150	10	31,16

Comprobador de tensión con detector de voltaje sin contacto, unipolar, 90 – 1.000 V CA



incl. 2 pilas AAA

25514

n° pdo.					€/unid.
43798	2x 1,5 V AAA	28.5	150	10	17,73

Comprobador de tensión con detector de voltaje protegido contra explosión, sin contacto, unipolar 12 – 1.000 V CA



se incluyen 2 pilas AAA

25513

n° pdo.					€/unid.
44309	2x 1,5 V AAA	28.5	150	10	47,19

Comprobador de tensión y paso, 12-1.000 V CA, CAT IV



incl. 2 pilas AAA

25515

n° pdo.					€/pc.
44319	2 pilas AAA	28.5	240	10	134,38

## INFOBOX: Detector de voltaje

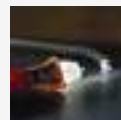

### Espiga de comprobación para tensiones alternas.

- La espiga de comprobación detecta tensiones alternas a partir de 230 V CA
- El LED rojo de gran intensidad luminosa indica la tensión alterna
- No es necesario que el usuario asegure el flujo de corriente
- Cumple la norma de seguridad IEC 61010-1: Categoría de medición CAT III 1.000 V
- Detecta la tensión alterna en un entorno de 4 mm
- Certificación CE



4 unid. con varillas adaptadoras, pilas y caja

2909

n° pdo.	Nm	FA%	SB	€/unid.
42086	2.8	2	-	166,83

### INFOBOX: Torque QuickCheck



#### Torque QuickCheck de Wiha

- Los destornilladores dinamométricos de Wiha se pueden comprobar de forma rápida y sencilla en cuanto a la precisión del valor dinamométrico ajustado antes de cada uso para el trabajo.
- La comprobación periódica de la herramienta garantiza el trabajo seguro y preciso
- Manejo sencillo para el usuario, resultados de comprobación claros que pueden leerse fácilmente en el semáforo de LED
- Gracias a la forma compacta y manejable se convierte en el compañero ideal para el uso móvil
- Adecuado para todos los destornilladores dinamométricos iTorque® y Torque Vario® -S cuyo rango dinamométrico incluya 2,8 Nm.





## **Destornilladores**

### **Tenemos los conocimientos técnicos bajo control.**

En comparación con muchas herramientas convencionales, los destornilladores de Wiha están adaptados de manera óptima a los requisitos de los usuarios. Gracias al innovador concepto de tamaños de mango SoftFinish, ofrecemos cuatro tamaños y longitudes de mango adaptadas de manera óptima a los respectivos casos de atornillado y tareas de trabajo que garantizan un trabajo que protege su salud. Por SoftFinish, Wiha ha sido premiado como primer y único fabricante de herramientas manuales en todo el mundo con el prestigioso sello de calidad de AGR - aceptado en la comunidad de profesionales médicos y recomendado oficialmente por médicos y terapeutas. Los destornilladores de Wiha con SoftFinish están disponibles para aplicaciones en seco, para aplicaciones en húmedo y con aceite y como destornilladores aislados y con homologación VDE para trabajos en el sector de las piezas conductoras de tensión.

Por sus alicates Inomic y el concepto de tamaños de mango para destornilladores, Wiha es el primer fabricante de herramientas manuales a nivel mundial con la certificación AGR, aceptado en la comunidad de profesionales médicos y recomendado oficialmente por médicos y terapeutas.



Para aplicaciones en la electricidad

**Juego de destornilladores y bits slimVario® ranurados, Phillips, Pozidriv, de 10 unid., incl. bolsa plegable**  
Página 130



**Juego de destornilladores SoftFinish® electric slimFix en surtido de 12 unid.**  
Página 131

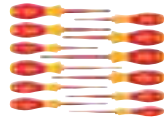

**Juego de destornilladores SoftFinish® electric slimFix ranurados, Phillips, de 6 unid**  
Página 132

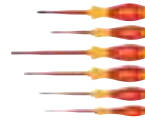

**Juego de destornilladores con portabits electric slimVario® Stubby de 4 unid con slimBits**  
Página 134



**Juego de bits slimBit electric ranurados, de 7 unid., incl. caja de slimBits**  
Página 136



**Destornillador SoftFinish® electric slimFix Ranurado**  
Página 140



**Destornillador de precisión PicoFinish® electric Ranurado**  
Página 141



**Destornillador de precisión PicoFinish® electric Ranurado**  
Página 142



Para aplicaciones en la mecánica

**Juego de destornilladores SoftFinish® en surtido de 12 unid.**  
Página 143

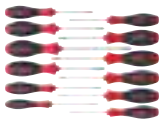

**Juego de destornilladores SoftFinish® ranurados, Phillips, de 6 unid**  
Página 143

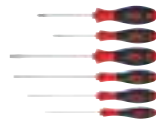

**Juego de destornilladores SoftFinish® ranurados, Phillips, de 6 unid., con varilla hexagonal continua y plancha de acero maciza**  
Página 145



**Juego de destornilladores de precisión PicoFinish® en surtido, de 8 unid., incl. pinzas para dispositivos iPhone®/ Apple®**  
Página 145

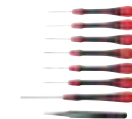

**Destornillador SoftFinish® ranurado con varilla redonda para tornillos situados a mayor profundidad**  
Página 147



**Destornillador SoftFinish® Ranurado con varilla hexagonal continua y plancha de acero maciza**  
Página 151



**Juego de destornilladores de precisión PicoFinish® ranurados, Phillips, de 7 unid.**  
Página 153



**Destornillador SoftFinish® ranurado con varilla redonda corta**  
Página 152



**Juego de destornilladores MicroFinish ranurado, Phillips, con varilla hexagonal continua y plancha de acero maciza, de 5 unid.**  
Página 156



**Destornillador MicroFinish TORX® con varilla redonda**  
Página 156



**Destornillador MicroFinish Ranurado con varilla hexagonal continua y plancha de acero maciza**  
Página 158



**Juego de extractores de tornillos hexagonal, de 17 unid., con broca espiral, incl. caja**  
Página 160



Para aplicaciones en la electrónica

**Juego de destornilladores SoftFinish® ESD ranurados, Phillips, de 5 unid.**  
Página 157

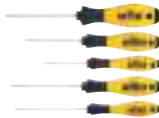

**Juego de destornilladores de precisión PicoFinish® ESD ranurados, Phillips, de 7 unid., incl. soporte**  
Página 158



**Destornillador SoftFinish® ESD Ranurado**  
Página 158



Juego de destornilladores y bits slimVario®



en surtido, de 19 unid., incl. bolsa plegable 2831T18

n° pdo.	€/unid.
41231	136,50

- 1 x Destornillador con portabits SoftFinish® electric slimVario
- 1 x Destornillador con portabits SoftFinish® electric slimVario para slimBits
- ⊖ 1 x 2.5 mm / 1 x 3.5 mm / 1 x 5.5 mm
- ⊕ 1 x PH1 / 1 x PH2
- ⊕ 1 x PZ1 / 1 x PZ2
- ⊕ 1 x SL/PZ1 / 1 x SL/PZ2
- ⊕ 1 x T9 / 1 x T10 / 1 x T15 / 1 x T20
- 1 x 3.0 mm / 1 x 4.0 mm / 1 x 5.0 mm
- 1 x Bolsa plegable

Fabricado de acuerdo con IEC 60900.

Juego de destornilladores y bits slimVario®



ranurados, Phillips, Pozidriv, de 10 unid., incl. bolsa plegable 2831T91

n° pdo.	€/unid.
41232	93,69

- 1 x Destornillador con portabits SoftFinish® electric slimVario
- 1 x Destornillador con portabits SoftFinish® electric slimVario para slimBits
- ⊖ 1 x 2.5 mm / 1 x 3.5 mm / 1 x 5.5 mm
- ⊕ 1 x PH1 / 1 x PH2
- ⊕ 1 x PZ1 / 1 x PZ2
- 1 x Bolsa plegable

Fabricado de acuerdo con IEC 60900.

ranurados, Pozidriv, PlusMinus/Pozidriv, de 10 unid., incl. bolsa plegable 2831T92

n° pdo.	€/unid.
41233	93,69

- 1 x Destornillador con portabits SoftFinish® electric slimVario
- 1 x Destornillador con portabits SoftFinish® electric slimVario para slimBits
- ⊖ 1 x 2.5 mm / 1 x 3.5 mm / 1 x 5.5 mm
- ⊕ 1 x PZ1 / 1 x PZ2
- ⊕ 1 x SL/PZ1 / 1 x SL/PZ2
- 1 x Bolsa plegable

Fabricado de acuerdo con IEC 60900.

CUADRO INFORMATIVO: slimTECHNOLOGY

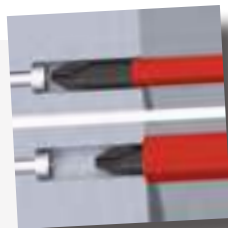

Wiha SoftFinish electric slimFix

- Accesibilidad sin obstáculos.
- Varillas hasta un 33 % más delgadas gracias al aislamiento integrado.
- Herramienta de accionamiento para grapas elásticas (geometría de accionamiento perfilada en forma de cuña).

**Juego de destornilladores SoftFinish® electric slimFix**

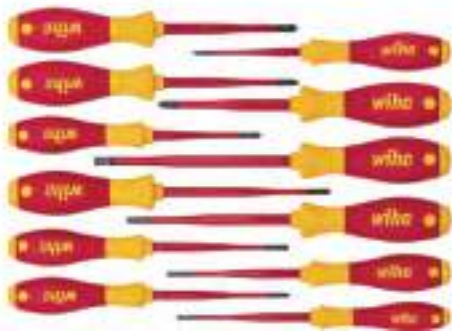

<b>en surtido de 12 unid.</b>		3201K12
n° pdo.		€/unid.
41003	1	144,37
	3.5 mm x 100 mm / 4.0 mm x 100 mm / 5.5 mm x 125 mm / 6.5 mm x 150 mm	
	PH1 x 80 mm / PH2 x 100 mm	
	PZ1 x 80 mm / PZ2 x 100 mm	
	SL/PZ2 x 100 mm	
	T15 x 100 mm / T20 x 100 mm / T25 x 125 mm	

Fabricado de acuerdo con IEC 60900.

**CUADRO INFORMATIVO:  
Concepto de tamaños de mango**



**Tamaños de mango SoftFinish® de Wiha**

- Cada mango de Wiha ofrece una relación entre el guiado, la velocidad y el par de apriete, adaptada de manera óptima a la tarea de atornillado.
- Giro rápido: consideración consecuente de las capacidades dinámicas de los dedos.
- Máxima transmisión de fuerzas: transmisión cómoda y sin pérdidas de la fuerza muscular, incluso para la aplicación de atornillado intensa.
- Las zonas de fuerza y de giro rápido (longitud) se integran con una intensidad diferente en los cuatro tamaños de mango.
- Los destornilladores SoftFinish de Wiha permiten trabajar protegiendo las manos y los músculos y por ello son recomendados por médicos y terapeutas de la asociación AGR.



**CUADRO INFORMATIVO:  
Herramientas homologadas según VDE**



Las herramientas homologadas según VDE de Wiha se someten a procedimientos de control de seguridad estrictos.

Todas las herramientas con el distintivo especial han sido probadas a 10.000 V CA y están, por tanto, autorizadas para operar a 1.000 V CA y a 1.500 V CC.

Para todos los trabajos en la cercanía o con piezas sometidas a tensión deberá utilizar las medidas de protección que correspondan a cada trabajo:

- equipos de protección individual aislantes
- dispositivos de protección aislantes
- herramientas aisladas

Antes del comienzo de los trabajos en componentes activos de equipos eléctricos y medios de producción sometidos a tensión, deberá asegurarse de que no haya tensión y durante la realización de dichos trabajos.

Esto es así si se cumplen las cinco reglas de seguridad:

- Desconectar
- Asegurar que no haya reconexión
- Asegurarse de que no haya tensión
- Conectar a tierra y poner en cortocircuito
- Recubrir o aislar los componentes cercanos sometidos a tensión

Homologadas por el instituto de control y certificación VDE y comprobadas individualmente según la norma internacional IEC 60900:2012.

**Juego de destornilladores SoftFinish® electric slimFix**



**ranurados, Phillips, de 6 unid**

3201K6

n° pdo.	🏠	€/unid.
35389	1	66,87

- ⊖ 3.5 mm x 100 mm / 4.0 mm x 100 mm / 5.5 mm x 125 mm / 6.5 mm x 150 mm
- ⊕ PH1 x 80 mm / PH2 x 100 mm

Fabricado de acuerdo con IEC 60900.

**ranurado, Phillips, PlusMinus/Pozidriv, de 6 unid.**

3201K601

n° pdo.	🏠	€/unid.
38362	1	67,75

- ⊖ 3.5 mm x 100 mm / 4.0 mm x 100 mm / 5.5 mm x 125 mm
- ⊕ PH1 x 80 mm / PH2 x 100 mm
- ⊕ SL/PZ2 x 100 mm

Fabricado de acuerdo con IEC 60900.

**ranurados, Pozidriv, de 6 unid**

3201ZK6

n° pdo.	🏠	€/unid.
36455	1	68,12

- ⊖ 3.5 mm x 100 mm / 4.0 mm x 100 mm / 5.5 mm x 125 mm / 6.5 mm x 150 mm
- ⊕ PZ1 x 80 mm / PZ2 x 100 mm

Fabricado de acuerdo con IEC 60900.

**TORX® Tamper Resistant (con taladro), de 6 unid.**

3251TRK6

n° pdo.	🏠	€/unid.
41245	1	83,52

- ⊕ T10H x 100 mm / T15H x 100 mm / T20H x 100 mm / T25H x 125 mm / T30H x 125 mm / T40H x 150 mm

Fabricado de acuerdo con IEC 60900.

**TORX®, de 6 unid.**

3251K6

n° pdo.	🏠	€/unid.
36558	1	70,44

- ⊕ T8 x 60 mm / T9 x 60 mm / T10 x 100 mm / T15 x 100 mm / T20 x 100 mm / T25 x 125 mm

Fabricado de acuerdo con IEC 60900. T8 + T9 sin versión slim.

Fabricado de acuerdo con IEC 60900.

**Juego de destornilladores SoftFinish® electric slimFix**



**ranurados, PlusMinus/Pozidriv, de 2 unid.**

SB3201S204

n° pdo.	🏠	€/unid.
36333	1	33,42

- ⊖ 3.5 mm x 100 mm

- ⊕ SL/PZ2 x 100 mm

Fabricado de acuerdo con IEC 60900.

**CUADRO INFORMATIVO:  
Perfil de combinación**



**PlusMinus.**

- El perfil especial PlusMinus/Pozidriv resulta idóneo para tornillos de terminal PlusMinus
- El perfil de combinación minimiza el deslizamiento del bit de la cabeza del tornillo y garantiza una transmisión del par más alta.

**Juego de destornilladores SoftFinish® electric**



**ranurados, Phillips, de 7 unid.**

320NK7

n° pdo.	🏠	€/unid.
00834	1	56,65
⊖	2.5 mm x 75 mm / 4.0 mm x 100 mm / 5.5 mm x 125 mm / 6.5 mm x 150 mm	
⊕	PH1 x 80 mm / PH2 x 100 mm	
⊖	Comprobador de tensión SoftFinish® unipolar, para 110 - 250 voltios ranurado, transparente, con clip de conexión	

Fabricado de acuerdo con IEC 60900.

**ranurados, Phillips, de 6 unid**

320NK6

n° pdo.	🏠	€/unid.
00833	1	54,44
⊖	3.0 mm x 100 mm / 4.0 mm x 100 mm / 5.5 mm x 125 mm / 6.5 mm x 150 mm	
⊕	PH1 x 80 mm / PH2 x 100 mm	

Fabricado de acuerdo con IEC 60900.

**ranurados, Pozidriv, de 6 unid**

320NZK6SO

n° pdo.	🏠	€/unid.
25477	1	53,81
⊖	2.5 mm x 75 mm / 3.5 mm x 100 mm / 4.5 mm x 125 mm / 5.5 mm x 125 mm	
⊕	PZ1 x 80 mm / PZ2 x 100 mm	

Fabricado de acuerdo con IEC 60900.

**Juego de destornilladores SoftFinish® electric**



**PlusMinus/Phillips de 2 unid.**

SB327S2

n° pdo.	🏠	€/unid.
32281	1	24,68
⊕	SL/PH1 x 80 mm / SL/PH2 x 100 mm	

Fabricado de acuerdo con IEC 60900.

**PlusMinus/Pozidriv, de 2 unid.**

SB328S2

n° pdo.	🏠	€/unid.
32282	1	26,97
⊕	SL/PZ1 x 80 mm / SL/PZ2 x 100 mm	

Fabricado de acuerdo con IEC 60900.

Juego de destornilladores SoftFinish® electric



con llave de vaso hexagonal, de 5 unid.

322K5

n° pdo.	€/unid.
29466	1 85,31

- 5.5 mm x 125 mm / 7.0 mm x 125 mm /
- 8.0 mm x 125 mm / 10.0 mm x 125 mm /
- 13.0 mm x 125 mm

Fabricado de acuerdo con IEC 60900.

Juego de destornillador de precisión PicoFinish® slimVario® electric



de 4 unid, con slimBits

SB28310401

n° pdo.	€/unid.
43167	5 47,63

- Destornillador de precisión PicoFinish® slimVario® electric
- ⊖ 2.0 mm
- ⊕ PH0
- ⊕ SL/PZ0

Fabricado de acuerdo con IEC 60900.

Juego de destornilladores con portabits electric slimVario®



SB28310101

n° pdo.	€/unid.
41230	1 47,63

- Destornillador con portabits SoftFinish® electric slimVario
- ⊖ 3.5 mm
- ⊕ PH2
- ⊕ SL/PZ2

Fabricado de acuerdo con IEC 60900.

Juego de destornilladores con portabits SoftFinish® slimVario® electric



de 4 unid, con slimBits

SB28310301

n° pdo.	€/unid.
43449	5 47,63

- Destornillador con portabits SoftFinish® electric slimVario para slimBits
- ⊖ 5.5 mm
- ⊕ SL/PZ1 x 75 mm / SL/PZ2 x 75 mm

Fabricado de acuerdo con IEC 60900.

Prolongación slimVario® electric



para slimBits		2831
n° pdo.		€/unid.
43292	6	18,71

Adaptador slimVario® electric



para llaves de vaso de 1/4"		2831		
n° pdo.		mm		€/unid.
43139	6.0	59	6	21,27

Destornillador con portabits SoftFinish® electric slimVario



para slimBits		2831						
n° pdo.								€/unid.
34577	6.0	30	50	160	13	5	5	30,42

Fabricado de acuerdo con IEC 60900.

Juego de destornilladores de precisión PicoFinish® electric



ranurados, Phillips, de 7 unid., incl. soporte		2270PK601
n° pdo.		€/unid.
42989	1	52,45
⊖	1 x 1.5 mm x 50 mm / 1 x 2.0 mm x 50 mm / 1 x 2.5 mm x 65 mm / 1 x 3.0 mm x 65 mm	
⊕	1 x PH00 x 50 mm / 1 x PH0 x 65 mm	
	1 x soporte	

CUADRO INFORMATIVO:  
PicoFinish electric



**Wiha PicoFinish electric: El destornillador de precisión con homologación VDE y GS.**

- La tapa giratoria de giro suave permite girar con rapidez.
- El símbolo del tipo de tornillo y el tamaño impresos facilitan el reconocimiento.

Juego de bits slimBit electric



**TORX®, TORX PLUS®, de 15 unid., incl. cajas de slimBits y clip**

SB2831B950

n° pdo.		€/unid.
43161	1	105,54
	1 x T6 / 1 x T7 / 1 x T8 / 1 x T9 / 1 x T10 / 1 x T15	
	1 x 6IP / 1 x 7IP / 1 x 8IP / 1 x 9IP / 1 x 10IP / 1 x 15IP	
	2 x Caja de slimBits	
	1 x Clip para el cinturón para caja de slimBits	

Probados en conformidad con la norma IEC 60900.

**ranurados, Phillips, Pozidriv, PlusMinus/Pozidriv, TORX®, de 15 unid., incl. cajas de slimBits y clip**

SB2831B951

n° pdo.		€/unid.
43162	1	105,54
	1 x 3.5 mm / 1 x 5.5 mm	
	1 x PH1 / 1 x PH2	
	1 x PZ1 / 1 x PZ2	
	1 x SL/PZ1 / 1 x SL/PZ2	
	1 x T10 / 1 x T15 / 1 x T20 / 1 x T25	
	2 x Caja de slimBits	
	1 x Clip para el cinturón para caja de slimBits	

Probados en conformidad con la norma IEC 60900.

Juego de bits slimBit electric



**ranurados, de 7 unid., incl. caja de slimBits**

SB2831B001

n° pdo.		€/unid.
43152	1	52,77
	1 x 2.0 mm / 1 x 2.5 mm / 1 x 3.5 mm / 1 x 4.0 mm / 1 x 5.5 mm / 1 x 6.5 mm	
	1 x Caja de slimBits	

Probados en conformidad con la norma IEC 60900.

**TORX®, de 7 unid., incl. caja de slimBits**

SB2831B501

n° pdo.		€/unid.
43153	1	52,77
	1 x T8 / 1 x T9 / 1 x T10 / 1 x T15 / 1 x T20 / 1 x T25	
	1 x Caja de slimBits	

Probados en conformidad con la norma IEC 60900.

**TORX®, de 7 unid., incl. caja de slimBits**

SB2831B502

n° pdo.		€/unid.
43154	1	52,77
	1 x T6 / 1 x T7 / 1 x T8 / 1 x T9 / 1 x T10 / 1 x T15	
	1 x Caja de slimBits	

Probados en conformidad con la norma IEC 60900.

**TORX PLUS®, de 7 unid., incl. caja de slimBits**

SB2831B601

n° pdo.		€/unid.
43155	1	52,77
	1 x 6IP / 1 x 7IP / 1 x 8IP / 1 x 9IP / 1 x 10IP / 1 x 15IP	
	1 x Caja de slimBits	

Probados en conformidad con la norma IEC 60900.

**hexagonales, de 7 unid., incl. caja de slimBits**

SB2831B801

n° pdo.		€/unid.
43156	1	52,77
	1 x 2.0 mm / 1 x 2.5 mm / 1 x 3.0 mm / 1 x 4.0 mm / 1 x 5.0 mm / 1 x 6.0 mm	
	1 x Caja de slimBits	

Probados en conformidad con la norma IEC 60900.



**ranurados, Pozidriv, de 7 unid., incl. caja de slimBits**

SB2831B900

n° pdo.		€/unid.
43157	1	52,77
⊖	1 x 2.5 mm / 1 x 3.5 mm / 1 x 5.5 mm / 1 x 6.5 mm	
⊕	1 x PZ1 / 1 x PZ2	
	1 x Caja de slimBits	

Probados en conformidad con la norma IEC 60900.

**ranurados, PlusMinus/Pozidriv, de 7 unid., incl. caja de slimBits**

SB2831B901

n° pdo.		€/unid.
43158	1	52,77
⊖	1 x 2.5 mm / 1 x 3.5 mm / 1 x 5.5 mm / 1 x 6.5 mm	
⊕	1 x SL/PZ1 / 1 x SL/PZ2	
	1 x Caja de slimBits	

Probados en conformidad con la norma IEC 60900.

**ranurados, Phillips, de 7 unid., incl. caja de slimBits**

SB2831B902

n° pdo.		€/unid.
43159	1	52,77
⊖	1 x 2.5 mm / 1 x 3.5 mm / 1 x 5.5 mm / 1 x 6.5 mm	
⊕	1 x PH1 / 1 x PH2	
	1 x Caja de slimBits	

Probados en conformidad con la norma IEC 60900.

**ranurados, Phillips, Pozidriv, de 7 unid., incl. caja de slimBits**

SB2831B903

n° pdo.		€/unid.
43160	1	52,77
⊖	1 x 2.0 mm / 1 x 2.5 mm	
⊕	1 x PH0 / 1 x PH1	
⊕	1 x PZ0 / 1 x PZ1	
	1 x Caja de slimBits	

Probados en conformidad con la norma IEC 60900.

**en surtido, de 7 uds., incl. caja de slimBits**

SB2831B904

n° pdo.		€/unid.
44366	1	52,77
⊖	1 x 2.5 mm	
⊕	1 x PH1	
⊕	1 x PZ1	
⊕	1 x SL/PZ1	
⊕	1 x T9 / 1 x T10	
	1 x Caja de slimBits	

Probados en conformidad con la norma IEC 60900.

**Juego de bits Power slimBit electric**



**en surtido, de 7 uds., incl. caja de slimBits**

SB2831PB900

n° pdo.		€/unid.
44106	1	52,77
⊖	1 x Bit Power slimBit eléctrico - Ranurado 5,5	
⊕	1 x Bit Power slimBit eléctrico - Phillips 2	
⊕	1 x Bit Power slimBit electric - SL/PZ2	
⊕	1 x Bit Power slimBit eléctrico - T15 / 1 x Bit Power slimBit eléctrico - T20 / 1 x Bit Power slimBit eléctrico - T25	
	1 x Caja de slimBits	

Probados en conformidad con la norma IEC 60900.

**ranurados, hexagonales, de 7 uds., incl. caja de slimBits**

SB2831PB901

n° pdo.		€/unid.
44107	1	52,77
⊖	1 x Bit Power slimBit eléctrico - Ranurado 6,5	
⊕	1 x Bit Power slimBit eléctrico - Hexagonal interior 2,5 / 1 x Bit Power slimBit eléctrico - Hexagonal interior 3 / 1 x Bit Power slimBit eléctrico - Hexagonal interior 4 / 1 x Bit Power slimBit eléctrico - Hexagonal interior 5 / 1 x Bit Power slimBit eléctrico - Hexagonal interior 6	
	1 x Caja de slimBits	

Probados en conformidad con la norma IEC 60900.

Bit slimBit electric



Ranurado

283110

n° pdo.		mm		max. Nm		€/unid.
43114	1.5•	75	0.4	0.2	5	8,79
43115	2.0•	75	0.4	0.4	5	8,79
34578	2.5•	75	0.4	0.4	5	8,79
34579	3.0•	75	0.5	0.6	5	8,79
41159	3.5	75	0.6	1.4	5	8,79
34580	4.0	75	0.8	2.5	5	8,79
34581	5.5	75	1.0	3.8	5	8,79
34582	6.5	75	1.2	5.5	5	8,79

•sin versión slim  
Fabricado de acuerdo con IEC 60900.

Ranurado con pivote

283110

n° pdo.		mm		max. Nm		€/unid.
44385	3.5	75	0.6	1.4	5	8,79

Phillips

283111

n° pdo.		mm	max. Nm		€/unid.
43116	PH0•	75	0.9	5	8,79
34583	PH1	75	3.8	5	8,79
34584	PH2	75	5.5	5	8,79

•no versión slim  
Fabricado de acuerdo con IEC 60900.

Pozidriv

283112

n° pdo.		mm	max. Nm		€/unid.
43117	PZ0•	75	0.9	5	8,79
34585	PZ1	75	3.8	5	8,79
34586	PZ2	75	5.5	5	8,79

•no versión slim  
Fabricado de acuerdo con IEC 60900.

PlusMinus/Phillips

283113

n° pdo.		mm	max. Nm		€/unid.
34587	SL/PH1	75	3.8	5	8,79
34588	SL/PH2	75	5.5	5	8,79

Fabricado de acuerdo con IEC 60900.

PlusMinus/Pozidriv

283114

n° pdo.		mm	max. Nm		€/unid.
34589	SL/PZ1	75	3.8	5	8,79
34590	SL/PZ2	75	5.5	5	8,79

Fabricado de acuerdo con IEC 60900.

TORX®

283115

n° pdo.		mm	max. Nm		€/unid.
43140	T5•	75	0.4	5	8,79
43141	T6•	75	0.6	5	8,79
43142	T7•	75	0.9	5	8,79
35506	T8•	75	1.3	5	8,79
41160	T9•	75	2.5	5	8,79
35507	T10•	75	3.8	5	8,79
35508	T15	75	5.0	5	8,79
35509	T20	75	5.5	5	8,79
36071	T25	75	5.5	5	8,79

•sin versión slim  
Fabricado de acuerdo con IEC 60900.

TORX PLUS®

283116

n° pdo.		mm	max. Nm		€/unid.
43143	5IP•	75	0.5	5	8,79
43144	6IP•	75	0.8	5	8,79
43145	7IP•	75	1.3	5	8,79
43146	8IP•	75	2.0	5	8,79
43147	9IP•	75	3.0	5	8,79
43148	10IP•	75	4.5	5	8,79
43149	15IP••	75	5.5	5	8,79
43150	20IP••	75	5.5	5	8,79
43151	25IP••	75	5.5	5	8,79

•sin versión slim  
••no versión slim  
Fabricado de acuerdo con IEC 60900.

hexagonal

283118

n° pdo.		mm	max. Nm		€/unid.
37222	1.5•	75	0.9	5	8,79
37223	2.0•	75	1.8	5	8,79
37224	2.5••	75	3.8	5	8,79
37147	3.0••	75	5.5	5	8,79
37225	4.0••	75	5.5	5	8,79
37226	5.0••	75	5.5	5	8,79
37227	6.0••	75	5.5	5	8,79

•sin versión slim  
••no versión slim  
Fabricado de acuerdo con IEC 60900.

cuadrado

283117

n° pdo.		mm	max. Nm		€/unid.	
35510	#1	2.3	75	5.5	5	8,79
35511	#2	2.8	75	5.5	5	8,79

Fabricado de acuerdo con IEC 60900.

Caja de slimBits



vacía 2 unid. con clip para cinturón

SB2831B992

n° pdo.		€/unid.
43164	1	16,51
2 x Caja de slimBits		
1 x Clip para el cinturón para caja de slimBits		

Caja de slimBits



ranurado, Phillips, PlusMinus/Pozidriv, de 10 unid., en caja L-Boxx Mini, con slimBits, pilas y cargador UE

2831

n° pdo.		€/unid.
43163	1	5,50

CUADRO INFORMATIVO:  
slimTECHNOLOGY



Wiha SoftFinish electric slimFix

- Accesibilidad sin obstáculos.
- Varillas hasta un 33 % más delgadas gracias al aislamiento integrado.
- Herramienta de accionamiento para grapas elásticas (geometría de accionamiento perfilada en forma de cuña).



**Ranurado**

3201

n° pdo.							€/unid.
35446	3.5	100	0.6	204	23	10	11,17
35390	4.0	100	0.8	211	30	10	13,29
35501	4.5	125	1.0	236	30	10	14,54
35391	5.5	125	1.0	243	36	10	16,07
35392	6.5	150	1.2	268	36	10	20,81

Fabricado de acuerdo con IEC 60900.

**Phillips**

3211

n° pdo.						€/unid.
35393	PH1	80	191	30	10	14,79
35394	PH2	100	218	36	10	19,94

Fabricado de acuerdo con IEC 60900.

**Pozidriv**

3241

n° pdo.						€/unid.
35395	PZ1	80	191	30	10	16,54
35396	PZ2	100	218	36	10	22,47

Fabricado de acuerdo con IEC 60900.

**PlusMinus/Phillips**

3271

n° pdo.						€/unid.
35502	SL/PH1	80	191	30	10	16,18
35503	SL/PH2	100	218	36	10	21,70

Fabricado de acuerdo con IEC 60900.

**PlusMinus/Pozidriv**

3281

n° pdo.						€/unid.
36329	SL/PZ1	80	191	30	10	17,69
36330	SL/PZ2	100	218	36	10	23,47

Fabricado de acuerdo con IEC 60900.

**TORX® Tamper Resistant (con taladro)**

3251TR

n° pdo.						€/unid.
41141	T10H	100	204	23	10	16,15
41142	T15H	100	211	30	10	16,57
41143	T20H	100	211	30	10	17,24
41144	T25H	125	243	36	10	17,80
41145	T27H	125	243	36	10	18,64
41146	T30H	125	243	36	10	19,60
41147	T40H	150	268	36	10	20,81

Fabricado de acuerdo con IEC 60900.

**TORX®**

3251

n° pdo.						€/unid.
36536	T10	100	204	23	10	14,67
36537	T15	100	211	30	10	15,06
36538	T20	100	211	30	10	15,68
36539	T25	125	243	36	10	16,18
36540	T27	125	243	36	10	16,93
36541	T30	125	243	36	10	17,81
36542	T40	150	268	36	10	18,93

Fabricado de acuerdo con IEC 60900.

**cuadrado**

3581

n° pdo.					€/unid.
35504	#1	2.3	211	10	19,82
35505	#2	2.8	243	10	22,71



**Ranurado**

320N

n° pdo.							€/unid.
00819	2.0	60	0.4	164	23	10	7,50
00820	2.5	75	0.4	179	23	10	7,39
00821	3.0	100	0.5	204	23	10	7,39
00822	3.5	100	0.6	204	23	10	7,64
00823	4.0	100	0.8	211	30	10	9,42
00824	4.5	125	1.0	236	30	10	10,59
00825	4.5	175	1.0	286	30	5	11,73
31863	4.5	200	1.0	311	30	5	11,85
00826	5.5	125	1.0	243	36	10	11,89
00827	5.5	175	1.0	293	36	5	13,21
00828	6.0	150	1.2	268	36	10	12,56
00829	6.5	150	1.2	268	36	10	13,55
00830	8.0	175	1.2	299	41	10	15,76
00831	8.0	175	1.6	299	41	10	15,97
00832	10.0	200	1.6	324	41	5	20,19

Fabricado de acuerdo con IEC 60900.

**Phillips**

321N

n° pdo.						€/unid.
00846	PH0	60	164	23	10	8,69
00847	PH1	80	191	30	10	10,41
00848	PH2	100	218	36	10	12,70
00849	PH3	150	268	41	10	15,76
00850	PH4	200	318	41	5	22,46

Fabricado de acuerdo con IEC 60900.

**Pozidriv**

324

n° pdo.						€/unid.
00877	PZ0	60	164	23	10	9,66
00878	PZ1	80	191	30	10	11,33
00879	PZ2	100	218	36	10	13,79
00880	PZ3	150	324	41	5	18,10

Fabricado de acuerdo con IEC 60900.

**PlusMinus/Phillips**

327

n° pdo.						€/unid.
30716	SL/PH1	80	191	30	10	11,45
30715	SL/PH2	100	218	36	10	14,17

Fabricado de acuerdo con IEC 60900.

**PlusMinus/Pozidriv**

328

n° pdo.						€/unid.
30700	SL/PZ1	80	191	30	10	12,56
30701	SL/PZ2	100	218	36	10	15,39

Fabricado de acuerdo con IEC 60900.

**TORX®**

325

n° pdo.						€/unid.
03760	T5	60	164	23	10	13,31
03761	T6	60	164	23	10	10,85
03762	T7	60	164	23	10	10,85
00881	T8	60	164	23	10	10,85
00882	T9	60	164	23	10	11,33

Fabricado de acuerdo con IEC 60900.

**hexagonal**

323N

n° pdo.						€/unid.
30361	2.5	75	179	23	10	10,59
30362	3.0	75	179	23	10	11,20
30363	4.0	75	186	30	10	12,70
30364	5.0	75	186	30	10	13,90
30365	6.0	100	218	36	10	15,15
30366	8.0	100	218	36	10	18,35

Fabricado de acuerdo con IEC 60900.

**cuadrado**

358N

n° pdo.						€/unid.	
32396	#1	2.3	100	211	30	10	13,79
32397	#2	2.8	150	268	36	10	15,15

Fabricado de acuerdo con IEC 60900.

**Juego de destornilladores SoftFinish® electric**



**con llave de vaso hexagonal**

322

n° pdo.							€/unid.
00853	4.0	125	236	30	10.2	10	14,05
00855	5.0	125	236	30	11.2	10	14,05
00856	5.5	125	236	30	11.2	10	14,05
00857	6.0	125	236	30	12.2	10	14,05
00858	7.0	125	243	36	14.5	10	16,37
00859	8.0	125	243	36	15.2	10	17,37
00860	9.0	125	243	36	16	10	18,35
00861	10.0	125	243	36	17.2	10	19,58
00864	13.0	125	243	41	22.2	5	25,51
00862	11.0	125	243	41	19.2	5	21,32
00865	14.0	125	243	41	23.2	5	26,60
00863	12.0	125	243	41	20.2	5	23,40
00866	15.0	125	243	41	25.2	5	31,92
00867	16.0	125	243	41	25.2	5	31,92
00868	17.0	125	243	41	27.2	5	31,92

Fabricado de acuerdo con IEC 60900.

**Destornillador de precisión PicoFinish® electric**



**Ranurado**

2270P

n° pdo.							€/unid.
42374	1.5	50	2	152	18	10	9,26
42375	2.0	50	2	152	18	10	7,84
42376	2.5	65	2.5	167	18	10	7,57
42377	3.0	65	3	167	18	10	7,57
42471	3.5	65	3.5	167	18	10	7,84

Fabricado de acuerdo con IEC 60900.

**Phillips**

2271P

n° pdo.							€/unid.
42379	PH00	50	2	152	18	10	11,57
42378	PH0	65	3	167	18	10	8,79
42380	PH1	65	4	167	18	10	10,74

Fabricado de acuerdo con IEC 60900.

**Comprobador de tensión SoftFinish® unipolar, para 110 - 250 voltios**



**ranurado, transparente, con clip de conexión**

25511

n° pdo.							€/unid.
34745	3.0	60	140	19	-	10	11,69
35378	3.0	60	140	19	-	5	13,30

**Comprobador de tensión de 220-250 voltios**



**ranurado, transparente, con clip de conexión**

2553

n° pdo.							€/unid.
05271	3.0	60	140	15	-	10	4,07
32201	3.0	60	140	15	-	5	5,69

**Comprobador de tensión de 150-250 voltios**



**ranurado, negro, con clip de conexión**

2557

n° pdo.							€/unid.
00456	3.0	60	160	17	-	10	12,31
31771	3.0	60	160	17	-	1	13,92

### Juego de destornilladores SoftFinish®



#### en surtido de 12 unid.

302HK12

n° pdo.	🏠	€/unid.
41002	1	104,04
⊖		4.0 mm x 100 mm / 3.5 mm x 100 mm / 6.5 mm x 150 mm
⊕		PH1 x 80 mm / PH2 x 100 mm / PH3 x 150 mm
⊕		PZ1 x 80 mm / PZ2 x 100 mm
⊕		T15 x 80 mm / T20 x 100 mm / T25 x 100 mm / T30 x 115 mm

### Juego de destornilladores SoftFinish®



#### ranurados, Phillips, de 6 unid.

302HK6SO

n° pdo.	🏠	€/unid.
07152	1	48,04
⊖		3.5 mm x 100 mm / 4.5 mm x 125 mm / 5.5 mm x 150 mm / 6.5 mm x 150 mm
⊕		PH1 x 80 mm / PH2 x 100 mm

#### ranurados, Phillips, Pozidriv, de 6 unid.

302HK601

n° pdo.	🏠	€/unid.
26113	1	54,19
⊖		4.0 mm x 100 mm / 5.5 mm x 125 mm / 6.5 mm x 150 mm
⊕		PH1 x 80 mm / PH2 x 100 mm
⊕		PZ2 x 100 mm

#### ranurados, Pozidriv, de 6 unid.

302ZK6SO

n° pdo.	🏠	€/unid.
07153	1	49,39
⊖		3.5 mm x 100 mm / 4.5 mm x 125 mm / 5.5 mm x 150 mm / 6.5 mm x 150 mm
⊕		PZ1 x 80 mm / PZ2 x 100 mm

#### TORX® MagicSpring®, de 6 unid.

362RK6SO

n° pdo.	🏠	€/unid.
27746	1	65,16
⊕		T10 x 80 mm / T15 x 80 mm / T20 x 100 mm / T25 x 100 mm / T30 x 115 mm / T40 x 130 mm

#### TORX®, de 7 unid.

362K7

n° pdo.	🏠	€/unid.
01299	1	52,94
⊕		T8 x 60 mm / T9 x 60 mm / T10 x 80 mm / T15 x 80 mm / T20 x 100 mm / T25 x 100 mm / T30 x 115 mm

#### TORX®, de 6 unid.

362K6SO

n° pdo.	🏠	€/unid.
07155	1	48,54
⊕		T10 x 80 mm / T15 x 80 mm / T20 x 100 mm / T25 x 100 mm / T30 x 115 mm / T40 x 130 mm

#### TORX® Tamper Resistant (con taladro), de 6 unid.

362TRK6

n° pdo.	🏠	€/unid.
24506	1	61,68
⊕		T10H x 80 mm / T15H x 80 mm / T20H x 100 mm / T25H x 100 mm / T30H x 115 mm / T40H x 130 mm

## CUADRO INFORMATIVO: Destornillador SoftFinish® de Wiha



### El experto para aplicaciones en seco.

- El mango SoftFinish® garantiza una adherencia óptima en aplicaciones en seco en los ámbitos industrial y profesional.
- La posición de las zonas duras y blandas en el mango apoya el acceso perfecto al girar de forma rápida y potente.

Juego de destornilladores SoftFinish®



ranurados, Phillips, Pozidriv, de 6 unid.

311K6

n° pdo.	🏠	€/unid.
26146	1	67,61
⊕	PH1 x 80 mm / PH2 x 100 mm / PH3 x 150 mm	
⊕	PZ1 x 80 mm / PZ2 x 100 mm / PZ3 x 150 mm	

Juego de destornilladores SoftFinish®



ranurados, Phillips, de 6 unid., con prolongación hexagonal

308HK6

n° pdo.	🏠	€/unid.
21248	1	60,20
⊖	3.5 mm x 75 mm / 4.5 mm x 90 mm / 5.5 mm x 100 mm / 7.0 mm x 125 mm	
⊕	PH1 x 80 mm / PH2 x 100 mm	

ranurados, Pozidriv, de 6 unid., con prolongación hexagonal

308ZK6

n° pdo.	🏠	€/unid.
21249	1	62,68
⊖	3.5 mm x 75 mm / 4.5 mm x 90 mm / 5.5 mm x 100 mm / 7.0 mm x 125 mm	
⊕	PZ1 x 80 mm / PZ2 x 100 mm	

Juego de destornilladores SoftFinish®



con llave de vaso hexagonal, de 5 unid.

341K5

n° pdo.	🏠	€/unid.
01034	1	59,58
○	5.5 mm x 125 mm / 7.0 mm x 125 mm / 8.0 mm x 125 mm / 10.0 mm x 125 mm / 13.0 mm x 125 mm	



**Juego de destornilladores SoftFinish®**



**ranurados, Phillips, de 6 unid., con varilla hexagonal continua y plancha de acero maciza**

530HK6

n° pdo.	€/unid.
21250	77,55
⊖	3.5 mm x 75 mm / 4.5 mm x 90 mm / 5.5 mm x 100 mm / 6.5 mm x 125 mm
⊕	PH1 x 80 mm / PH2 x 100 mm

**Ranurado con varilla hexagonal continua y plancha de acero maciza**

530ZK6

n° pdo.	€/unid.
21251	78,79
⊖	4.5 mm x 90 mm / 3.5 mm x 75 mm / 5.5 mm x 100 mm / 6.5 mm x 125 mm
⊕	PZ1 x 80 mm / PZ2 x 100 mm

**CUADRO INFORMATIVO:  
Plancha de acero y prolongación hexagonal**



- La plancha de acero maciza situada en el extremo del mango del destornillador permite aplicar golpes de martillo precisos, por ejemplo, para soltar los tornillos atascados.
- La unión directa de la plancha de acero y la varilla permite la transmisión sin pérdidas de la energía de impacto.
- La varilla, incluye una prolongación hexagonal, para aplicar con una llave un refuerzo del par de apriete.

**Juego de destornilladores de precisión PicoFinish®**



**ranurados, Phillips, de 7 unid.**

260PK701

n° pdo.	€/unid.
42991	46,16
⊖	1.5 mm x 40 mm / 2.0 mm x 40 mm / 2.5 mm x 50 mm / 3.0 mm x 50 mm
⊕	PH00 x 40 mm / PH0 x 50 mm / PH1 x 60 mm

**ranurados, Phillips, de 7 unid., incl. soporte**

260PK601

n° pdo.	€/unid.
42990	41,26
⊖	1.5 mm x 40 mm / 2.0 mm x 40 mm / 2.5 mm x 50 mm / 3.0 mm x 50 mm
⊕	PH00 x 40 mm / PH0 x 50 mm soporte

**TORX® MagicSpring®, de 7 unid., incl. soporte**

267PRK601

n° pdo.	€/unid.
42998	72,35
⊕	T6 x 40 mm / T7 x 40 mm / T8 x 40 mm / T9 x 50 mm / T10 x 50 mm / T15 x 60 mm soporte

**TORX®, de 7 unid., incl. soporte**

267PK601

n° pdo.	€/unid.
42996	58,42
⊕	T7 x 40 mm / T8 x 40 mm / T9 x 50 mm / T10 x 50 mm / T15 x 60 mm / T20 x 60 mm soporte

**TORX®, de 7 unid., incl. soporte**



267PK6M01

n° pdo.	€/unid.
42997	63,63
⊕	T4 x 40 mm / T5 x 40 mm / T6 x 40 mm / T7 x 40 mm / T8 x 40 mm / T9 x 50 mm soporte

**Con cabeza esférica hexagonal, de 7 unid., incl. soporte**

264PK601

n° pdo.		€/unid.
42993	1	56,24

	0.9 mm x 0,035" x 40 mm
	1.3 mm x 0.05" x 40 mm / 1.5 mm x 50 mm / 2.0 mm x 50 mm / 2.5 mm x 60 mm / 3.0 mm x 60 mm



soporte

Cabeza esférica a partir del ancho de llave 1,3

**Hexagonal, de 7 unid., incl. soporte**

263PK601

n° pdo.		€/unid.
42992	1	41,77

	0.9 mm x 0,035" x 40 mm
	1.3 mm x 0,05" x 40 mm / 1.5 mm x 50 mm / 2.0 mm x 5/64" x 50 mm / 2.5 mm x 60 mm / 3.0 mm x 60 mm

soporte

**Llaves de vaso hexagonal, de 7 unid., incl. soporte**

265PK601

n° pdo.		€/unid.
42994	1	75,40

	2.5 mm x 60 mm / 3.0 mm x 60 mm / 3.5 mm x 60 mm / 4.0 mm x 60 mm / 5.0 mm x 60 mm / 5.5 mm x 60 mm
---	--

soporte





**Juego de destornilladores de precisión PicoFinish®**



**en surtido, de 8 unid., incl. pinzas para dispositivos iPhone®/Apple®**

266PK801

n° pdo.		€/unid.
42995	1	107,88

	PH000 x 40 mm / PH00 x 40 mm
	PL1 x 40 mm / PL2 x 40 mm
	2.5 mm x 60 mm
	T3 x 40 mm
	Y000 x 40 mm
	2a, 120 mm

## Destornillador SoftFinish®



con varilla redonda para tornillos situados a mayor profundidad



con varilla redonda

## ranurado con varilla redonda para tornillos situados a mayor profundidad

302

n° pdo.					mm			€/unid.
00684	2.0	65	0.4	2	169	23	10	4,69
00685	2.5	75	0.4	2.5	179	23	10	5,05
00687	3.0	100	0.5	3	204	23	10	5,79
00689	3.0	150	0.5	3	254	23	10	6,92
00690	3.0	200	0.5	3	304	23	10	8,12
32383	3.0	300	0.5	3	404	23	5	9,29
00686	3.0	80	0.5	3	184	23	10	5,48
00691	3.5	100	0.6	3.5	204	23	10	5,91
26931	3.5	200	0.6	3.5	304	23	10	7,86
00692	4.0	100	0.8	4	211	30	10	6,71
00694	4.0	150	0.8	4	261	30	10	7,42
00695	4.0	200	0.8	4	311	30	10	8,55
00696	4.0	300	0.8	4	411	30	5	10,55
00697	4.5	125	0.8	4.5	236	30	10	8,43
27753	4.5	80	0.8	4.5	191	30	10	7,66
00698	5.5	125	1.0	5.5	236	30	10	10,17
00700	5.5	150	1.0	5.5	261	30	10	10,73
00701	5.5	200	1.0	5.5	311	30	10	11,59
00702	5.5	300	1.0	5.5	411	30	5	12,72
32384	6.0	300	1.0	6	418	36	5	12,96

## ranurado con varilla redonda

3022

n° pdo.					mm			€/unid.
27754	6.0	100	1.0	5.5	218	36	10	10,95
27755	6.0	150	1.0	5.5	268	36	10	11,85
00704	6.5	100	1.2	6	218	36	10	11,09
00703	6.5	150	1.2	6	268	36	10	11,72
00706	6.5	200	1.2	6	318	36	10	12,86
00708	8.0	150	1.2	7	274	41	10	14,84
00707	8.0	175	1.2	7	299	41	5	15,39
00709	8.0	175	1.6	7	299	41	5	15,85
32399	8.0	300	1.2	7	424	41	5	16,83
00711	10.0	200	1.6	8	324	41	5	19,09
32400	10.0	300	1.6	8	424	41	5	20,58
00712	12.0	250	2.0	8	374	41	5	24,38
00713	14.0	250	2.5	11	374	41	5	26,94

## Phillips con varilla redonda

311

n° pdo.				mm			€/unid.
00754	PH0	60	3	164	23	10	6,47
27756	PH0	100	3	204	23	10	7,29
00756	PH1	80	4.5	191	30	10	7,58
27757	PH1	100	4.5	211	30	10	8,68
00757	PH1	200	4.5	311	30	10	10,03
03738	PH1	300	4.5	411	30	5	11,47
00759	PH2	100	6	218	36	10	10,71
27758	PH2	150	6	268	36	10	12,08
00760	PH2	200	6	318	36	10	12,60
03739	PH2	300	6	418	36	5	14,05
00762	PH3	150	8	274	41	10	15,39
00763	PH4	200	10	324	41	5	20,82

## Pozidriv con varilla redonda

313

n° pdo.				mm			€/unid.
00768	PZ0	60	3	164	23	10	7,61
00770	PZ1	80	4.5	191	30	10	9,04
26454	PZ1	300	4.5	411	30	5	12,60
00772	PZ2	100	6	218	36	10	12,44
26455	PZ2	300	6	418	36	5	15,97
00774	PZ3	150	8	274	41	10	18,71

## TORX® con cabeza esférica, de 6 unid.

362BE

n° pdo.				mm			€/unid.	
32250	T9	60	7/64"	2.8	164	23	10	10,11
32251	T10	60	1/8"	3.2	184	23	10	10,64
32252	T15	80	9/64"	3.6	191	30	10	10,90
32253	T20	80	5/32"	4	211	30	10	11,03
32254	T25	100	3/16"	4.8	218	36	10	11,64
32255	T27	115	7/32"	5.6	233	36	10	12,13
32256	T30	115	1/4"	6.4	233	36	10	13,14

## TORX® MagicSpring® con varilla redonda

362R

n° pdo.				mm			€/unid.
27736	T6	60	3.5	164	23	10	8,99
27737	T7	60	3.5	164	23	10	8,42
27738	T8	60	3.5	164	23	10	8,42
27739	T9	60	4	171	30	10	9,49
27740	T10	80	4	191	30	10	9,72
27741	T15	80	4	191	30	10	10,03
27742	T20	100	4	218	36	10	10,47
27743	T25	100	4.5	218	36	10	10,90
27811	T27	115	5.5	233	36	10	11,51
27744	T30	115	6	233	36	10	12,51
27745	T40	130	7	254	41	10	13,87

**TORX® con varilla redonda**

362

n° pdo.							€/unid.
26259	T3	60	2.5	164	23	10	9,05
26260	T4	60	2.5	164	23	10	9,05
01285	T5	60	2.5	164	23	10	9,05
01286	T6	60	3.5	164	23	10	6,84
01287	T7	60	3.5	164	23	10	6,84
01288	T8	60	3.5	164	23	10	6,84
01289	T9	60	4	171	30	10	7,39
01290	T10	80	4	191	30	10	7,58
01291	T15	80	4	191	30	10	7,58
01292	T20	100	4	218	36	10	8,01
01293	T25	100	4.5	218	36	10	8,58
01294	T27	115	5.5	233	36	10	8,79
01295	T30	115	6	233	36	10	9,56
01296	T40	130	7	254	41	10	9,56
01297	T45	130	8	254	41	5	12,46

**TORX® Tamper Resistant (con taladro), con varilla redonda**

362TR

n° pdo.						€/unid.
03106	T7H	60	164	23	10	11,17
03107	T8H	60	164	23	10	11,03
03108	T9H	60	171	30	10	11,03
26457	T10H	300	411	30	5	14,43
01305	T30H	115	233	36	10	12,64
01304	T27H	115	233	36	10	12,02
01303	T25H	100	211	30	10	11,78
01302	T20H	100	211	30	10	11,64
01301	T15H	80	191	30	10	11,41
01300	T10H	80	191	30	10	11,15
28005	T20H	300	411	30	5	14,93
26458	T15H	300	411	30	5	14,93
01306	T40H	130	254	41	10	13,14

**TORX PLUS® MagicSpring® con varilla redonda**

362RIP

n° pdo.							€/unid.
28760	6IP	60	3.5	164	23	10	10,90
28761	7IP	60	3.5	164	23	10	10,90
28762	8IP	60	3.5	164	23	10	10,90
28763	9IP	60	4	171	30	10	12,02
28764	10IP	80	4	191	30	10	12,51
28765	15IP	80	4	191	30	10	12,88
28766	20IP	100	4	218	36	10	13,63

362IP

n° pdo.							€/unid.
26091	6IP	60	3.5	164	23	10	8,62
26093	7IP	60	3.5	164	23	10	8,62
26095	8IP	60	3.5	164	23	10	8,62
26097	9IP	60	4	171	30	10	9,23
26099	10IP	80	4	191	30	10	9,49
26101	15IP	80	4	191	30	10	9,85
26103	20IP	100	4	218	36	10	10,47
26105	25IP	100	4.5	218	36	10	10,85
26107	27IP	115	5.5	233	36	10	11,41
26109	30IP	115	6	233	36	10	12,21
26111	40IP	130	7	254	41	10	13,03

**con cabeza esférica hexagonal MagicRing® con varilla hexagonal**

367R

n° pdo.						€/unid.
26077	3.0	100	204	23	10	7,75
26079	4.0	100	211	30	10	8,50
26081	5.0	100	211	30	10	9,72
26083	6.0	125	243	36	10	11,78
26085	8.0	150	268	36	10	16,60

**con cabeza esférica hexagonal con varilla hexagonal**

367

n° pdo.						€/unid.
26303	1.5	75	179	23	10	7,00
26304	2.0	100	204	23	10	6,62
26305	2.5	100	204	23	10	6,32
26328	3.0	100	204	23	10	6,32
26329	4.0	100	211	30	10	6,88
26330	5.0	100	211	30	10	7,80
26331	6.0	125	243	36	10	9,49
26332	8.0	150	268	36	10	13,14
26333	10.0	150	271	41	5	15,87
26307	12.0	150	271	41	5	21,32

**hexagonal con varilla hexagonal**

356

n° pdo.						€/unid.
32264	1.5	60	164	23	10	4,15
32265	2.0	60	164	23	10	3,84
26190	2.5	75	179	23	10	3,89
26191	3.0	75	179	23	10	3,89
26192	4.0	75	186	30	10	4,33
26193	5.0	75	186	30	10	5,27
26194	6.0	100	218	36	10	7,13
26195	8.0	100	218	36	10	8,73

### Destornillador SoftFinish®



#### hexagonal acodado

357

n° pdo.				mm			€/unid.
26230	3.0	35	20	139	23	10	4,58
26231	4.0	40	25	151	30	10	5,33
26232	5.0	45	28	156	30	10	6,57
26233	6.0	50	32	168	36	10	7,64
26234	8.0	60	36	178	36	10	9,97

### Herramienta de accionamiento de bornes de conexión SoftFinish®



#### Ranura 3,0 x 0,5 mm

3023

n° pdo.					mm			€/unid.
43894	3.0	0.5	70	3	174	23	10	16,39

### Destornillador SoftFinish®



#### con llave de vaso hexagonal con varilla redonda

341

n° pdo.				mm			€/unid.
01018	4.0	6.9	125	236	30	10	9,23
01020	5.0	7.9	125	236	30	10	9,23
01021	5.5	7.9	125	236	30	10	9,23
01022	6.0	8.9	125	236	30	10	9,23
01023	7.0	10.9	125	243	36	10	11,64
01024	8.0	11.9	125	243	36	10	11,90
01025	9.0	12.9	125	243	36	10	12,51
01026	10.0	14.4	125	243	36	10	12,64
01027	11.0	15.9	125	249	41	5	16,10
01028	12.0	16.9	125	249	41	5	17,08
01029	13.0	18.4	125	249	41	5	17,96
01030	14.0	19.4	125	249	41	5	17,96
01031	15.0	21.9	125	249	41	5	22,04
01032	16.0	21.9	125	249	41	5	22,04
01033	17.0	23.4	125	249	41	5	22,04

#### con llave de vaso hexagonal con varilla redonda corta

343

n° pdo.				mm			€/unid.
01076	5.5	8	65	176	30	10	9,23
01077	6.0	9	65	176	30	10	9,23
01078	7.0	11	65	183	36	10	11,64
01079	8.0	12	65	183	36	10	12,02
01081	10.0	14	65	183	36	10	12,64

Destornillador SoftFinish®



con llave de vaso hexagonal con varilla redonda y prolongación hexagonal

347Z

n° pdo.					mm			€/unid.
02836	3/16"	8	125	10	231	30	10	11,03
02837	1/4"	10	125	10	238	36	10	12,17
02838	5/16"	12	125	10	238	36	10	13,02
02839	3/8"	14	125	10	238	36	10	14,54
02840	7/16"	16	125	13	246	41	10	18,18

Destornillador SoftFinish®



cuadrado

344

n° pdo.					mm			€/unid.
26212	M4	6.8	11	125	236	30	10	16,73
26213	M5	8.3	13	125	236	30	10	16,96
26216	M6	10.05	16	125	236	30	10	18,08
26214	M8	12.05	18	125	243	36	10	22,79
26217	M10	15.05	22	125	243	36	10	30,36

Destornillador SoftFinish®



con llave de vaso hexagonal con vástago flexible

372

n° pdo.				mm			€/unid.
01435	5.0	8	150	261	30	10	22,18
01436	5.5	8	150	261	30	10	22,18
01437	6.0	9	150	261	30	10	22,18
01438	7.0	11	150	268	36	10	23,52
01439	8.0	12	150	268	36	10	23,52
01440	10.0	14	175	293	41	10	25,16
01443	13.0	19	175	293	41	10	27,89

Destornillador SoftFinish®



con llave de vaso hexagonal con varilla redonda y prolongación hexagonal

347

n° pdo.					mm			€/unid.
01092	7.0	11	125	10	238	36	10	12,64
01093	8.0	12	125	10	238	36	10	13,14
01094	9.0	13	125	10	238	36	10	14,37
01095	10.0	14.5	125	10	238	36	10	15,00
01096	11.0	16	125	13	246	41	10	17,72
01097	12.0	17	125	13	246	41	10	18,22
01098	13.0	19	125	13	246	41	10	19,32

### Destornillador SoftFinish®



#### Ranurado con varilla hexagonal continua y plancha de acero maciza

530

n° pdo.										€/unid.
03223	3.5•	75	0.6	4			186	30	10	11,03
03224	4.5•	90	0.8	4			201	30	10	12,07
03225	5.5•	100	1.0	5	8		213	36	10	15,61
03226	6.5•	125	1.2	6	10		238	36	10	19,32
03228	8.0•	150	1.2	8	13		271	41	5	26,14
03230	10.0•	175	1.6	8	13		296	41	5	32,45
03231	12.0•	200	2.0	10	16		321	41	5	41,25
03232	14.0•	250	2.5	10	16		371	41	5	49,92

\* Tamaño complementario a las dimensiones DIN

#### Phillips con varilla hexagonal continua y plancha de acero maciza

531

n° pdo.									€/unid.
03237	PH1	80	5	8	186	30	10	14,01	
03238	PH2	100	6	10	213	36	10	19,57	
03239	PH3	150	8	13	268	41	10	28,76	

#### Pozidriv con varilla hexagonal continua y plancha de acero maciza

532

n° pdo.									€/unid.
03245	PZ1	80	5	8	186	30	10	14,86	
03246	PZ2	100	6	10	213	36	10	21,44	
03247	PZ3	150	8	13	268	41	10	30,47	

### Destornillador SoftFinish®



#### ranurado con varilla redonda y escala en mm grabada con láser

3021

n° pdo.									€/unid.
36085	4.0	100	0.8	4	211	30	20 - 90	10	7,34
35397	5.5	125	1.0	5.5	236	30	30 - 110	10	11,29

#### Phillips con varilla redonda y escala en mm grabada con láser

3111

n° pdo.									€/unid.
36072	PH1	80	4.5	191	30	20 - 70	10	8,33	
35398	PH2	100	6	218	36	20 - 90	10	11,78	

### Destornillador SoftFinish®



#### ranurado con función de sujeción

398

n° pdo.									€/unid.
32867	2.5	75	0.4	186	30	5		19,48	
32868	3.0	100	0.5	211	30	5		20,15	
32869	4.0	125	0.8	243	36	5		24,91	
32870	5.0	150	1.0	268	36	5		28,78	
32871	6.0	175	1.2	293	36	5		32,21	

#### Phillips con función de sujeción

397

n° pdo.									€/unid.
32406	PH0	100	211	30	5			22,80	
32404	PH1	125	236	36	5			27,44	
32405	PH2	175	286	36	5			31,95	

## Destornillador SoftFinish®



### ranurado con varilla redonda corta

302SY

n° pdo.								€/unid.
26964	4.0	25	0.8	4	81	34	10	7,20
26965	5.5	25	1.0	5.5	81	34	10	7,32
26966	6.5	25	1.2	6.5	81	34	10	7,88
26967	8.0	25	1.2	8	81	34	10	8,58

### Phillips con varilla redonda corta, Stubby

311SY

n° pdo.							€/unid.
26968	PH1	25	4.5	81	34	10	7,39
26969	PH2	25	6	81	34	10	8,58
26970	PH3	25	8	81	34	10	8,92

### Phillips con varilla redonda corta, Stubby

313SY

n° pdo.							€/unid.
26971	PZ1	25	4.5	81	34	10	8,69
26972	PZ2	25	6	81	34	10	9,42
26973	PZ3	25	8	81	34	10	10,28

## Destornillador SoftFinish®



308

n° pdo.								€/unid.
00731	3.5	75	0.6	4	186	10	10	6,62
00732	4.5	90	0.8	4	201	10	10	8,62
00733	5.5	100	1.0	5	8	213	10	11,78
00734	6.5	125	1.2	6	10	238	10	12,88
00735	7.0	125	1.1	6	10	238	10	12,88
00736	8.0	150	1.2	8	13	268	10	17,08
00737	9.0	150	1.4	8	13	268	10	17,08
00738	10.0	175	1.6	8	13	293	10	20,56
00739	12.0	200	2.0	10	16	318	5	24,66
00740	14.0	250	2.5	10	16	368	5	28,24

### Phillips con varilla hexagonal y prolongación hexagonal

312

n° pdo.								€/unid.
00764	PH1	80	5	8	186	30	10	9,49
00765	PH2	100	6	10	213	36	10	12,76
00766	PH3	150	8	13	268	41	10	18,08
00767	PH4	200	10	16	318	41	5	23,16

### Pozidriv con varilla hexagonal y prolongación hexagonal

314

n° pdo.								€/unid.
00776	PZ1	80	5	8	186	30	10	11,64
00777	PZ2	100	6	10	213	36	10	15,24
00778	PZ3	150	8	13	268	41	10	22,04
00779	PZ4	200	10	16	318	41	5	27,99

## CUADRO INFORMATIVO: Pentalobe



### El perfil de seguridad para dispositivos Apple

- Ideal para trabajos de reparación en smartphones, tablet-PCs y ordenadores portátiles Apple.
- Atención: Es imprescindible tener en cuenta las condiciones de garantía del fabricante del dispositivo.



### Destornillador de precisión PicoFinish®



#### Ranurado

260P

n° pdo.							€/unid.
42381	0.8	40	2	134	9	10	10,73
42382	1.0	40	2	134	9	10	9,61
42383	1.2	40	2	134	9	10	8,44
42384	1.5	40	2	134	9	10	7,47
42385	1.5	60	2	154	9	10	7,62
42386	1.8	40	2	134	9	10	7,47
42387	1.8	60	2	154	9	10	7,62
42388	2.0	40	2	140	18	10	6,22
42389	2.0	60	2	160	18	10	6,50
42390	2.0	100	2	200	18	10	6,78
42391	2.5	50	2.5	150	18	10	5,96
42392	2.5	75	2.5	175	18	10	6,22
42393	2.5	100	2.5	200	18	10	6,50
42394	3.0	50	3	150	18	10	5,96
42395	3.0	100	3	200	18	10	6,50
42397	3.5	60	3.5	160	18	10	6,56
42398	4.0	60	4	160	18	10	6,91
42399	4.0	100	4	200	18	10	7,41

#### Phillips

261P

n° pdo.							€/unid.
42403	PH000	40	2	134	9	10	11,90
42402	PH00	40	2	134	9	10	8,59
42413	PH00	60	2	154	9	10	9,34
42401	PH0	50	3	150	18	10	6,56
42414	PH0	75	3	175	18	10	7,41
42415	PH1	60	4	160	18	10	7,83
42416	PH1	80	4	180	18	10	8,23

#### Pozidriv

262P

n° pdo.							€/unid.
42418	PZ0	50	3	150	18	10	7,05
42419	PZ1	60	4	160	18	10	8,59

#### PHP00 con pivote

2611P

n° pdo.							€/unid.
43882	PHP000	40	2.5	134	9	10	16,09

#### TORX® MagicSpring®

267PR

n° pdo.							€/unid.
42501	T6	40	2.5	140	18	10	12,03
42502	T7	40	2.5	140	18	10	12,03
42503	T8	40	2.5	140	18	10	12,03
42504	T9	50	3	150	18	10	12,03
42505	T10	50	3	150	18	10	12,46
42506	T15	60	3.5	150	18	10	12,87

#### TORX®

267PR

n° pdo.							€/unid.
42474	T1	40	2.5	134	9	10	13,64
42475	T2	40	2.5	134	9	10	13,64
42476	T3	40	2.5	134	9	10	13,64
42477	T4	40	2.5	134	9	10	13,64
42478	T5	40	2.5	134	9	10	12,46
42479	T6	40	2.5	140	18	10	9,48
42480	T7	40	2.5	140	18	10	9,48
42481	T8	40	2.5	140	18	10	9,48
42482	T9	50	3	150	18	10	9,76
42483	T10	50	3	150	18	10	9,76
42484	T15	60	3.5	160	18	10	10,17
42485	T20	60	4	160	18	10	10,17

#### Pentalobe

266P

n° pdo.							€/unid.
42464	PL1	40	2.5	134	9	10	16,48
42465	PL2	40	2.5	134	9	10	16,48
42466	PL3	40	2.5	134	9	10	16,48
42467	PL4	40	2.5	134	9	10	16,48
42468	PL5	40	2.5	134	9	10	16,48
42469	PL6	40	2.5	140	18	10	12,81

#### Tipo Y

266PY

n° pdo.							€/unid.
42470	Y000	40	2	134	9	10	16,48

#### con cabeza esférica hexagonal

264P

n° pdo.						€/unid.
42431	1.3	40	134	9	10	11,14
42432	1.5	50	150	18	10	10,30
42433	2.0	50	150	18	10	9,48
42434	2.5	60	160	18	10	8,72
42435	3.0	60	160	18	10	8,44

#### hexagonal

263P

n° pdo.						€/unid.
42420	0.7	40	134	9	10	8,72
42421	0.9	40	134	9	10	8,44
42422	1.3	40	134	9	10	7,41
42423	1.5	50	144	9	10	7,13
42424	2.0	50	150	18	10	6,22
42425	2.5	60	160	18	10	6,22
42426	3.0	60	160	18	10	5,89

#### cabeza esférica hexagonal, versión en pulgadas

264PZ

n° pdo.						€/unid.
42436	1/16"	50	150	18	10	11,14
42440	5/64"	50	150	18	10	9,61
42438	3/32"	50	150	18	10	9,61
42441	7/64"	60	160	18	10	9,61
42437	1/8"	60	160	18	10	9,15
42442	9/64"	60	160	18	10	9,15
42439	5/32"	60	160	18	10	9,15

### Destornillador de precisión PicoFinish®



#### hexagonal

263PZ

n° pdo.			mm			€/unid.
42427	1/16"	50	144	9	10	6,31
42428	1/8"	60	160	18	10	6,31
42429	3/32"	60	160	18	10	6,31
42430	7/64"	60	160	18	10	6,31

### Destornillador de precisión PicoFinish®



#### con llave de vaso hexagonal

265P

n° pdo.			mm			€/unid.
42443	1.5	60	160	18	10	14,38
42444	1.8	60	160	18	10	13,84
42445	2.0	60	160	18	10	13,84
42446	2.5	60	160	18	10	12,32
42447	3.0	60	160	18	10	12,32
42448	3.2	60	160	18	10	12,32
42449	3.5	60	160	18	10	12,87
42450	4.0	60	160	18	10	12,87
42451	4.5	60	160	18	10	13,17
42452	5.0	60	160	18	10	13,17
42453	5.5	60	160	18	10	13,17
42454	6.0	60	160	18	10	13,17
42455	7.0	60	160	18	10	13,84

### Elevador PicoFinish



268P

n° pdo.			mm				€/unid.	
42507	50	3.5	150	18	1	3.5	10	12,59

### Destornillador pequeño



#### ranurado rojo transparente, con clip de conexión

500

n° pdo.				mm			€/unid.
01537	3.0	40	3	100	11	50	2,34
01538	3.0	60	3	120	11	50	2,34
01539	3.0	80	3	140	11	50	2,34

### Destornillador pequeño



#### ranurado amarillo transparente

509

n° pdo.				mm			€/unid.
01548	2.0	40	2	85	8	50	0,88

### Escariador



#### con punta cuadrada y mango de plástico

300

n° pdo.			mm			€/unid.
00679	6	100	185	34	10	7,78

### Granete con mango de plástico





#### con punta redonda y mango de plástico

301

n° pdo.			mm			€/unid.
00683	6	100	185	34	10	7,65

### Imantador



en blíster			40010
n° pdo.			€/unid.
01508	-	5	12,20
02568	-	5	13,81

### Juego de varillas de repuesto de 13 mm de anchura



de 10 unid. para rascadores universales, en blíster			SB43040K10
n° pdo.		€/unid.	
27606	5	10,51	

### Rascador universal SoftFinish®



			40010
n° pdo.		€/unid.	
23159	5	30,71	

### Juego de rascadores universales SoftFinish®



de 12 unid., en blíster			SB4304010
n° pdo.		€/unid.	
26920	1	38,28	

Rascador universal SoftFinish® 27.5 mm (23159)

Juego de varillas de repuesto de 13 mm de anchura de 10 unid. para rascadores universales, en blíster (27606)

## Juego de destornilladores MicroFinish



ranurado, Phillips, con varilla hexagonal continua y plancha de acero maciza, de 5 unid.

5533HK5

n° pdo.		🏠	€/unid.
29138		1	89,58
⊖	5.5 mm x 100 mm / 6.5 mm x 125 mm / 8.0 mm x 150 mm		
⊕	PH1 x 80 mm / PH2 x 100 mm		

ranurado, Pozidriv, con varilla hexagonal continua y plancha de acero maciza, de 5 unid.

5533ZK5

n° pdo.		🏠	€/unid.
29139		1	90,81
⊖	5.5 mm x 100 mm / 6.5 mm x 125 mm / 8.0 mm x 150 mm		
⊕	PZ1 x 80 mm / PZ2 x 100 mm		

### CUADRO INFORMATIVO: Destornillador MicroFinish de Wiha



**El especialista para aplicaciones en húmedo y con aceite.**

- La estructura superficial microfina del mango del destornillador ofrece una sujeción óptima al usuario, incluso con las manos manchadas de aceite o mojadas.
- La posición de las zonas duras y blandas en el mango apoya el acceso perfecto al girar de forma rápida y potente.

## Destornillador MicroFinish



TORX® con varilla redonda

5527

n° pdo.	⊕	↔	●	mm	+	🏠	€/unid.
29162	T10	80	4	192	30	10	10,50
29163	T15	80	4	192	30	10	10,50
29164	T20	100	4	212	30	10	10,74
29165	T25	100	4.5	212	30	10	11,22

## Destornillador MicroFinish



5533

n° pdo.	⊖	↔	⊖	⊕	mm	+	🏠	€/unid.
29133	4.5	90	0.8	4	201	10	13,18	
29134	5.5	100	1.0	5	213	10	16,85	
29135	6.5	125	1.2	6	238	10	19,03	
29136	8.0	150	1.2	8	271	5	25,26	
29137	10.0	175	1.6	8	296	5	32,47	

Phillips con varilla hexagonal continua y plancha de acero maciza

5534

n° pdo.	⊕	↔	⊕	○	mm	+	🏠	€/unid.
29149	PH1	80	5	8	187	30	10	14,65
29150	PH2	100	6	10	214	36	10	20,50
29151	PH3	150	8	13	271	41	10	30,26

Pozidriv con varilla hexagonal continua y plancha de acero maciza

5535

n° pdo.	⊕	↔	⊕	○	mm	+	🏠	€/unid.
29158	PZ1	80	5	8	187	30	10	15,62
29159	PZ2	100	6	10	214	36	10	22,21

Juego de destornilladores SoftFinish® ESD



ranurados, Phillips, de 5 unid.

302ESDHK501

n° pdo.		€/unid.
27252	1	47,19
	3.0 mm x 100 mm / 4.0 mm x 100 mm	
	PH0 x 60 mm / PH1 x 80 mm / PH2 x 100 mm	

IEC 61340-5-1.

Juego de destornilladores SoftFinish® ESD



TORX®, de 5 unid.

362ESDK5

n° pdo.		€/unid.
27253	1	45,83
	T6 x 60 mm / T8 x 60 mm / T9 x 60 mm / T10 x 80 mm / T15 x 80 mm	

IEC 61340-5-1.

CUADRO INFORMATIVO:  
**Herramientas con derivación electrostática ESD**

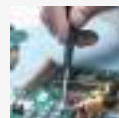

**Los componentes electrónicos sensibles pueden resultar dañados de forma irreparable incluso con la menor tensión.**

- Las herramientas disipadoras de Wiha derivan la energía eléctrica de forma controlada y segura.
- Las herramientas ESD cumplen la norma ESD IEC 61340-5-1.
- Los mangos de las herramientas ESD tienen una resistencia superficial de  $10^6 - 10^9$  ohmios.

## Destornillador SoftFinish® ESD



### Ranurado

302ESD

n° pdo.				mm			€/unid.
08179	2.5	75	0.4	179	23	10	6,74
27150	3.0	100	0.5	204	23	10	7,61
27151	4.0	100	0.8	211	30	10	8,79
08182	5.5	125	1.0	236	30	10	13,14
08183	6.5	150	1.2	268	36	10	15,24

### Phillips

311ESD

n° pdo.				mm			€/unid.
08184	PH0	60	3	164	23	10	8,73
08185	PH1	80	4.5	191	30	10	10,54
08186	PH2	100	6	218	36	10	14,01

### Pozidriv

313ESD

n° pdo.				mm			€/unid.
26928	PZ0	60	3	164	23	10	9,85
26929	PZ1	80	4.5	191	30	10	11,78

### TORX®

362ESD

n° pdo.				mm			€/unid.
31432	T3	60	2.5	164	23	10	11,78
27148	T4	60	2.5	164	23	10	11,78
27641	T5	60	3.5	164	23	10	9,09
27149	T6	60	3.5	164	23	10	9,09
31901	T7	60	3.5	164	23	10	9,09
22436	T8	60	3.5	164	23	10	9,09
27145	T9	60	4	171	30	10	9,60
27144	T10	80	4	191	30	10	9,97
27146	T15	80	4	191	30	10	10,41
27147	T20	100	4	218	36	10	10,54

## Juego de destornilladores de precisión PicoFinish® ESD



### ranurados, Phillips, de 7 unid., incl. soporte

270PK601

n° pdo.		€/unid.
43707	1	57,81
	1 x 1.5 mm x 40 mm / 1 x 2.0 mm x 40 mm / 1 x 2.5 mm x 50 mm / 1 x 3.0 mm x 50 mm	
	1 x PH0 x 50 mm / 1 x PH00 x 40 mm	
	1 x soporte	

### TORX®, de 7 unid., incl. soporte

277PK601

n° pdo.		€/unid.
43708	1	73,09
	1 x T5 x 40 mm / 1 x T6 x 40 mm / 1 x T7 x 40 mm / 1 x T8 x 40 mm / 1 x T10 x 50 mm / 1 x T15 x 60 mm	
	1 x soporte	

### Destornillador de precisión PicoFinish® ESD



#### Spår

270P

n° pdo.					mm			€/unid.
43669	1.5	0.2	40	2	134	9	10	9,45
43670	2.0	0.4	40	2	140	18	10	9,47
43671	2.5	0.4	50	2.5	150	18	10	9,51
43672	3.0	0.5	50	3	150	18	10	9,56
43673	3.5	0.6	50	3.5	160	18	10	9,58
43674	4.0	0.8	60	4	160	18	10	9,66

#### Phillips

271P

n° pdo.				mm			€/unid.
43675	PH000	40	2	134	9	10	11,84
43676	PH00	40	2	134	9	10	10,54
43677	PH0	50	3	150	18	10	9,45
43678	PH1	60	4	160	18	10	11,02

#### hexagonal

273P

n° pdo.				mm			€/unid.
43679	0.7	40	2.5	134	9	10	10,66
43680	0.9	40	2.5	134	9	10	10,70
43681	1.3	40	2.5	134	9	10	10,74
43682	1.5	50	2.5	144	9	10	10,86
43683	2.0	50	3	150	18	10	10,88
43684	2.5	60	3	160	18	10	11,34
43685	3.0	60	4	160	18	10	11,38

#### con llave de vaso hexagonal

275P

n° pdo.				mm			€/unid.
43686	2.5	4	60	160	18	10	16,39
43687	3.0	5	60	160	18	10	16,77
43688	3.5	6	60	160	18	10	17,04
43689	4.0	6	60	160	18	10	17,07
43690	5.0	7	60	160	18	10	17,33
43691	5.5	8	60	160	18	10	17,79

#### Pentalobe

276P

n° pdo.				mm			€/unid.
43692	PL1	40	2.5	134	9	10	18,24

#### Tipo Y

276PY

n° pdo.				mm			€/unid.
43693	Y000	40	2	134	9	10	18,24

### TORX®

277P

n° pdo.				mm			€/unid.
43694	T1	40	2.5	134	9	10	15,47
43695	T2	40	2.5	134	9	10	15,49
43696	T3	40	2.5	134	9	10	15,53
43697	T7	40	2.5	134	9	10	15,58
43698	T5	40	2.5	134	9	10	15,61
43699	T6	40	2.5	140	18	10	15,64
43700	T7	40	2.5	140	18	10	15,68
43701	T8	40	2.5	140	18	10	15,96
43702	T9	50	3	150	18	10	16,11
43703	T10	50	3	150	18	10	16,18
43704	T15	60	3.5	150	18	10	16,23
43705	T20	60	4	150	18	10	16,36

### Elevador PicoFinish® ESD



278P

n° pdo.				mm				€/unid.
43706	50	3.5	150	18	1	3.5	10	14,45

**Juego de extractores de tornillos**



hexagonal, de 17 unid., con broca espiral, incl. caja

40511

n° pdo.		€/unid.
03988	1	126,96

 1 x 2.3 / 1 x 2.8 / 1 x 3.4 / 1 x 4.5 / 1 x 5.7 / 1 x 6.8 / 1 x 9.0 / 1 x 11





 1 x 2.0 mm / 1 x 2.5 mm / 1 x 3.0 mm / 1 x 4.0 mm / 1 x 5.0 mm / 1 x 6.0 mm / 1 x 8.0 mm / 1 x 10.0 mm

1 x Caja

**Extractor de tornillos**





405A

n° pdo.		 mm			€/unid.
03847	2.0	85	6	10	7,66
03848	2.5	85	6	10	7,66
03849	3.0	85	6	10	7,66
03850	4.0	85	6	10	7,66
03851	5.0	85	6	10	7,66
03852	6.0	95	8	10	8,18
03853	8.0	95	10	10	9,25
03854	10.0	110	12	10	13,72

**Extractor de tornillos**



405B

n° pdo.		 mm		€/unid.
06725	2.3	53	10	3,64
06726	2.8	51	10	3,64
06727	3.4	70	10	3,96
06728	4.5	80	10	4,33
06729	5.7	93	10	6,92
06730	6.8	109	10	10,30
06731	9.0	117	10	15,46
06732	11	142	10	28,91







## **Destornilladores dinamométricos**

### **Potencia controlada para una mayor seguridad.**

El par de apriete correcto evita los daños en el material, los trabajos de repaso y protege ante los derechos de garantía. Esto hace, que las herramientas dinamométricas, totalmente certificadas, de Wiha para mecánicos, electricistas e ingenieros electrónicos sean esenciales, ya que combinan precisión con seguridad: Los destornilladores dinamométricos de Wiha, cumplen los requisitos de precisión conocidos con una precisión de activación del  $\pm 6\%$  con respecto al valor de escala fijado.

Las herramientas dinamométricas ajustadas de forma fija, aumentan la seguridad del proceso y, las herramientas de ajuste variable, se adaptan perfectamente sobre todo para el uso móvil. El sistema especial de varillas intercambiables, ofrece varillas intercambiables con diferentes perfiles. La prueba de unidades individuales garantizada con protocolo de comprobación de taller y la identificación de unidades individuales con número de identificación demuestran el alto nivel de calidad y de fabricación.

Para aplicaciones en la electricidad

**Juego de destornilladores dinamométricos TorqueVario®-S electric 0,8-5,0 Nm en surtido, de 19 unid., con limitación del par de apriete de ajuste variable, incl. bolsa plegable**  
Página 164



**Destornillador dinamométrico TorqueVario®-S electric con limitación del par de apriete de ajuste variable**  
Página 166



**Adaptador de par de apriete easyTorque electric para slimBits y soporte slimVario® en blíster**  
Página 167



**Destornillador dinamométrico con mango corredizo TorqueVario®-S T electric 5-14 Nm con limitación del par de apriete de ajuste variable**  
Página 171



Para aplicaciones en la mecánica

**Destornillador dinamométrico iTorque® con escala digital**  
Página 172



**Juego de destornilladores dinamométricos TorqueVario®-S 0,8-5,0 Nm en surtido, de 14 unid., con limitación del par de apriete de ajuste variable de incl. caja**  
Página 173



**Destornillador dinamométrico TorqueVario®-S con limitación del par de apriete de ajuste variable**  
Página 174



**Destornillador dinamométrico TorqueFix® con limitación del par de apriete preajustada de forma fija**  
Página 174



**Juego de destornilladores dinamométricos con mango en T TorqueVario®-ST 5-14 Nm en surtido de 12 unid. con limitación del par de apriete de ajuste variable de incl. caja**  
Página 178



**Destornillador dinamométrico con mango en T TorqueVario®-S T5-14 Nm con limitación del par de apriete de ajuste variable**  
Página 178



Para aplicaciones en la electrónica

**Juego de destornilladores dinamométricos TorqueVario®-S ESD 0,4-1,0 Nm en surtido, de 14 unid., con limitación del par de apriete de ajuste variable, incl. caja**  
Página 161



**Destornillador dinamométrico TorqueVario®-S ESD con limitación del par de apriete de ajuste variable**  
Página 181





0,8-5,0 Nm en surtido, de 19 unid., con limitación del par de apriete de ajuste variable, incl. bolsa plegable

2872T18

n° pdo.		€/unid.
36791	1	305,26
⊗	1 x Destornillador dinámico TorqueVario®-S electric con limitación del par de apriete de ajuste variable 1 x Herramienta de ajuste para destornillador dinámico con mango largo	
⊗	1 x Adaptador TorqueVario®-S electric para slimBits	
⊖	1 x 2.5 mm / 1 x 3.5 mm / 1 x 5.5 mm / 1 x 6.5 mm	
⊕	1 x PH1 / 1 x PH2	
⊗	1 x PZ1 / 1 x PZ2	
⊗	1 x SL/PZ1 / 1 x SL/PZ2	
⊗	1 x T9 / 1 x T10 / 1 x T15 / 1 x T20 / 1 x T25	
	1 x Bolsa plegable	

DIN EN ISO 6789.  
Fabricado de acuerdo con IEC 60900.

## CUADRO INFORMATIVO: Herramientas homologadas según VDE

Las herramientas homologadas según VDE de Wiha se someten a procedimientos de control de seguridad estrictos.



Todas las herramientas con el distintivo especial han sido probadas a 10.000 V CA y están, por tanto, autorizadas para operar a 1.000 V CA y a 1.500 V CC.

Para todos los trabajos en la cercanía o con piezas sometidas a tensión deberá utilizar las medidas de protección que correspondan a cada trabajo:

- equipos de protección individual aislantes
- dispositivos de protección aislantes
- herramientas aisladas

Antes del comienzo de los trabajos en componentes activos de equipos eléctricos y medios de producción sometidos a tensión, deberá asegurarse de que no haya tensión y durante la realización de dichos trabajos.

Esto es así si se cumplen las cinco reglas de seguridad:

Desconectar

- Asegurar que no haya reconexión
- Asegurarse de que no haya tensión
- Conectar a tierra y poner en cortocircuito
- Recubrir o aislar los componentes cercanos sometidos a tensión

Homologadas por el instituto de control y certificación VDE y comprobadas individualmente según la norma internacional IEC 60900:2012.



0,8-5,0 Nm en surtido, de 14 unid., con limitación del par de apriete de ajuste variable, incl. bolsa plegable		2872T13
n° pdo.		€/unid.
40674	1	259,92
⊖	1 x Destornillador dinámico TorqueVario®-S electric con limitación del par de apriete de ajuste variable	
	1 x Herramienta de ajuste para destornillador dinámico con mango largo	
○	1 x Destornillador con portabits SoftFinish® electric slimVario para slimBits	
⊖	Adaptador TorqueVario®-S electric para slimBits	
⊖	1 x 2.5 mm / 1 x 3.5 mm / 1 x 5.5 mm	
⊕	1 x PH1 / 1 x PH2	
⊕	1 x PZ1 / 1 x PZ2	
⊕	1 x SL/PZ1 / 1 x SL/PZ2	
	1 x Bolsa plegable	

DIN EN ISO 6789.  
Fabricado de acuerdo con IEC 60900.



Juego de destornilladores dinámicos TorqueVario®-S electric



Destornillador dinámico TorqueVario®-S electric



0,8-5,0 Nm PlusMinus/Pozidriv, de 5 unid., con limitación del par de apriete de ajuste variable

XX2872S3

n° pdo.		€/unid.
38074	1	212,30
⊗	1 x Destornillador dinámico TorqueVario®-S electric con limitación del par de apriete de ajuste variable	
	1 x Herramienta de ajuste para destornillador dinámico con mango largo	
⊗	1 x Adaptador TorqueVario®-S electric para slimBits	
⊕	1 x SL/PZ1 / 1 x SL/PZ2	

DIN EN ISO 6789.

Fabricado de acuerdo con IEC 60900.

con limitación del par de apriete de ajuste variable

2872

n° pdo.	Nm	VA%	⊗	⊕	⊖	⊗	€/unid.
26625	0.5 - 2	6 %	3.8	131	30	1	197,93
26626	0.8 - 5	6 %	3.8	138	36	1	205,67
26627	2 - 7	6 %	3.8	142	41	1	219,78

Fabricado de acuerdo con IEC 60900. DIN EN ISO 6789.

CUADRO INFORMATIVO: slimTECHNOLOGY

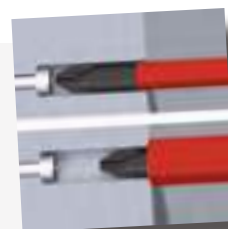

Wiha SoftFinish electric slimFix

- Accesibilidad sin obstáculos.
- Varillas hasta un 33 % más delgadas gracias al aislamiento integrado.
- Herramienta de accionamiento para grapas elásticas (geometría de accionamiento perfilada en forma de cuña).

Juego de adaptadores de par de apriete easy-Torque electric



0,8 Nm con soporte slimVario® y slimBits SL/PZ, de 4 unid., en blíster

29701080S4

n° pdo.		€/unid.
41476	5	81,56
1 x 0.8 Nm		
1 x SL/PZ1 / 1 x SL/PZ2		
1 x Destornillador con portabits SoftFinish® slimVario® electric		

Fabricado de acuerdo con IEC 60900.

2,0 Nm con soporte slimVario® y slimBits SL/PZ, de 4 unid., en blíster

29701200S4

n° pdo.		€/unid.
41477	5	81,56
1 x 2.0 Nm		
1 x SL/PZ1 / 1 x SL/PZ2		
1 x Destornillador con portabits SoftFinish® slimVario® electric		

Fabricado de acuerdo con IEC 60900.

2,8 Nm con soporte slimVario® y slimBits SL/PZ, de 4 unid., en blíster

29701280S4

n° pdo.		€/unid.
41478	5	81,56
1 x 2.8 Nm		
1 x SL/PZ1 / 1 x SL/PZ2		
1 x Destornillador con portabits SoftFinish® slimVario® electric		

Fabricado de acuerdo con IEC 60900.

Juego de adaptadores de par de apriete easy-Torque electric



para slimBits y soporte slimVario®, de 5 unid., en blíster

29701S5

n° pdo.		€/unid.
41479	5	197,09
1 x 0.8 Nm / 1 x 2.0 Nm / 1 x 2.5 Nm / 1 x 2.8 Nm / 1 x 4.0 Nm		

Fabricado de acuerdo con IEC 60900.

Adaptador de par de apriete easyTorque electric



para slimBits y soporte slimVario® en blíster

2970

n° pdo.	Nm		mm			€/unid.
41341	0.8	10 %	59	5.5	5	43,80
41342	2.0	10 %	59	5.5	5	43,80
41343	2.5	10 %	59	5.5	5	43,80
41344	2.8	10 %	59	5.5	5	43,80
41345	4.0	10 %	59	5.5	5	43,80

Fabricado de acuerdo con IEC 60900.

Juego de bits slimBit electric



en surtido con soporte slimBit de 7 unid.

2879B7

n° pdo.		€/unid.
36079	1	68,08
⊖	1 x Adaptador TorqueVario®-S electric para slimBits	
⊖	1 x 4.0 mm / 1 x 5.5 mm	
⊕	1 x PH1 / 1 x PH2	
⊕	1 x PZ1 / 1 x PZ2	

Fabricado de acuerdo con IEC 60900.

Adaptador TorqueVario®-S electric



para slimBits

28799

n° pdo.	⊖	⊕	mm	mm	€/unid.
35870	6.0	3.8	170	13	21,27

Fabricado de acuerdo con IEC 60900.

Adaptador TorqueVario®-S electric



para llaves de vaso de 1/4"

28799

n° pdo.	mm	mm	mm	€/unid.
43128	1/4"	3.8	178	21,27

Fabricado de acuerdo con IEC 60900.

Juego de bits slimBit electric



ranurados, de 7 unid., incl. caja de slimBits

SB2831B001

n° pdo.	€/unid.
43152	52,77
⊖	1 x 2.0 mm / 1 x 2.5 mm / 1 x 3.5 mm / 1 x 4.0 mm / 1 x 5.5 mm / 1 x 6.5 mm
	1 x Caja de slimBits

Probados en conformidad con la norma IEC 60900.

TORX®, de 7 unid., incl. caja de slimBits

SB2831B001

n° pdo.	€/unid.
43153	52,77
⊕	1 x T8 / 1 x T9 / 1 x T10 / 1 x T15 / 1 x T20 / 1 x T25
	1 x Caja de slimBits

Probados en conformidad con la norma IEC 60900.

TORX®, de 7 unid., incl. caja de slimBits

SB2831B502

n° pdo.	€/unid.
43154	52,77
⊕	1 x T6 / 1 x T7 / 1 x T8 / 1 x T9 / 1 x T10 / 1 x T15
	1 x Caja de slimBits

Probados en conformidad con la norma IEC 60900.

TORX PLUS®, de 7 unid., incl. caja de slimBits

SB2831B601

n° pdo.	€/unid.
43155	52,77
⊕	1 x 6IP / 1 x 7IP / 1 x 8IP / 1 x 9IP / 1 x 10IP / 1 x 15IP
	1 x Caja de slimBits

Probados en conformidad con la norma IEC 60900.



**hexagonales, de 7 unid., incl. caja de slimBits**

SB2831B801

n° pdo.		€/unid.
43156	1	52,77
1 x 2.0 mm / 1 x 2.5 mm / 1 x 3.0 mm / 1 x 4.0 mm / 1 x 5.0 mm / 1 x 6.0 mm 1 x Caja de slimBits		

Probados en conformidad con la norma IEC 60900.

**ranurados, Pozidriv, de 7 unid., incl. caja de slimBits**

SB2831B900

n° pdo.		€/unid.
43157	1	52,77
1 x 2.5 mm / 1 x 3.5 mm / 1 x 5.5 mm / 1 x 6.5 mm 1 x PZ1 / 1 x PZ2 1 x Caja de slimBits		

Probados en conformidad con la norma IEC 60900.

**ranurados, PlusMinus/Pozidriv, de 7 unid., incl. caja de slimBits**

SB2831B901

n° pdo.		€/unid.
43158	1	52,77
1 x 2.5 mm / 1 x 3.5 mm / 1 x 5.5 mm / 1 x 6.5 mm 1 x SL/PZ1 / 1 x SL/PZ2 1 x Caja de slimBits		

Probados en conformidad con la norma IEC 60900.

**ranurados, Phillips, de 7 unid., incl. caja de slimBits**

SB2831B902

n° pdo.		€/unid.
43159	1	52,77
1 x 2.5 mm / 1 x 3.5 mm / 1 x 5.5 mm / 1 x 6.5 mm 1 x PH1 / 1 x PH2 1 x Caja de slimBits		

Probados en conformidad con la norma IEC 60900.

**ranurados, Phillips, Pozidriv, de 7 unid., incl. caja de slimBits**

SB2831B903

n° pdo.		€/unid.
43160	1	52,77
1 x 2.0 mm / 1 x 2.5 mm 1 x PH0 / 1 x PH1 1 x PZ0 / 1 x PZ1 1 x Caja de slimBits		

Probados en conformidad con la norma IEC 60900.

**Juego de bits slimBit electric**



**TORX®, TORX PLUS®, de 15 unid., incl. cajas de slimBits y clip**

SB2831B950

n° pdo.		€/unid.
43161	1	105,54
1 x 6IP / 1 x 7IP / 1 x 8IP / 1 x 9IP / 1 x 10IP / 1 x 15IP 1 x T6 / 1 x T7 / 1 x T8 / 1 x T9 / 1 x T10 / 1 x T15 2 x Caja de slimBits 1 x Clip para el cinturón para caja de slimBits		

Probados en conformidad con la norma IEC 60900.

**ranurados, Phillips, Pozidriv, PlusMinus/Pozidriv, TORX®, de 15 unid., incl. cajas de slimBits y clip**

SB2831B951

n° pdo.		€/unid.
43162	1	105,54
1 x 3.5 mm / 1 x 5.5 mm 1 x PH1 / 1 x PH2 1 x PZ1 / 1 x PZ2 1 x SL/PZ1 / 1 x SL/PZ2 1 x T10 / 1 x T15 / 1 x T20 / 1 x T25 1 x Caja de slimBits		

Probados en conformidad con la norma IEC 60900.

## Bit slimBit electric



### Ranurado

283110

n° pdo.		mm		max. Nm		€/unid.
43114	1.5•	75	0.4	0.2	5	8,79
43115	2.0•	75	0.4	0.4	5	8,79
34578	2.5•	75	0.4	0.4	5	8,79
34579	3.0•	75	0.5	0.6	5	8,79
41159	3.5	75	0.6	1.4	5	8,79
44385	3.5	75	0.6	1.4	5	8,79
34580	4.0	75	0.8	2.5	5	8,79
34581	5.5	75	1.0	3.8	5	8,79
34582	6.5	75	1.2	5.5	5	8,79

•sin versión slim  
Fabricado de acuerdo con IEC 60900.

### Phillips

283111

n° pdo.		mm	max. Nm		€/unid.
43116	PH0•	75	0.9	5	8,79
34583	PH1	75	3.8	5	8,79
34584	PH2	75	5.5	5	8,79

•no versión slim  
Fabricado de acuerdo con IEC 60900.

### Pozidriv

283112

n° pdo.		mm	max. Nm		€/unid.
43117	PZO•	75	0.9	5	8,79
34585	PZ1	75	3.8	5	8,79
34586	PZ2	75	5.5	5	8,79

•no versión slim  
Fabricado de acuerdo con IEC 60900.

### PlusMinus/Phillips

283113

n° pdo.		mm	max. Nm		€/unid.
34587	SL/PH1	75	3.8	5	8,79
34588	SL/PH2	75	5.5	5	8,79

Fabricado de acuerdo con IEC 60900.

### PlusMinus/Pozidriv

283114

n° pdo.		mm	max. Nm		€/unid.
34589	SL/PZ1	75	3.8	5	8,79
34590	SL/PZ2	75	5.5	5	8,79

Fabricado de acuerdo con IEC 60900.

## TORX®

283115

n° pdo.		mm	max. Nm		€/unid.
43140	T5•	75	0.4	5	8,79
43141	T6•	75	0.6	5	8,79
43142	T7•	75	0.9	5	8,79
35506	T8•	75	1.3	5	8,79
41160	T9•	75	2.5	5	8,79
35507	T10•	75	3.8	5	8,79
35508	T15	75	5.0	5	8,79
35509	T20	75	5.5	5	8,79
36071	T25	75	5.5	5	8,79

•sin versión slim  
Fabricado de acuerdo con IEC 60900.

## TORX PLUS®

283116

n° pdo.		mm	max. Nm		€/unid.
43143	5IP•	75	0.5	5	8,79
43144	6IP•	75	0.8	5	8,79
43145	7IP•	75	1.3	5	8,79
43146	8IP•	75	2.0	5	8,79
43147	9IP•	75	3.0	5	8,79
43148	10IP•	75	4.5	5	8,79
43149	15IP••	75	5.5	5	8,79
43150	20IP••	75	5.5	5	8,79
43151	25IP••	75	5.5	5	8,79

•sin versión slim  
••no versión slim  
Fabricado de acuerdo con IEC 60900.

## hexagonal

283118

n° pdo.		mm	max. Nm		€/unid.
37222	1.5•	75	0.9	5	8,79
37223	2.0•	75	1.8	5	8,79
37224	2.5••	75	3.8	5	8,79
37147	3.0••	75	5.5	5	8,79
37225	4.0••	75	5.5	5	8,79
37226	5.0••	75	5.5	5	8,79
37227	6.0••	75	5.5	5	8,79

•sin versión slim  
••no versión slim  
Fabricado de acuerdo con IEC 60900.

## cuadrado

283117

n° pdo.			mm	max. Nm		€/unid.
35510	#1		75	5.5	5	8,79
35511	#2		75	5.5	5	8,79

Fabricado de acuerdo con IEC 60900.

## Destornillador dinámico con mango corredizo TorqueVario®-S T electric



5-14 Nm con limitación del par de apriete de ajuste variable

2933

n° pdo.	Nm	±%	Ø	L	W	H	€/unid.
43177	5 - 14	6 %	6.0	56	120	1	247,68

### CUADRO INFORMATIVO: Mango corredizo dinámico TorqueVario®-S TR electric



#### Mango corredizo dinámico TorqueVario®-S TR electric

- Para el atornillado controlado en un ámbito de aplicación amplio.
- El valor dinámico se puede ajustar de forma continua gradualmente con la herramienta de ajuste para mangos corredizos.
- Más fuerza para el atornillado gracias a la forma del mango.
- Cada herramienta ha sido probada individualmente a 10.000 V CA y ha sido autorizada para 1.000 V CA.
- Prueba de unidades individuales registradas directamente después de la producción en la fábrica.



## Varilla intercambiable electric



### TORX® para destornillador dinámico con mango corredizo electric

283795

n° pdo.	Ø	mm	W	max. Nm	H	€/unid.
38931	T15	136	35	5.5	10	13,76
38932	T20	136	35	10.0	10	13,76
38933	T25	136	35	15.0	10	13,76
38934	T27	136	35	15.0	10	13,76
38935	T30	136	35	20.0	10	13,76
38936	T40	136	35	20.0	10	13,76

Fabricado de acuerdo con IEC 60900.

## Varilla intercambiable electric



### hexagonal para destornillador dinámico con mango corredizo electric

283793

n° pdo.	Ø	mm	W	max. Nm	H	€/unid.
38918	3.0	136	35	5.5	10	13,76
38919	4.0	136	35	15.0	10	13,76
38920	5.0	136	35	20.0	10	13,76
38921	6.0	136	35	20.0	10	13,76

Fabricado de acuerdo con IEC 60900.

## Varilla intercambiable electric



### con llave de vaso hexagonal para destornillador dinámico con mango corredizo electric

283794

n° pdo.	Ø	mm	max. Nm	H	€/unid.
38925	7.0	136	5.0	10	16,51
38926	8.0	136	10.0	10	16,51
38927	9.0	136	14.0	10	16,51
38928	10.0	136	17.0	10	16,51
38929	13.0	136	20.0	10	16,51
38930	17.0	136	20.0	10	16,51

Fabricado de acuerdo con IEC 60900.

### Adaptador de mango corredizo TorqueVario®-S T electric



para llaves de vaso de 1/4"

283799

n° pdo.				€/unid.
43634	1/4"	88	10	26,86

### Herramienta de ajuste



para destornillador dinámico con mango en T

2899

n° pdo.				€/unid.
28691	90	146	10	14,51

### Llave dinométrica electric



de para llaves de vaso, con limitación del par de apriete de ajuste variable

2822

n° pdo.		Nm	in lbs					€/unid.
43126	1/4"	5 - 25	44.25 - 221.27	4 %	38	36	288 200	1 483,75
44163	3/8"	5 - 25	44.25 - 221.27	4 %	38	36	290 200	1 483,75

### Adaptador cuadrado aislado



3/8" para llave de vaso de 1/4"

283799

n° pdo.				€/unid.
44355	1/4"	100	1	32,14

### Destornillador dinámico iTorque®



con escala digital

28352

n° pdo.	Nm	in lbs	in oz					€/unid.
36886	0.4 - 1.5		60 - 210	6 %	4.0	134	34 1	219,86
36887	0.8 - 3		7 - 26	6 %	4.0	134	34 1	219,86
36888	1 - 5		9 - 44	6 %	4.0	134	40 1	226,15

DIN EN ISO 6789.

## CUADRO INFORMATIVO: iTorque

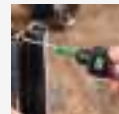
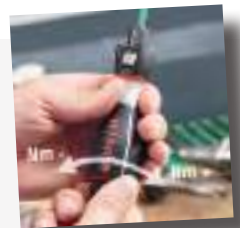

#### La herramienta dinométrica inteligente.

- El par de apriete deseado se puede ajustar en el extremo del mango sin necesidad de utilizar una herramienta adicional.
- La pantalla grande con indicación numérica facilita la lectura.
- La función ClickControl cuenta cada aplicación y optimiza la supervisión de medios de ensayo.
- Alarma de calibrado tras 5.000 aplicaciones para una seguridad absoluta del proceso.
- Prueba de unidades individuales registradas directamente después de la producción en la fábrica.
- Gran selección de varillas intercambiables y de varillas adaptadoras.
- Unidades convertibles (Nm in.lb/ cNm in.oz)
- Recalibrable

**Juego de destornilladores dinamoétricos TorqueVario®-S**



**0,8-5,0 Nm en surtido, de 14 unid., con limitación del par de apriete de ajuste variable de incl. caja** 2852S10

n° pdo.		€/unid.
26893	1	187,79
	1 x Destornillador dinamoétrico TorqueVario®-S con limitación del par de apriete de ajuste variable	
	1 x Portabits con fijación mediante bola para destornillador dinamoétrico con mango largo	
	1 x Herramienta de ajuste para destornillador dinamoétrico con mango largo	
	1 x PH1 / 1 x PH2	
	1 x PZ1 / 1 x PZ2	
	1 x T10 / 1 x T15 / 1 x T20 / 1 x T25	
	1 x 3.0 mm / 1 x 4.0 mm	
	1 x Caja	

DIN EN ISO 6789.

**0,8-5,0 Nm TORX®, TORX PLUS®, de 14 unid., con limitación del par de apriete de ajuste variable de incl. caja** 2852S1001

n° pdo.		€/unid.
34614	1	187,79
	1 x Destornillador dinamoétrico TorqueVario®-S con limitación del par de apriete de ajuste variable	
	1 x Portabits con fijación mediante bola para destornillador dinamoétrico con mango largo	
	1 x Herramienta de ajuste para destornillador dinamoétrico con mango largo	
	1 x T7 / 1 x T8 / 1 x T9 / 1 x T10 / 1 x T15	
	1 x 7IP / 1 x 8IP / 1 x 9IP / 1 x 10IP / 1 x 15IP	
	1 x Caja	

DIN EN ISO 6789.



## Destornillador dinámico TorqueVario®-S



### con limitación del par de apriete de ajuste variable

2852

n° pdo.	Nm	FA%	Ø	↔	⚙	📦	€/unid.
36849	0.04 - 0.46	10 %	4.0	127	23	1	132,18
36850	0.1 - 0.6	6 %	4.0	127	23	1	179,37
26888	0.1 - 0.6	10 %	4.0	127	23	1	132,18
26461	0.4 - 1	6 %	4.0	127	23	1	132,18
26462	0.5 - 2	6 %	4.0	131	30	1	146,79
26463	0.8 - 5	6 %	4.0	138	36	1	150,63
26464	2 - 7	6 %	4.0	142	41	1	162,02

•Precisión en un rango de 0,1-0,46 Nm.  
DIN EN ISO 6789.

## Destornillador dinámico TorqueFix®



### con limitación del par de apriete preajustada de forma fija

2850

n° pdo.	Nm	FA%	Ø	↔	⚙	📦	€/unid.
26925	0.4	6 %	4.0	112	23	1	108,61
26127	0.5	6 %	4.0	112	23	1	108,61
26047	0.6	6 %	4.0	112	23	1	108,61
26327	0.8	6 %	4.0	112	23	1	108,61
26048	0.9	6 %	4.0	112	23	1	108,61
26133	1.1	6 %	4.0	119	30	1	117,43
26049	1.2	6 %	4.0	119	30	1	117,43
26901	1.5	6 %	4.0	119	30	1	117,43
26051	2.0	6 %	4.0	119	30	1	117,43
26128	2.5	6 %	4.0	119	36	1	117,43
26052	3.0	6 %	4.0	126	36	1	126,09
26129	3.8	6 %	4.0	126	36	1	126,09
26053	5.0	6 %	4.0	132	41	1	134,43
26130	5.5	6 %	4.0	132	41	1	134,43
34533	6.0	6 %	4.0	132	41	1	134,43
26131	7.2	6 %	4.0	132	41	1	134,43

DIN EN ISO 6789.

## CUADRO INFORMATIVO: TorqueVario®-S

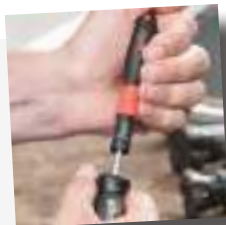

### Herramientas dinámicas de ajuste variable

- Para el atornillado controlado en un ámbito de aplicación amplio.
- El valor dinámico se puede ajustar gradualmente con la herramienta de ajuste Torque-Setter.
- Sonido de clic claramente audible y sensible al alcanzar el valor dinámico ajustado.
- Cada mango de destornillador de Wiha ofrece una relación entre el guiado, la velocidad y el par de apriete, adaptada de manera óptima a la tarea de atornillado.
- Prueba de unidades individuales registradas directamente después de la producción en la fábrica.
- Gran selección de varillas intercambiables y de varillas adaptadoras.

## CUADRO INFORMATIVO: TorqueFix®

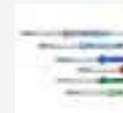

### Herramientas dinámicas preajustadas de forma fija

- 
- Sonido de clic claramente audible y sensible al alcanzar el valor dinámico ajustado.
- Cada mango de destornillador de Wiha ofrece una relación entre el guiado, la velocidad y el par de apriete, adaptada de manera óptima a la tarea de atornillado.
- Gran selección de varillas intercambiables y de varillas adaptadoras.

## Juego de destornilladores dinamométricos TorqueFix®



con llave de cables para conector redondo, de 2  
unid., con limitación del par de apriete  
preajustada de forma fija

2850

n° pdo.	Nm							€/unid.
36846	0.4	9	230	78	112	23	1	138,65
36847	0.6	13	230	78	112	23	1	138,65

DIN EN ISO 6789.

## Destornillador dinamométrico easyTorque



con limitación del par de apriete preajustada de  
forma fija

2920

n° pdo.	Nm							€/unid.
36229	0.5	10 %	4.0	130	34	1	47,64	
36230	0.6	10 %	4.0	130	34	1	47,64	
36240	0.9	10 %	4.0	130	34	1	47,64	
36231	1.1	10 %	4.0	130	34	1	47,64	
36233	1.2	10 %	4.0	130	34	1	47,64	
36234	1.4	10 %	4.0	130	34	1	47,64	
36235	2.0	10 %	4.0	130	34	1	49,78	
36236	2.5	10 %	4.0	130	34	1	49,78	
36237	3.0	10 %	4.0	130	34	1	49,78	
36238	3.8	10 %	4.0	130	34	1	49,78	
36320	4.0	10 %	4.0	130	34	1	51,01	
36321	4.5	10 %	4.0	130	34	1	51,01	
36239	5.0	10 %	4.0	130	34	1	51,01	

**varilla intercambiable**



**ranurada para destornillador dinámico con mango largo**

28590

n° pdo.								€/unid.
26227	0.3	1.5	4	175	42	0.2	10	6,47
26228	0.4	2.0	4	175	42	0.4	10	6,47
26151	0.4	2.5	4	175	42	0.4	10	6,47
26277	0.5	3.0	4	175	42	0.6	10	6,47
26278	0.6	3.5	4	175	42	1.1	10	6,47
26279	0.8	4.0	4	175	42	2.5	10	6,47

**Phillips para destornillador dinámico con mango largo**

28591

n° pdo.								€/unid.
26199	PH000	4	175	42	0.4	10	6,47	
26196	PH00	4	175	42	0.4	10	6,47	
26197	PH0	4	175	42	0.9	10	6,47	
26058	PH1	4	175	42	3.8	10	6,47	
27079	PH2	4	175	42	5.5	10	6,47	

**Pozidriv para destornillador dinámico con mango largo**

28592

n° pdo.								€/unid.
26198	PZ0	4	175	42	0.9	10	6,47	
26148	PZ1	4	175	42	3.8	10	6,47	
26889	PZ2	4	175	42	5.5	10	6,47	

**TORX® MagicSpring® para destornillador dinámico con mango largo**

28595R

n° pdo.								€/unid.
27818	T6	4	175	42	0.6	10	8,35	
27812	T7	4	175	42	0.9	10	8,35	
27813	T8	4	175	42	1.3	10	8,35	
27814	T9	4	175	42	2.5	10	8,35	
27815	T10	4	175	42	3.8	10	8,35	
27816	T15	4	175	42	5.5	10	8,35	
27817	T20	4	175	42	8.0	10	8,35	
29467	T25	4	175	42	8.0	10	8,35	

**TORX® para destornillador dinámico con mango largo**

28595

n° pdo.								€/unid.
30852	T4	4	175	42	0.3	10	6,47	
26158	T5	4	175	42	0.4	10	6,47	
26064	T6	4	175	42	0.6	10	6,47	
26065	T7	4	175	42	0.9	10	6,47	
26066	T8	4	175	42	1.3	10	6,47	
26059	T9	4	175	42	2.5	10	6,47	
26067	T10	4	175	42	3.8	10	6,47	
26068	T15	4	175	42	5.5	10	6,47	
26069	T20	4	175	42	8.0	10	6,47	
26070	T25	4	175	42	8.0	10	6,47	

**TORX PLUS® MagicSpring® para destornillador dinámico con mango largo**

28596R

n° pdo.								€/unid.
29553	6IP	4	175	42	0.8	10	8,48	
29554	7IP	4	175	42	1.3	10	8,48	
29555	8IP	4	175	42	2.0	10	8,48	
29556	9IP	4	175	42	3.0	10	8,48	
29557	10IP	4	175	42	4.5	10	8,48	
29558	15IP	4	175	42	6.6	10	8,48	
29559	20IP	4	175	42	8.0	10	8,48	
29560	25IP	4	175	42	8.0	10	8,48	

**TORX PLUS® para destornillador dinámico con mango largo**

28596

n° pdo.								€/unid.
26159	5IP	4	175	42	0.5	10	6,60	
26071	6IP	4	175	42	0.8	10	6,60	
26152	7IP	4	175	42	1.3	10	6,60	
26072	8IP	4	175	42	2.0	10	6,60	
26154	9IP	4	175	42	3.0	10	6,60	
26155	10IP	4	175	42	4.5	10	6,60	
26073	15IP	4	175	42	6.6	10	6,60	
26156	20IP	4	175	42	8.0	10	6,60	
26157	25IP	4	175	42	8.0	10	6,60	

**con cabeza esférica hexagonal para destornillador dinámico con mango largo**

28597

n° pdo.								€/unid.
26221	1.5	4	175	42	0.4	10	6,47	
26222	2.0	4	175	42	0.9	10	6,47	
26223	2.5	4	175	42	2.0	10	6,47	
26224	3.0	4	175	42	3.8	10	6,47	
26225	4.0	4	175	42	8.0	10	6,47	

**hexagonal para destornillador dinámico con mango largo**

28593

n° pdo.								€/unid.
26544	1.3	4	175	42	0.4	10	6,47	
26200	1.5	4	175	42	0.9	10	6,47	
26060	2.0	4	175	42	1.8	10	6,47	
26061	2.5	4	175	42	3.8	10	6,47	
26062	3.0	4	175	42	5.5	10	6,47	
26063	4.0	4	175	42	8.0	10	6,47	



### Llave de cables para conector redondo



### Hexágono exterior para destornillador dinámico con mango largo

28594

n° pdo.							€/unid.
36414	8	4	78	218	1.0	10	32,56
36415	9	4	78	218	1.0	10	32,56
36417	13	4	78	218	1.5	10	34,06
36418	14	4	78	218	1.5	10	34,06
36421	18	4	78	218	1.5	5	36,14

### varilla intercambiable



### con cuadrado de 1/4" para destornillador dinámico con mango largo

28599

n° pdo.					€/unid.
26229	1/4"	4"	155	10	10,05

### Portabits con fijación mediante bola



### para destornillador dinámico con mango largo

28599

n° pdo.						€/unid.
27526	1/4"	4	162	11	10	17,87

### Herramienta de ajuste



### para destornillador dinámico con mango largo

2859

n° pdo.				€/unid.
26864	90	146	1	14,23

### CUADRO INFORMATIVO: MagicSpring®



#### MagicSpring® TORX® de Wiha

- El resorte de acero inoxidable sujeta los tornillos TORX® o TORX PLUS® de un modo seguro.
- Una innovación que convencerá a cualquier usuario.

### CUADRO INFORMATIVO: con cabeza esférica hexagonal

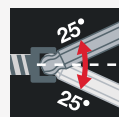

#### Cabeza esférica hexagonal de Wiha

- La punta de bola se puede girar un máximo de 25° a izquierda y derecha.

**Juego de destornilladores dinamoétricos con mango en T TorqueVario®-ST**



**5-14 Nm en surtido de 12 unid. con limitación del par de apriete de ajuste variable de incl. caja** 2893S01

n° pdo.	📦	€/unid.
29234	1	315,52

- 1 x Destornillador dinamoétrico con mango en T TorqueVario®-S T 5-14 Nm con limitación del par de apriete de ajuste variable
- 1 x Herramienta de ajuste para destornillador dinamoétrico con mango en T
- 1 x Varilla adaptadora para destornillador dinamoétrico con mango en T / 1 x Varilla adaptadora para destornillador dinamoétrico con mango en T
- 1 x Portabits para destornillador dinamoétrico con mango en T
- ⊕ 1 x T25 / 1 x T30 / 1 x T40
- 1 x 4.0 mm / 1 x 5.0 mm / 1 x 6.0 mm
- 1 x Caja

DIN EN ISO 6789.

**Destornillador dinamoétrico con mango en T TorqueVario®-S T**



**5-14 Nm con limitación del par de apriete de ajuste variab** 2893

n° pdo.	Nm	VA%	⊕	⊖	—	📦	€/unid.
29233	5 - 14	6	6.0	56	120	1	242,99

DIN EN ISO 6789.

**Destornillador dinamoétrico con mango corredizo TorqueFix® T**



**con limitación del par de apriete preajustada de forma fija** 2891

n° pdo.	Nm	VA%	⊕	⊖	—	📦	€/unid.
29228	6.0	6	6.0	56	120	1	214,70
29229	8.0	6	6.0	56	120	1	214,70
29230	10.0	6	6.0	56	120	1	214,70
29231	12.0	6	6.0	56	120	1	214,70
29236	12.5	6	6.0	56	120	1	214,70
29232	14.0	6	6.0	56	120	1	214,70

DIN EN ISO 6789.

### varilla intercambiable



#### TORX® para destornillador dinámico con mango corredizo

28995

n° pdo.		mm	mm		max Nm		€/unid.
28734	T15	6	130	53	5.5	10	9,43
28735	T20	6	130	53	10.0	10	9,43
28736	T25	6	130	53	15.0	10	9,43
28737	T27	6	130	53	15.0	10	9,43
28738	T30	6	130	53	20.0	10	9,43
28739	T40	6	130	53	20.0	10	9,43

#### TORX PLUS® para destornillador dinámico con mango corredizo

28996

n° pdo.		mm	mm		max Nm		€/unid.
28740	15IP	6	130	53	6.6	10	9,43
28741	20IP	6	130	53	13.0	10	9,43
28742	25IP	6	130	53	15.0	10	9,43
28743	27IP	6	130	53	15.0	10	9,43
28744	30IP	6	130	53	20.0	10	9,43
28745	40IP	6	130	53	20.0	10	9,43

#### hexagonal para destornillador dinámico con mango corredizo

28993

n° pdo.		mm	mm		max Nm		€/unid.
28746	3.0	6	130	53	5.5	10	9,43
28747	4.0	6	130	53	15.0	10	9,43
28748	5.0	6	130	53	20.0	10	9,43
28749	6.0	6	130	53	20.0	10	9,43

### Varilla adaptadora



#### para destornillador dinámico con mango en T

28999

n° pdo.		mm	mm			€/unid.
28756	1/4"	6	120	53	10	18,29
28757	3/8"	6	120	53	10	18,29

### Portabits



#### para destornillador dinámico con mango en T

28999

n° pdo.		mm	mm			€/unid.
28758	1/4"	6	125	11	10	28,15

### Herramienta de ajuste



#### para destornillador dinámico con mango en T

28999

n° pdo.		mm		€/unid.
28691	90	146	10	14,51

**Destornillador dinámico con mango de llave TorqueFix® Key**



**con limitación del par de apriete preajustada de forma fija**

28360

n° pdo.	Nm	FA%	Ø	L	l	⊞	€/unid.
38616	0.5	6	4.0	68	50	1	69,04
38617	0.6	6	4.0	68	50	1	69,04
38618	0.9	6	4.0	68	50	1	69,04
38556	1.1	6	4.0	68	50	1	69,04
38800	1.2	6	4.0	68	50	1	69,04
38619	1.4	6	4.0	68	50	1	69,04
38557	2.0	6	4.0	68	50	1	69,04
38620	2.5	6	4.0	68	50	1	69,04
38621	3.0	6	4.0	68	50	1	69,04
38558	3.8	6	4.0	68	50	1	69,04
38622	4.0	6	4.0	68	50	1	69,39

DIN EN ISO 6789.

**varilla intercambiable**



**hexagonal para destornillador dinámico con mango de llave**

283693

n° pdo.	Ø	Ø mir	mm	l	max Nm	⊞	€/unid.
38801	1.5	4	75	20	0.9	10	5,91
38802	2.0	4	75	20	1.8	10	5,91
38803	2.5	4	75	20	3.8	10	5,91
38804	3.0	4	75	20	5.5	10	5,91
38805	4.0	4	75	20	8.0	10	5,91

**varilla intercambiable**



**TORX® para destornillador dinámico con mango de llave**

283695

n° pdo.	Ø	Ø mir	mm	l	max Nm	⊞	€/unid.
38806	T6	4	75	20	0.6	10	5,91
38807	T7	4	75	20	0.9	10	5,91
38808	T8	4	75	20	1.3	10	5,91
38809	T9	4	75	20	2.5	10	5,91
38810	T10	4	75	20	3.8	10	5,91
38811	T15	4	75	20	5.5	10	5,91
38812	T20	4	75	20	8.0	10	5,91
38813	T25	4	75	20	8.0	10	5,91

**varilla intercambiable**



**TORX PLUS® para destornillador dinámico con mango de llave**

283696

n° pdo.	Ø	Ø mir	mm	l	max Nm	⊞	€/unid.
38814	6IP	4	75	20	0.8	10	5,91
38815	7IP	4	75	20	1.3	10	5,91
38816	8IP	4	75	20	2.0	10	5,91
38817	9IP	4	75	20	3.0	10	5,91
38818	10IP	4	75	20	4.5	10	5,91
38819	15IP	4	75	20	6.6	10	5,91
38820	20IP	4	75	20	8.0	10	5,91
38821	25IP	4	75	20	8.0	10	5,91

**Juego de destornilladores dinamométricos TorqueVario®-S ESD**



**0,4-1,0 Nm en surtido, de 14 unid., con limitación del par de apriete de ajuste variable, incl. caja**

2882S13

n° pdo.		€/unid.
43898	1	219,57
○	1 x Destornillador dinamométrico TorqueVario®-S ESD con limitación del par de apriete de ajuste variable	
○	1 x Portabits con fijación mediante bola para destornillador dinamométrico con mango largo	
	1 x Herramienta de ajuste para destornillador dinamométrico con mango largo	
⊕	1 x PH0 / 1 x PH1	
⊕	1 x PZ0 / 1 x PZ1	
⊕	1 x T4 / 1 x T5 / 1 x T6 / 1 x T8	
	1 x Caja	

DIN EN ISO 6789.  
IEC 61340-5-1.

**Destornillador dinamométrico TorqueVario®-S ESD**



**con limitación del par de apriete de ajuste variable**

2882

n° pdo.	Nm	±%	⊕	⊖	⊕	⊖	€/unid.
36851	0.04 - 0.46	10 %	4.0	127	23	1	169,67
26865	0.1 - 0.6	10 %	4.0	127	23	1	169,67
36852	0.1 - 0.6	6 %	4.0	127	23	1	221,57
26629	0.4 - 1	6 %	4.0	127	23	1	169,67
26866	0.5 - 2	6 %	4.0	131	30	1	188,77
30495	0.8 - 5	6 %	4.0	138	36	1	197,08





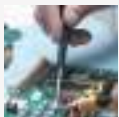







• Precisión en un rango de 0,1-0,46 Nm.  
IEC 61340-5-1. DIN EN ISO 6789.

**CUADRO INFORMATIVO:  
Herramientas con derivación electrostática ESD**



- Las herramientas disipadoras de Wiha derivan la energía eléctrica de forma controlada y segura.
- Las herramientas ESD cumplen la norma ESD IEC 61340-5-1.
- Los mangos de las herramientas ESD tienen una resistencia superficial de 10<sup>6</sup> - 10<sup>9</sup> ohmios.

# Vista general de herramientas dinamométricas

Herramientas	Precisión	Ajuste	Particularidad	Rango Nm	Rango dinamométrico				
					0,01 Nm	0,1 Nm	1 Nm	10 Nm	20 Nm
<b>iTorque</b> 	± 6 %	variable	Pantalla digital ClickControl Alarma de calibrado Escala numérica	0,4 – 1,5 0,8 – 3,0 1,0 – 5,0					
<b>TorqueVario®-S</b> 	± 10 % ± 6 %/± 10 % ± 6 %	variable	Escala numérica	0,04 – 0,46 0,1 – 0,6 0,4 – 1,0 0,5 – 2,0 0,8 – 5,0 2,0 – 7,0					
<b>TorqueVario®-S ESD</b> 	± 10 % ± 6 %/± 10 % ± 6 %	variable	Compatible con ESD Escala numérica	0,04 – 0,46 0,1 – 0,6 0,4 – 1,0 0,5 – 2,0 0,8 – 5,0					
<b>TorqueFix®</b> 	± 6 %	ajuste fijo	Preajustado fijamente en fábrica	16 Versiones 0,4 – 7,2					
<b>easyTorque</b> 	± 10 %	ajuste fijo	Preajustado fijamente en fábrica	13 Versiones 0,5 – 5,0					
<b>TorqueFix® Key</b> 	± 6 %	ajuste fijo	Preajustado fijamente en fábrica	0,5 – 4,0					
<b>Adaptador easyTorque</b> 	± 10 %	ajuste fijo	Certificado VDE Preajustado fijamente en fábrica	5 Versiones 0,8 – 4,0					
<b>TorqueVario®-S VDE</b> 	± 6 %	variable	Certificado VDE Escala numérica	0,5 – 2,0 0,8 – 5,0 2,0 – 7,0					
<b>TorqueVario®-S T electric</b> 		variable	Certificado VDE Escala numérica	5 – 14					
<b>Llave dinamométrica electric</b> 	± 4 %	variable	Certificado VDE Escala numérica	5-25					
<b>TorqueVario®-S T</b> 	± 6 %	variable	Escala numérica	5,0 – 14					
<b>TorqueFix®-T</b> 	± 6 %	ajuste fijo	Preajustado fijamente en fábrica	6 Versiones 6,0 – 14					

Varillas intercambiables

Serie 2859

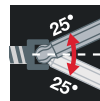

Serie 28369

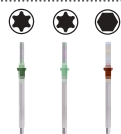

slimBits  
Serie 2831

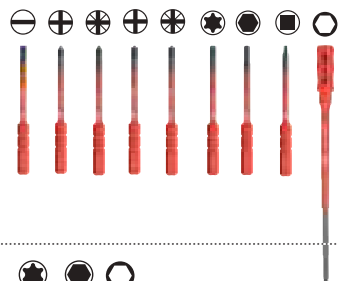

Serie 28379



Serie 7207 (3/8")  
Serie 7209 (1/4")



Serie 2899





## **Herramientas multiusos**

### **Muchos funciones en un espacio mínimo.**

Menos herramientas significan menos carga, mejor manejo y trabajo eficiente. Cuantas más funciones tenga una herramienta, mejor: Las herramientas multiusos de Wiha son herramientas compactas y con una aplicación versátil, que ahorran espacio y peso y que demuestran ser el acompañante perfecto especialmente en el uso móvil.

En el portabits con cargador LiftUp de Wiha, los bits más utilizados están alojados de manera compacta en el mango, siempre están disponibles y son fáciles de manejar. El sistema de varillas reversibles de Wiha ofrece una gran variedad de varillas intercambiables, cuyas longitudes se pueden ajustar de forma variable. Los PocketStars pequeños y compactos de Wiha incluyen las llaves más utilizadas, ayudantes indispensables en cualquier equipamiento. El portabits con cargador Stubby de Wiha, reúne al mismo tiempo seis formas de accionamiento en una y permite un acceso sin ningún tipo de obstáculos a cualquier lugar estrecho gracias a su mango de destornillador extremadamente corto.



Herramientas All in One

**Destornillador con cargador LiftUp electric Ranurado, Phillips con 6 slimBits, en blíster**  
Página 186



**Destornillador con cargador LiftUp 26one® en surtido con 13 bits dobles 1/4", en blíster**  
Página 187



**Destornillador con cargador Stubby en surtido con 7 bits dobles**  
Página 187



**Juego de bits de bit doble ranurado, de 10 unid., en caja**  
Página 188



**Herramienta multiusos PocketStar en surtido de 9 unid.**  
Página 190



**Herramienta multiusos PocketStar TORX®, de 8 unid.**  
Página 190



**Herramienta multiusos PocketStar con cabeza esférica hexagonal MagicRing®, de 7 unid.**  
Página 192



**Llave para armarios de distribución en forma de espiga en blíster**  
Página 194



**Inserto de llave de vaso Gripper de 3/8", en blíster**  
Página 194



Juegos de varillas intercambiables

**Juego de destornilladores con varillas intercambiables SYSTEM 6 en surtido, de 12 unid., incl. caja**  
Página 195



**Juego de destornilladores con varillas intercambiables SYSTEM 4 ESD, en surtido de 12 unid incl. bolsa enrollable**  
Página 202



**Juego de destornilladores con varillas intercambiables SYSTEM 6 ESD en surtido, de 7 unid., incl. bolsa enrollable**  
Página 197



**Juego de destornilladores con varillas intercambiables SYSTEM 4 en surtido de 12 unid incl. bolsa enrollable**  
Página 200





**ranurado, Phillips, con 6 slimBits** 283109020

n° pdo.			€/unid.
38610		5	76,70
38612	x	5	77,85
⊖	1 x 2.5 mm / 1 x 3.0 mm / 1 x 4.0 mm / 1 x 5.5 mm		
⊕	1 x PH1 / 1 x PH2		

Fabricado de acuerdo con IEC 60900.

**TORX® con 6 slimBits** 283109022

n° pdo.			€/unid.
41157		5	76,70
41158	x	5	77,85
⊗	1 x T8 / 1 x T9 / 1 x T10 / 1 x T15 / 1 x T20 / 1 x T25		

Fabricado de acuerdo con IEC 60900.

**Phillips, PlusMinus/Pozidriv, ranurado con 6 slimBits** 283109021

n° pdo.			€/unid.
38611		5	76,70
38613	x	5	77,85
⊖	1 x 3.0 mm / 1 x 4.0 mm / 1 x 5.5 mm		
⊕	1 x PH1 / 1 x PH2		
⊗	1 x SL/PZ2		

Fabricado de acuerdo con IEC 60900.

**Pozidriv, PlusMinus/Pozidriv, ranurado con 6 slimBits** 283109023

n° pdo.			€/unid.
41234		5	76,70
41235	x	5	77,85
⊖	1 x 2.5 mm / 1 x 3.5 mm / 1 x 5.5 mm		
⊗	1 x PZ1 / 1 x PZ2		
⊗	1 x SL/PZ2		

Fabricado de acuerdo con IEC 60900.

CUADRO INFORMATIVO:  
**slimTECHNOLOGY**



**Wiha SoftFinish electric slimFix**

- Accesibilidad sin obstáculos.
- Varillas hasta un 33 % más delgadas gracias al aislamiento integrado.
- Herramienta de accionamiento para grapas elásticas (geometría de accionamiento perfilada en forma de cuña).

### Destornillador con cargador LiftUp 26one®



en surtido con 13 bits dobles 1/4", en blíster		SB380304021	
n° pdo.		€/unid.	
43895	1	68,78	
	Punta doble, ranurado/ ranurado 4,0/6,0 / Bit doble, Ranurado/Ranurado 5,5/6,5		
	Bit doble, Phillips/Phillips PH0/PH3 / Bit doble, Phillips/Phillips PH1/PH2		
	Bit doble, TORX®/TORX® T6/T8 / Bit doble, TORX®/TORX® T10/T15 / Bit doble, TORX®/TORX® T20/T25 / Bit doble, TORX®/TORX® T27/T30		
	Bit doble, Pozidriv/Pozidriv PZ1/PZ2 / Bit doble, Pozidriv/Pozidriv PZ0/PZ3		
	Bit doble con hembra cuadrada/hembra cuadrada #1/#2		
	Bit doble hexagonal interior/hexagonal interior 3.0/4.0 / Bit doble hexagonal interior/hexagonal interior 5.0/6.0		

### Destornillador con cargador Stubby



en surtido con 7 bits dobles		SB380201	
n° pdo.		€/unid.	
43613	5	23,65	
	Punta doble, ranurado/ ranurado 1/4" 4.0/6.0		
	Bit doble, Phillips/Phillips PH1/PH2		
	Bit doble, Pozidriv/Pozidriv PZ1/PZ2		
	Bit doble hexagonal interior/hexagonal interior 3.0/4.0		
	Bit doble, TORX®/TORX® T10/T15		



### CUADRO INFORMATIVO: LiftUp 26one®

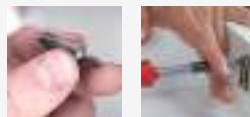

#### Todos los perfiles más utilizados en todo el mundo en una herramienta.

- 12 w magazynku i 1 bit podwójny w uchwycie na bity.
- El cargador se extrae pulsando un botón y libera los bits para su extracción.
- Acceso ilimitado a tornillos situados a mayor profundidad con el portabits SuperSlim con bloqueo automático.
- El atornillado o el desatornillado potente de tornillos. son posibles gracias al mango del destornillador de gran tamaño.



ranurado, de 10 unid., en caja		741094060030
n° pdo.	€/unid.	
43858	1	26,88
Punta doble, ranurado/ ranurado 1/4" 4.0/6.0		

hexagonal interior, de 10 unid., en caja		741390506030
n° pdo.	€/unid.	
43865	1	26,88
Bit doble hexagonal interior/hexagonal interior 5.0/6.0		

ranurado, de 10 unid., en caja		741095565030
n° pdo.	€/unid.	
43859	1	26,88
Bit doble, Ranurado/Ranurado 5,5/6,5		

TORX®, de 10 unid., en caja		741590608030
n° pdo.	€/unid.	
43866	1	26,88
Bit doble, TORX®/TORX® T6/T8		

Phillips, de 10 unid., en caja		741190003030
n° pdo.	€/unid.	
43860	1	26,88
Bit doble, Phillips/Phillips PH0/PH3		

TORX®, de 10 unid., en caja		741591015030
n° pdo.	€/unid.	
43867	1	26,88
Bit doble, TORX®/TORX® T10/T15		

Phillips, de 10 unid., en caja		741190102030
n° pdo.	€/unid.	
43861	1	26,88
Bit doble, Phillips/Phillips PH1/PH2		

TORX®, de 10 unid., en caja		741592025030
n° pdo.	€/unid.	
43868	1	26,88
Bit doble, TORX®/TORX® T20/T25		

Pozidriv, de 10 unid., en caja		741290003030
n° pdo.	€/unid.	
43862	1	26,88
Bit doble, Pozidriv/Pozidriv PZ0/PZ3		

TORX®, de 10 unid., en caja		741592730030
n° pdo.	€/unid.	
43869	1	26,88
Bit doble, TORX®/TORX® T27/T30		

Pozidriv, de 10 unid., en caja		741290102030
n° pdo.	€/unid.	
43863	1	26,88
Bit doble, Pozidriv/Pozidriv PZ1/PZ2		

Hembra cuadrada, de 10 unid., en caja		741990102030
n° pdo.	€/unid.	
43870	1	26,88
Bit doble con hembra cuadrada/hembra cuadrada #1/#2		

hexagonal interior, de 10 unid., en caja		741390304030
n° pdo.	€/unid.	
43864	1	26,88
Bit doble hexagonal interior/hexagonal interior 3.0/4.0		

### Destornillador con cargador LiftUp 25 magnético



#### en surtido con 12 bits, de 1/4"

380302020

n° pdo.			€/unid.
38600		5	41,69
38605	x	5	43,77
	1 x 4.5 mm / 1 x 6.5 mm		
	1 x PH1 / 1 x PH2 / 1 x PH3		
	1 x PZ1 / 1 x PZ2 / 1 x PZ3		
	1 x T15 / 1 x T20 / 1 x T25 / 1 x T30		

#### en surtido con 12 bits, de 1/4"

380302021

n° pdo.			€/unid.
38601		5	44,94
38606	x	5	46,90
	1 x 5.5 mm		
	1 x PH2		
	1 x PZ1 / 1 x PZ2 / 1 x PZ3		
	1 x T15 / 1 x T20 / 1 x T25 / 1 x T30		
	1 x 3.0 mm / 1 x 4.0 mm / 1 x 5.0 mm		

### Destornillador con cargador magnético



#### en surtido con 8 bits, de 1/4"

38090101

n° pdo.			€/unid.
32901		5	34,21
33007	x	5	35,45
	1 x 6.5 mm		
	1 x PH1 / 1 x PH2 / 1 x PH3		
	1 x PZ2		
	1 x T15 / 1 x T20 / 1 x T25		

#### TORX® con 8 bits, de 1/4"

38090102

n° pdo.			€/unid.
32902		5	36,71
33008	x	5	38,10
	1 x T6 / 1 x T8 / 1 x T10 / 1 x T15 / 1 x T20 / 1 x T25 / 1 x T30 / 1 x T40		

#### ranurado, Phillips con 8 bits, de 1/4"

38090103

n° pdo.			€/unid.
32903		5	32,56
33009	x	5	34,21
	1 x 5.5 mm / 1 x 6.5 mm		
	1 x PH1 / 3 x PH2 / 2 x PH3		

### Destornillador con cargador magnético



#### ranurado, Phillips con 6 bits, Stubby, de 1/4"

380101

n° pdo.			€/unid.
33736		10	17,09
33738	x	5	18,47
	4.5 mm / 6.5 mm / 8.0 mm		
	PH1 / PH2 / PH3		

#### Phillips, Pozidriv con 6 bits, Stubby, de 1/4"

380102

n° pdo.			€/unid.
33740		10	17,09
33741	x	5	18,47
	PH1 / PH2 / PH3		
	PZ1 / PZ2 / PZ3		

#### TORX® con 6 bits, Stubby, de 1/4"

380103

n° pdo.			€/unid.
33743		10	17,09
33744	x	5	18,47
	T10 / T15 / T20 / T25 / T30 / T40		

#### ranurado, Pozidriv con 6 bits, Stubby, de 1/4"

380104

n° pdo.			€/unid.
33764		10	17,09
33746	x	5	18,47
	4.5 mm / 6.5 mm / 8.0 mm		
	PZ1 / PZ2 / PZ3		

Herramienta multiusos PocketStar



en surtido de 9 unid.

351PG9X

n° pdo.			€/unid.
25293		5	31,15
25295	x	5	31,53
			Varilla Ranura 4,5
			Varilla Phillips PH2
			Varilla TORX® T10 / Varilla TORX® T15 / Varilla TORX® T20
			Varilla Hexágono interior 3 / Varilla Hexágono interior 4 / Varilla Hexágono interior 5 / Varilla Hexágono interior 6

Herramienta multiusos PocketStar



TORX®, de 8 unid.

363P8

n° pdo.			€/unid.
23047		5	32,41
23049	x	5	32,77
			Varilla TORX® T9 / Varilla TORX® T10 / Varilla TORX® T15 / Varilla TORX® T20 / Varilla TORX® T25 / Varilla TORX® T27 / Varilla TORX® T30 / Varilla TORX® T40

Herramienta multiusos Mini PocketStar



ranurada, Phillips, hexagonal interior, de 6 unid., en blister

SB351PM8X

n° pdo.			€/unid.
27936		5	27,90
			Varilla Hexágono interior 0,7 / Varilla Hexágono interior 0,9 / Varilla Hexágono interior 1,3 / Varilla Hexágono interior 1,5 / Varilla Hexágono interior 2
			Varilla Ranura 1,5 / Varilla Ranura 2
			Varilla Phillips PH00

Herramienta multiusos PocketStar



TORX®, de 7 unid.

363P7

n° pdo.			€/unid.
23051		5	29,77
23053	x	5	30,28
			Varilla TORX® T7 / Varilla TORX® T8 / Varilla TORX® T9 / Varilla TORX® T10 / Varilla TORX® T15 / Varilla TORX® T20 / Varilla TORX® T25



TORX® Tamper Resistant (con taladro), de 8 unid.			363TRP8
n° pdo.			€/unid.
25130		5	37,41
25166	x	5	37,79
TORX® Tamper Resistant Varilla T9H / TORX® Tamper Resistant Varilla T10H / TORX® Tamper Resistant Varilla T15H / TORX® Tamper Resistant Varilla T20H / TORX® Tamper Resistant Varilla T25H / TORX® Tamper Resistant Varilla T27H / TORX® Tamper Resistant Varilla T30H / TORX® Tamper Resistant Varilla T40H			



TORX® Tamper Resistant (con taladro), de 7 unid.			363TRP7
n° pdo.			€/unid.
25128		5	34,91
25164	x	5	35,28
TORX® Tamper Resistant Varilla T7H / TORX® Tamper Resistant Varilla T8H / TORX® Tamper Resistant Varilla T9H / TORX® Tamper Resistant Varilla T10H / TORX® Tamper Resistant Varilla T15H / TORX® Tamper Resistant Varilla T20H / TORX® Tamper Resistant Varilla T25H			

### CUADRO INFORMATIVO: PocketStar

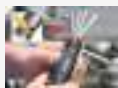

#### La herramienta multiusos en formato de bolsillo

- Selección sencilla del tamaño de llave deseado pulsando un botón.
- Se puede utilizar como destornillador con mango largo y como mango en T
- El tope de 270° para trabajos relevantes para la seguridad evita el aplastamiento de los dedos.
- Los extremos cubiertos de los dos ejes giratorios evitan que se enganche en las prendas de ropa.

### CUADRO INFORMATIVO: Juego Perfil de seguridad Tamper Resistant TORX®



- El perfil de seguridad se utiliza para dificultar el acceso al dispositivo, p. ej. interfonos, radiadores eléctricos de acumulación nocturna y termostatos.
- Con el perfil Tamper Resistant TORX® se pueden atornillar tanto tornillos Torx® H como tornillos Torx® normales.

Herramienta multiusos PocketStar

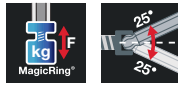

con cabeza esférica hexagonal MagicRing®, de 7 unid.

369RP7

n° pdo.	SB	Grid	€/unid.
23031		5	37,41
23033	x	5	37,79

Varilla Hexágono interior 2 / Varilla Hexágono interior 3 /  
Varilla Hexágono interior 3 / Varilla Hexágono interior 4 /  
Varilla Hexágono interior 5 / Varilla Hexágono interior 6 /  
Varilla Hexágono interior 3

Herramienta multiusos PocketStar



hexagonal, de 7 unid.

351PG7

n° pdo.	SB	Grid	€/unid.
23040		5	22,02
23041	x	5	22,39

Varilla Hexágono interior 2 / Varilla Hexágono interior 3 /  
Varilla Hexágono interior 3 / Varilla Hexágono interior 4 /  
Varilla Hexágono interior 5 / Varilla Hexágono interior 6 /  
Varilla Hexágono interior 3

CUADRO INFORMATIVO:  
MagicRing®



MagicRing® de Wiha

- El anillo elástico de acero sujeta los tornillos de cabeza hexagonal de forma segura
- Una innovación que convencerá a cualquier usuario.

CUADRO INFORMATIVO:  
con cabeza esférica hexagonal

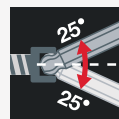

Cabeza esférica hexagonal de Wiha

- La punta de bola se puede girar un máximo de 25° a izquierda y derecha.





**hexagonal, de 7 unid.**

351PK7

n° pdo.			€/unid.
23035		5	19,15
23037	x	5	19,63

● Varilla Hexágono interior 1,5 / Varilla Hexágono interior 2 /  
 Varilla Hexágono interior 3 / Varilla Hexágono interior 3 /  
 Varilla Hexágono interior 4 / Varilla Hexágono interior 5 /  
 Varilla Hexágono interior 6



**Llave para armarios de distribución en forma de espiga**



en blíster

24681

n° pdo.							€/unid.
39076	5 - 8	9	3	7.0	PH2	1	31,62

**Juego de insertos de llave de vaso Gripper**



hexagonal con trinquete 3/8" y adaptador para destornillador en blíster 3 unid.

SB24602

n° pdo.		€/unid.
20783	1	88,74

**Llave para armarios de distribución en forma de cruz**



24667

n° pdo.							€/unid.
36114	5 - 8	9	3 - 5	7.0	PH2	5	20,92

**Inserto de llave de vaso Gripper**



de 3/8", en blíster

24601

n° pdo.				mm	SB		€/unid.
20554	7 - 19	3/8"	25.4	53.5	-	1	50,41

**Llave universal con doble articulación**



con cabeza triangular, cabeza cuadrada y paletón doble

24682

n° pdo.					€/unid.
44001	7-9	3 - 5	5 - 8	1	31,18

Juego de destornilladores con varillas intercambiables SYSTEM 6



en surtido, de 12 unid., incl. caja 281B11

n° pdo. €/unid.  
00623 1 123,69

○	Mango de destornillador SoftFinish®-telescopico para varillas intercambiables SYSTEM 6
⊖ ⊖	4.0 mm, 6 mm, 150 mm / 5.5 mm, 6.5 mm, 150 mm
⊕ ⊕	PH1, PH2, 150 mm
⊗ ⊗	PZ1, PZ2, 150 mm
⊛ ⊛	T10, T15, 150 mm / T20, T25, 150 mm / T30, T40, 150 mm
● ●	4.0 mm, 4 mm, 150 mm / 5.0 mm, 5 mm, 150 mm / 6.0 mm, 6 mm, 150 mm
	Caja

Con cabeza esférica

Juego de destornilladores con varillas intercambiables SYSTEM 6



en surtido, de 12 unid., incl. bolsa enrollable 281T11

n° pdo. €/unid.  
03591 1 112,26

○	Mango de destornillador SoftFinish®-telescopico para varillas intercambiables SYSTEM 6
⊖ ⊖	4.0 mm, 6 mm, 150 mm / 5.5 mm, 6.5 mm, 150 mm
⊕ ⊕	PH1, PH2, 150 mm
⊗ ⊗	PZ1, PZ2, 150 mm
⊛ ⊛	T10, T15, 150 mm / T20, T25, 150 mm / T30, T40, 150 mm
● ●	4.0 mm, 4 mm, 150 mm / 5.0 mm, 5 mm, 150 mm / 6.0 mm, 6 mm, 150 mm
	bolsa enrollable

Con cabeza esférica



CUADRO INFORMATIVO:  
**SYSTEM 6**

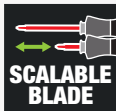

**Destornilladores con varillas intercambiables**

- Sistema de varillas intercambiables versátil y flexible con calidad industrial.
- Se adaptan para cualquier aplicación: Las varillas se pueden combinar, alargar y cambiar rápidamente.
- Presione el casquillo: La fijación de la varilla se suelta
- Ajuste la longitud de la varilla deseada (42 - 114 mm)
- Suelte el casquillo: La varilla se sujeta





Juego de destornilladores con varillas intercambiables SYSTEM 6



en surtido, de 7 unid., incl. bolsa enrollable

281T601

n° pdo.		€/unid.
32298	1	62,74

	Mango de destornillador SoftFinish®-telescopico para varillas intercambiables SYSTEM 6
	4.0 mm, 6 mm, 150 mm
	PH1, PH2, 150 mm
	PZ1, PZ2, 150 mm
	T10, T15, 150 mm / T20, T25, 150 mm
	bolsa enrollable



Juego de destornilladores con varillas intercambiables SYSTEM 6



con llave de vaso hexagonal, de 13 unid. incl. bolsa enrollable

U106T12

n° pdo.		€/unid.
27713	1	137,03

	Mango de destornillador SoftFinish®-telescopico para varillas intercambiables SYSTEM 6
	150 mm, 4.0 mm / 150 mm, 4.5 mm / 150 mm, 5.0 mm / 150 mm, 5.5 mm / 150 mm, 6.0 mm / 150 mm, 7.0 mm / 150 mm, 9.0 mm / 150 mm, 8.0 mm / 150 mm, 10.0 mm / 150 mm, 11.0 mm / 150 mm, 13.0 mm
	bolsa enrollable

Juego de destornilladores con varillas intercambiables SYSTEM 6



con llave de vaso hexagonal, de 9 unid. incl.  
bolsa enrollable

U106T8

n° pdo.	🏠	€/unid.
27712	1	94,91

- Mango de destornillador SoftFinish®-telescopico para varillas intercambiables SYSTEM 6
- 150 mm, 5.0 mm / 150 mm, 5.5 mm / 150 mm, 6.0 mm / 150 mm, 7.0 mm / 150 mm, 8.0 mm / 150 mm, 10.0 mm / 150 mm, 13.0 mm
- bolsa enrollable

Juego de destornilladores con varillas intercambiables SYSTEM 6 ESD



en surtido, de 7 unid., incl. bolsa enrollable

284ESDT601

n° pdo.	🏠	€/unid.
31497	1	64,99

- Mango de destornillador SoftFinish®-telescopico ESD para varillas intercambiables SYSTEM 6
- 3.5 mm, 4.5 mm, 150 mm / 4.0 mm, 6 mm, 150 mm / 5.5 mm, 6.5 mm, 150 mm
- ⊕ ⊕ PH1, PH2, 150 mm
- ● 5.0 mm, 5 mm, 150 mm
- bolsa enrollable

Con cabeza esférica



CUADRO INFORMATIVO:  
**Herramientas con derivación electrostática ESD**

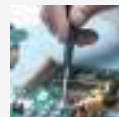

- Las herramientas disipadoras de Wiha derivan la energía eléctrica de forma controlada y segura.
- Las herramientas ESD cumplen la norma ESD IEC 61340-5-1.

Mango de destornillador SoftFinish®-telescopico



para varillas intercambiables SYSTEM 6

284

n° pdo.						€/unid.
30372	6.0	120	36	-	5	19,35

Mango de destornillador SoftFinish®-telescopico ESD



para varillas intercambiables SYSTEM 6

284ESD

n° pdo.					€/unid.
31496	6.0	120	36	5	23,64

Varilla intercambiable SYSTEM 6



Ranurado

28400

n° pdo.								€/unid.
27627	3.5	4.5	0.6	0.8	150	6	5	8,86
00629	4.0	6	0.8	1	150	6	5	8,86
00630	5.5	6.5	1.0	1.2	150	6	5	8,86

ranurado, Phillips

28401

n° pdo.							€/unid.
00665	4.0	PH1	0.8	150	6	5	8,86
00666	6.0	PH2	1.0	150	6	5	8,86

Phillips

28411

n° pdo.						€/unid.
00631	PH1	PH2	150	6	5	8,86
27628	PH2	PH3	150	6	5	8,86

Pozidriv

28422

n° pdo.						€/unid.
00632	PZ1	PZ2	150	6	5	8,86
27629	PZ2	PZ3	150	6	5	8,86

TORX®

28455

n° pdo.						€/unid.
00654	T6	T8	150	6	5	8,86
00655	T7	T9	150	6	5	8,86
00656	T10	T15	150	6	5	8,86
00657	T20	T25	150	6	5	8,86
00658	T30	T40	150	6	5	8,86

TORX® Tamper Resistant (con taladro)

284TR

n° pdo.						€/unid.
27630	T6H	T8H	150	6	5	10,23
27631	T7H	T9H	150	6	5	10,23
27632	T10H	T15H	150	6	5	10,23
27633	T20H	T25H	150	6	5	10,23
27634	T30H	T40H	150	6	5	10,23

con cabeza esférica hexagonal

28437





n° pdo.						€/unid.
00635	2.5	2.5	150	6	5	8,86
00636	3.0	3	150	6	5	8,86
00637	4.0	4	150	6	5	8,86
00638	5.0	5	150	6	5	8,86
00639	6.0	6	150	6	5	8,86

### Varilla intercambiable SYSTEM 6



#### con llave de vaso hexagonal

2844

n° pdo.		 mm			€/unid.
08900	4.0	150	6	1	10,56
08901	4.5	150	6	1	10,56
08902	5.0	150	6	1	10,56
08903	5.5	150	6	1	11,06
08904	6.0	150	6	1	11,06
08905	7.0	150	6	1	11,06
08906	8.0	150	6	1	11,06
08907	9.0	150	6	1	11,06
08908	10.0	150	6	1	11,06
08909	11.0	150	6	1	11,06
08911	13.0	150	6	1	11,06

### Portabits SYSTEM 6 con fijación mediante bola



7802

n° pdo.		 mm	 mm			€/unid.
03882	1/4"	150	6	10	5	17,73

### Varilla intercambiable SYSTEM 6



#### con adaptador cuadrado de 1/4" para insertos de llaves de vaso

7803

n° pdo.		 mm	 mm		€/unid.
03883	1/4"	150	6	5	15,72



**Juego de destornilladores con varillas intercambiables SYSTEM 4**



**en surtido de 12 unid incl. bolsa enrollable**

269T11

n° pdo.	📦	€/unid.
00610	1	123,95

- Mango de destornillador SoftFinish®-telescopico para varillas intercambiables SYSTEM 4
- ⊖ ⊖ 1.5 mm, 3 mm, 120 mm / 2.0 mm, 3.5 mm, 120 mm / 2.5 mm, 4 mm, 120 mm
- ⊕ ⊕ PH000, PH00, 120 mm / PH0, PH1, 120 mm
- ● 1.3 mm, 1.3 mm, 120 mm / 1.5 mm, 1.5 mm, 120 mm / 2.0 mm, 2 mm, 120 mm / 2.5 mm, 2.5 mm, 120 mm / 3.0 mm, 3 mm, 120 mm

bolsa enrollable

Con cabeza esférica

**en surtido de 12 unid incl. bolsa enrollable**

269T1101

n° pdo.	📦	€/unid.
27820	1	125,71

- Mango de destornillador SoftFinish®-telescopico para varillas intercambiables SYSTEM 4
- ⊖ ⊖ 1.5 mm, 3 mm, 120 mm / 2.0 mm, 3.5 mm, 120 mm / 2.5 mm, 4 mm, 120 mm
- ⊕ ⊕ PH000, PH00, 120 mm / PH0, PH1, 120 mm
- ⊗ ⊗ T6, T8, 120 mm / T7, T9, 120 mm
- ● 1.5 mm, 1.5 mm, 120 mm / 2.0 mm, 2 mm, 120 mm / 2.5 mm, 2.5 mm, 120 mm

bolsa enrollable

**Juego de destornilladores con varillas intercambiables SYSTEM 4**



**ranurados, Phillips, de hexágono exterior, de 5 unid., incl. bolsa enrollable**

269T4

n° pdo.	📦	€/unid.
00613	1	50,27

- Mango de destornillador SoftFinish®-telescopico para varillas intercambiables SYSTEM 4
  - ⊖ ⊕ 2.0 mm, PH00, 120 mm / 3.0 mm, PH0, 120 mm / 4.0 mm, PH1, 120 mm
- bolsa enrollable

**ranurados, Phillips, hexagonales, de 7 unid., incl. bolsa enrollable**

269T6

n° pdo.	📦	€/unid.
00616	1	72,14

- Mango de destornillador SoftFinish®-telescopico para varillas intercambiables SYSTEM 4
  - ⊖ ⊖ 1.5 mm, 3 mm, 120 mm / 2.0 mm, 3.5 mm, 120 mm / 2.5 mm, 4 mm, 120 mm
  - ⊕ ⊕ PH000, PH00, 120 mm / PH0, PH1, 120 mm
- bolsa enrollable



Juego de bits SYSTEM 4 ESD



en surtido, de 27 unid., incl. caja

7000EB26ESD

n° pdo.		€/unid.
33848	1	126,70

- 1 x Mango de destornillador SoftFinish®-telescopico ESD para varillas intercambiables SYSTEM 4
- 1 x Portabits SYSTEM 4 con fijación mediante bola Conexión para bits C 4 (4 mm).
- ⊖ 1 x 1.5 mm / 1 x 2.0 mm / 1 x 3.0 mm / 1 x 4.0 mm
- ⊕ 1 x PH000 / 1 x PH00 / 1 x PH0 / 1 x PH1
- 1 x 0.7 mm / 1 x 0.9 mm / 1 x 1.3 mm 0,05 / 1 x 1.5 mm / 1 x 2.0 mm / 1 x 2.5 mm / 1 x 3.0 mm / 1 x 4.0 mm 5/32"
- ⊛ 1 x T3 / 1 x T4 / 1 x T5 / 1 x T6 / 1 x T7 / 1 x T8 / 1 x T9 / 1 x T10
- 1 x Caja

IEC 61340-5-1.  
DIN 3126, ISO 1173, forma C 4.

Juego de bits SYSTEM 4 ESD



en surtido, de 17 unid., incl. caja

7000EB16ESD

n° pdo.		€/unid.
33503	1	75,80

- 1 x Mango de destornillador SoftFinish®-telescopico ESD para varillas intercambiables SYSTEM 4
- 1 x Portabits SYSTEM 4 con fijación mediante bola Conexión para bits C 4 (4 mm).
- ⊖ 1 x 2.0 mm / 1 x 3.0 mm
- ⊕ 1 x PH000 / 1 x PH00 / 1 x PH0 / 1 x PH1
- ⊛ 1 x T3 / 1 x T4 / 1 x T5 / 1 x T6 / 1 x T8
- 1 x 0.9 mm / 1 x 1.3 mm 0,05 / 1 x 1.5 mm
- 1 x Caja

IEC 61340-5-1.  
DIN 3126, ISO 1173, forma C 4.



CUADRO INFORMATIVO:  
SYSTEM 4



Destornilladores con varillas intercambiables

- Sistema de varillas intercambiables de precisión versátil y flexible para tareas de atornillado de precisión.
- Se adaptan para cualquier aplicación: Las varillas se pueden combinar, alargar y cambiar rápidamente.
- Presione el casquillo: La fijación de la varilla se suelta
- Mantenga pulsado el casquillo: Ajuste la longitud de la varilla deseada (18 - 90 mm)
- Suelte el casquillo: La varilla se sujeta



**Juego de destornilladores con varillas intercambiables SYSTEM 4 ESD**



**en surtido de 12 unid incl. bolsa enrollable**

2691T11ESD

n° pdo.	📦	€/unid.
31499	1	127,46

○	Mango de destornillador SoftFinish®-telescopico ESD para varillas intercambiables SYSTEM 4
⊖ ⊖	1.5 mm, 3 mm, 120 mm / 2.0 mm, 3.5 mm, 120 mm / 2.5 mm, 4 mm, 120 mm
⊕ ⊕	PH000, PH00, 120 mm / PH0, PH1, 120 mm
⊕ ⊕	T6, T8, 120 mm / T7, T9, 120 mm
● ●	1.5 mm, 1.5 mm, 120 mm / 2.0 mm, 2 mm, 120 mm / 2.5 mm, 2.5 mm, 120 mm
	bolsa enrollable

**Mango de destornillador SoftFinish®-telescopico**



**para varillas intercambiables SYSTEM 4**

269

n° pdo.	🔩	📏	⚙️	📦	€/unid.
30373	4.0	105	23	10	17,61

**Mango de destornillador SoftFinish®-telescopico ESD**



**para varillas intercambiables SYSTEM 4**

269ESD

n° pdo.	🔩	📏	⚙️	📦	€/unid.
31498	4.0	105	23	10	19,35

## Varilla intercambiable SYSTEM 4



### Ranurado

26900

n° pdo.					mm			€/unid.
00576	1.5	3	0.3	0.5	120	4	5	10,66
00577	2.0	3.5	0.4	0.6	120	4	5	10,66
00578	2.5	4	0.4	0.8	120	4	5	10,66

### Ranurado/ Phillips

26901

n° pdo.					mm			€/unid.
00601	2.0	PH00	0.4		120	4	5	10,66
00602	3.0	PH0	0.5		120	4	5	10,66
00603	4.0	PH1	0.8		120	4	5	10,66

### Phillips

26911

n° pdo.			mm			€/unid.
00579	PH000	PH00	120	4	5	10,66
00580	PH0	PH1	120	4	5	10,66

### Pozidriv

26922

n° pdo.			mm			€/unid.
03186	PZ0	PZ1	120	4	5	10,66

### TORX®

26955

n° pdo.			mm			€/unid.
26122	T1	T2	120	4	5	10,66
26123	T3	T4	120	4	5	10,66
26124	T5	T6	120	4	5	10,66
00597	T6	T8	120	4	5	10,66
00598	T7	T9	120	4	5	10,66
00599	T10	T15	120	4	5	10,66
00600	T15	T20	120	4	5	10,66

### con cabeza esférica hexagonal

26937

n° pdo.			mm			€/unid.
00582	1.3•	1.3	120	4	5	10,66
00583	1.5•	1.5	120	4	5	10,66
00584	2.0•	2	120	4	5	10,66
00585	2.5•	2.5	120	4	5	10,66
00586	3.0•	3	120	4	5	10,66
00587	4.0•	4	120	4	5	10,66

•Con cabeza esférica

## Portabits SYSTEM 4 con fijación mediante bola



### Conexión para bits C 4 (4 mm).

269SE

n° pdo.					€/unid.
09195	4.0	4	9	1	14,97





## Llave Allen

### **Acceso difícil - solución sencilla.**

Las llaves Allen de Wiha, son esenciales para cualquier usuario aunque se enfrente a una tarea de atornillado en condiciones de trabajo exigentes. Las llaves Allen de Wiha con lado reducido de la llave corta, resultan ideales para tornillos de difícil acceso. El aumento del espacio de trabajo de la mano en más del 30% reduce considerablemente el riesgo de sufrir lesiones.

Las herramientas de cabeza esférica de Wiha, permiten realizar atornillados en una posición angular de hasta 25° por lado. Debido a que la herramienta no se desliza del tornillo, se reduce el peligro de accidente. MagicRing® y MagicSpring® de Wiha permiten sujetar los tornillos de acero, y de materiales no magnéticos, de forma segura en cualquier posición.

Soporte de llaves Allen

Juego de llaves Allen en soporte ErgoStar Cabeza esférica hexagonal MagicRing®, de 10 unid., en colores luminosos  
Página 206

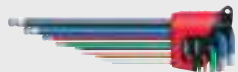

Juego de llaves Allen en soporte ErgoStar con cabeza esférica hexagonal MagicRing®, de 10 unid., en cromado mate  
Página 207



Juego de llaves Allen en soporte ProStar con cabeza esférica hexagonal con brazo corto, de 10 unid., en cromado mate  
Página 208



Juego de llaves Allen en soporte ProStar con cabeza esférica hexagonal, de 10 unid., en cromado mate  
Página 208



Juego de llaves Allen en soporte Compact con cabeza esférica hexagonal, de 10 unid., en cromado mate  
Página 209



Juego de llaves Allen en soporte ErgoStar TORX® MagicSpring® de 14 unid., acabado en oxidación negra  
Página 211

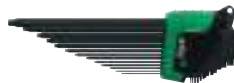

Juego de llaves Allen en soporte ProStar TORX®, de 14 unid., en plata titanio  
Página 213



Juego de llaves Allen en soporte ProStar TORX®, de 14 unid., acabado en oxidación negra  
Página 214



Juego de llaves Allen en soporte Classic TORX®, de 9 unid., cortas, acabado en oxidación negra  
Página 214



Llave Allen con mango corredizo Comfort grip hexagonal MagicRing® con acoplamiento lateral, en cromado mate  
Página 216



Llave Allen con mango de llave TORX®, acabado en oxidación negra  
Página 217



Llave Allen con mango de bandera TORX®, acabado en oxidación negra  
Página 217



Juego de llaves Allen en soporte ErgoStar

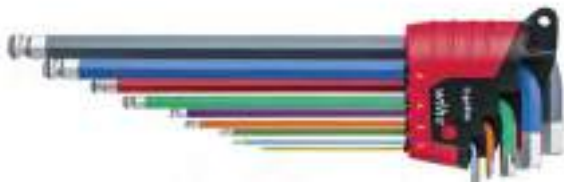

Cabeza esférica hexagonal MagicRing®, de 10 unid., en colores luminosos

369RE9F

n° pdo.	SB	Grid	€/unid.
41979		5	71,52
43850	x	5	73,13
1.5 mm / 2.0 mm / 2.5 mm / 3.0 mm / 4.0 mm / 5.0 mm / 6.0 mm / 8.0 mm / 10.0 mm			
Soporte ErgoStar			

Juego de llaves Allen en soporte ErgoStar

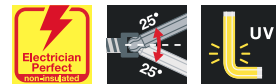
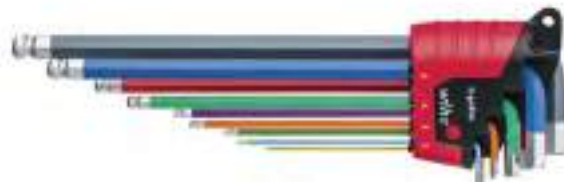

con cabeza esférica hexagonal, de 10 unid., en colores luminosos

369E9F

n° pdo.	SB	Grid	€/unid.
41483		5	56,31
43849	x	5	57,92
● 1.5 mm / 2.0 mm / 2.5 mm / 3.0 mm / 4.0 mm / 5.0 mm / 6.0 mm / 8.0 mm / 10.0 mm			
Soporte ErgoStar			

CUADRO INFORMATIVO:  
Herramientas en colores luminosos



- Los bits de colores y el ErgoStar con llaves Allen de colores se iluminan al enfocarlos con luz UV.
- Esto permite encontrar de nuevo las herramientas que se hayan perdido de un modo rápido y sencillo.
- El complemento perfecto para las herramientas en colores luminosos es la linterna de Wiha con luz UV.

CUADRO INFORMATIVO:  
ErgoStar



Acceder con un giro a la llave Allen correcta

- Girando cualquier llave Allen, todas las llaves Allen estarán listas para extraer.
- Punto de tope fijo para la fijación de las llaves Allen en el soporte.
- La fijación innovadora asegura el asiento de las llaves Allen en estado cerrado y abierto.
- El formato compacto ahorra espacio en el banco de trabajo y en la caja de herramientas.
- Soporte de pared para el almacenamiento práctico del soporte ErgoStar® en el taller.

Juego de llaves Allen en soporte ErgoStar



con cabeza esférica hexagonal MagicRing®, de 10 unid., en cromado mate

369RH9

n° pdo.			€/unid.
37351		5	47,49
43851	x	5	73,13

1.5 mm / 2.0 mm / 2.5 mm / 3.0 mm / 4.0 mm / 5.0 mm / 6.0 mm / 8.0 mm / 10.0 mm

Soporte ErgoStar

De acuerdo con ISO 2936L.

Juego de llaves Allen en soporte ErgoStar

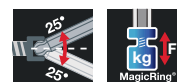

con cabeza esférica hexagonal MagicRing®, de 14 unid., en cromado mate, en versión en pulgadas

369RHZ13

n° pdo.			€/unid.
36521		5	66,19
43852	x	5	67,80

1.3 mm 0,05" / 1.6 mm 1/16" / 2.0 mm 5/64" / 2.4 mm 3/32" / 2.8 mm 7/64"

3.2 mm 1/8" / 3.6 mm 9/64" / 4.0 mm 5/32" / 4.8 mm 3/16" / 5.6 mm 7/32" / 6.4 mm 1/4" / 7.9 mm 5/16" / 9.5 mm 3/8"

Soporte ErgoStar

De acuerdo con ASME B18.3.

CUADRO INFORMATIVO: MagicRing®



MagicRing® de Wiha

- El anillo elástico de acero sujeta los tornillos de cabeza hexagonal de forma segura
- Una innovación que convencerá a cualquier usuario.

CUADRO INFORMATIVO: con cabeza esférica hexagonal

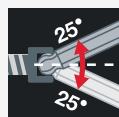
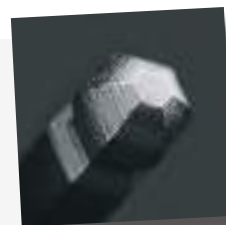

Cabeza esférica hexagonal de Wiha

- La punta de bola se puede girar un máximo de 25° a izquierda y derecha.

### Juego de llaves Allen en soporte ProStar



con cabeza esférica hexagonal con brazo corto, de 10 unid., en cromado mate

369TS9

n° pdo.		€/unid.
35480		5 40,97
35481	x	5 42,58
1.5 mm / 2.0 mm / 2.5 mm / 3.0 mm / 4.0 mm / 5.0 mm / 6.0 mm / 8.0 mm / 10.0 mm soporte ProStar		

De acuerdo con ISO 2936L.

### Juego de llaves Allen en soporte ProStar



con cabeza esférica hexagonal, de 14 unid., acabado en oxidación negra, en versión en pulgadas

369SZ13B

n° pdo.		€/unid.
24189	5	39,46
24851	5	41,08
1.3 mm 0,05" / 1.6 mm 1/16" / 2.0 mm 5/64" / 2.4 mm 3/32" / 2.8 mm 7/64" / 3.2 mm 1/8" / 3.6 mm 9/64" / 4.0 mm 5/32" / 4.8 mm 3/16" / 5.6 mm 7/32" / 6.4 mm 1/4" / 7.9 mm 5/16" / 9.5 mm 3/8" / 1.3 mm soporte ProStar		

De acuerdo con ASME B18.3.

### Juego de llaves Allen en soporte ProStar



### CUADRO INFORMATIVO: Llave Allen con brazo corto



**Especial para tornillos de difícil acceso y lugares estrechos**

- Accesibilidad mejorada gracias a la longitud reducida un 60 % del lado corto de la llave Allen.
- El aumento del espacio de trabajo de la mano en más del 30% reduce del riesgo de sufrir lesiones en los nudillos y en las yemas de los dedos gracias a la flexión de 95° de la llave Allen.
- La geometría de cabeza esférica permite el atornillado en un ángulo de hasta 25°.

con cabeza esférica hexagonal, de 10 unid., en cromado mate

369S9

n° pdo.		€/unid.
07185	5	33,34
07192	x	5 34,95
1.5 mm / 2.0 mm / 2.5 mm / 3.0 mm / 4.0 mm / 5.0 mm / 6.0 mm / 8.0 mm / 10.0 mm soporte ProStar		

De acuerdo con ISO 2936L.



**Juego de llaves Allen en soporte Compact**



**con cabeza esférica hexagonal, de 12 unid., en cromado mate**

369H11

n° pdo.		€/unid.
36453	5	44,73

	1.5 mm / 2.0 mm / 2.5 mm / 3.0 mm / 4.0 mm / 5.0 mm / 6.0 mm / 7.0 mm / 8.0 mm / 9.0 mm / 10.0 mm
	Soporte Compact

De acuerdo con ISO 2936L.

**Juego de llaves Allen en soporte Compact**



**con cabeza esférica hexagonal, de 10 unid., en cromado mate**

369KH9

n° pdo.		€/unid.
40410	10	28,28
40411	5	29,90

	1.5 mm / 2.0 mm / 2.5 mm / 3.0 mm / 4.0 mm / 5.0 mm / 6.0 mm / 8.0 mm / 10.0 mm
	Soporte Compact

De acuerdo con ISO 2936L.

**Juego de llaves Allen en soporte Compact**



**con cabeza esférica hexagonal, de 10 unid., en cromado mate**

369H9

n° pdo.		€/unid.
01418	5	32,45
02292	5	34,07

	1.5 mm / 2.0 mm / 2.5 mm / 3.0 mm / 4.0 mm / 5.0 mm / 6.0 mm / 8.0 mm / 10.0 mm
	Soporte Compact

De acuerdo con ISO 2936L.

**Juego de llaves Allen en soporte Classic**

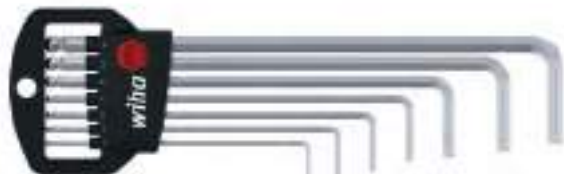

**con cabeza esférica hexagonal, de 8 unid., en cromado mate**

369H7

n° pdo.		€/unid.
01416	5	24,17
03723	10	25,78

	1.5 mm / 2.0 mm / 2.5 mm / 3.0 mm / 4.0 mm / 5.0 mm / 6.0 mm
	Soporte Classic

De acuerdo con ISO 2936L.

Juego de llaves Allen en soporte Classic

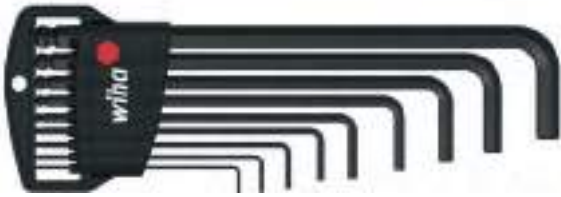

con cabeza esférica hexagonal, de 10 unid., acabado en oxidación negra

369H9B

n° pdo.			€/unid.
03879		5	27,40
03992	x	10	29,01
	1.5 mm / 2.0 mm / 2.5 mm / 3.0 mm / 4.0 mm / 5.0 mm / 6.0 mm / 8.0 mm / 10.0 mm		
Soporte Classic			

De acuerdo con ISO 2936L.

Juego de llaves Allen en soporte Classic

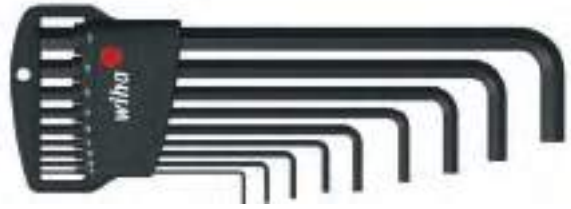

hexagonales, de 10 unid., acabado en oxidación negra

352H9B

n° pdo.			€/unid.
06386		5	16,32
	1.5 mm / 2.0 mm / 2.5 mm / 3.0 mm / 4.0 mm / 5.0 mm / 6.0 mm / 8.0 mm / 10.0 mm		
Soporte Classic			

De acuerdo con ISO 2936L.

Juego de llaves Allen en soporte Classic

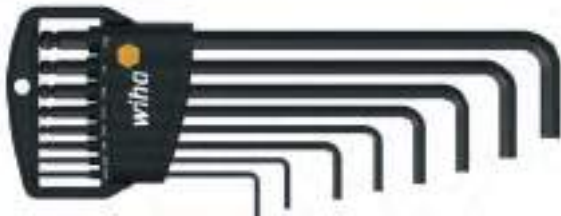

con cabeza esférica hexagonal, de 9 unid., acabado en oxidación negra, en versión en pulgadas

369HZ8

n° pdo.			€/unid.
01420		5	31,77
02939	x	10	33,38
	2.0 mm 5/64" / 2.4 mm 3/32" / 3.2 mm 1/8" / 4.0 mm 5/32" / 4.8 mm 3/16" / 5.6 mm 7/32" / 6.4 mm 1/4" / 7.9 mm 5/16"		
Soporte Classic			

De acuerdo con ASME B18.3.

Juego de llaves Allen en soporte Classic



hexagonales, de 10 unid., acabado en oxidación negra

350H9

n° pdo.			€/unid.
06379		10	10,03
	1.5 mm / 2.0 mm / 2.5 mm / 3.0 mm / 4.0 mm / 5.0 mm / 6.0 mm / 8.0 mm / 10.0 mm		
Soporte Classic			

ISO 2936K.

Juego de llaves Allen en soporte Classic



hexagonales, de 8 unid., acabado en oxidación negra

350H7

n° pdo.	SB	€/unid.
06378	10	6,82
●	1.5 mm / 2.0 mm / 2.5 mm / 3.0 mm / 4.0 mm / 5.0 mm / 6.0 mm	
	Soporte Classic	

ISO 2936K.

Juego de llaves Allen en soporte ErgoStar



TORX® MagicSpring® de 14 unid., acabado en oxidación negra

366RHZ13

n° pdo.	SB	€/unid.
36503	5	79,95
43848	x	5
●	T5 / T6 / T7 / T8 / T9 / T10 / T15 / T20 / T25 / T27 / T30 / T40 / T45	
	Soporte ErgoStar	

Juego de llaves Allen en soporte Classic

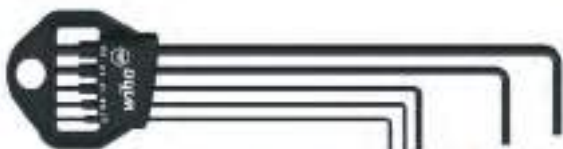

hexagonales, de 6 unid., acabado en oxidación negra

352HM5B

n° pdo.	SB	€/unid.
06382	10	8,13
●	0.7 mm / 0.9 mm / 1.3 mm / 1.5 mm / 2.0 mm	
	Soporte Classic	

De acuerdo con ISO 2936L.

CUADRO INFORMATIVO: MagicSpring®



MagicSpring® TORX® de Wiha

- El resorte de acero inoxidable sujeta los tornillos TORX® o TORX PLUS® de un modo seguro.
- Una innovación que convencerá a cualquier usuario.

Juego de llaves Allen en soporte Classic

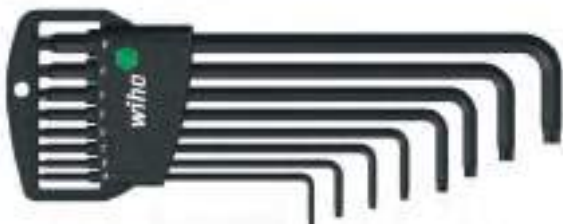

TORX® MagicSpring® con cabeza esférica, de 9 unid., acabado en oxidación negra

366RH8

n° pdo.		€/unid.
34740	5	50,91
	T9 / T10 / T15 / T20 / T25 / T27 / T30 / T40	
Soporte Classic		

Juego de llaves Allen en soporte ErgoStar



TORX® con cabeza esférica, de 14 unid., acabado en oxidación negra

366BEHZ13

n° pdo.		€/unid.
36487	5	76,68
43847	x	5
	T5 / T6 / T7 / T8 / T9 / T10 / T15 / T20 / T25 / T27 / T30 / T40 / T45	
Soporte ErgoStar		

TORX®, con cabeza esférica, a partir del tamaño T9

Juego de llaves Allen en soporte Classic



TORX® MagicSpring® de 8 unid., acabado en oxidación negra

366RHM7

n° pdo.		€/unid.
33753	5	38,52
33754	x	5
	T6 / T7 / T8 / T9 / T10 / T15 / T20	
Soporte Classic		

CUADRO INFORMATIVO:  
TORX® con cabeza esférica

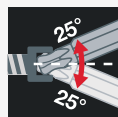

Cabeza esférica TORX® de Wiha

- Con geometría optimizada de la cabeza esférica TORX®
- Resistencia aumentada gracias al moldeado especial en frío realizado en instalaciones desarrolladas por Wiha especialmente para este fin.
- Permite atornillar en ángulos de hasta 25°.
- Mayor facilidad para insertar las herramientas y para atornillar, especialmente en lugares de difícil acceso.
- Programa amplio de productos: llaves, bits y destornilladores SoftFinish®.

Juego de llaves Allen en soporte Classic

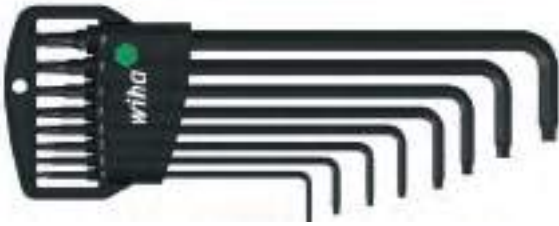

**TORX® con cabeza esférica, de 9 unid., acabado en oxidación negra**

366BEH8

n° pdo.			€/unid.
32394		5	42,82
32395	x	10	44,43
	T9 / T10 / T15 / T20 / T25 / T27 / T30 / T40		
Soporte Classic			

Juego de llaves Allen en soporte ProStar



**TORX®, de 14 unid., en plata titanio**

366SZ13TS

n° pdo.			€/unid.
39104		5	64,34
39105	x	5	65,95
	T5 / T6 / T7 / T8 / T9 / T10 / T15 / T20 / T25 / T27 / T30 / T40 / T45		
soporte ProStar			

Juego de llaves Allen en soporte ProStar



**Stubby, con cabeza esférica TORX®, en titanio plateado, de 14 unid.**

366BETSZ13TS

n° pdo.		€/unid.
40979	5	90,65
	T5 / T6 / T7 / T8 / T9 / T10 / T15 / T20 / T25 / T27 / T30 / T40 / T45	
soporte ProStar		

TORX®, con cabeza esférica, a partir del tamaño T9

CUADRO INFORMATIVO:  
**Llave Allen con brazo corto**

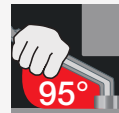

**Especial para tornillos de difícil acceso y lugares estrechos**

- Accesibilidad mejorada gracias a la longitud reducida un 60 % del lado corto de la llave Allen.
- El aumento del espacio de trabajo de la mano en más del 30% reduce del riesgo de sufrir lesiones en los nudillos y en las yemas de los dedos gracias a la flexión de 95° de la llave Allen.
- La geometría de cabeza esférica permite el atornillado en un ángulo de hasta 25°.

Juego de llaves Allen en soporte ProStar



TORX®, de 14 unid., acabado en oxidación negra		366SZ13
n° pdo.		€/unid.
24312	5	61,82
24852	x	5 63,44
	T5 / T6 / T7 / T8 / T9 / T10 / T15 / T20 / T25 / T27 / T30 / T40 / T50	
	soporte ProStar	

Juego de llaves Allen en soporte Classic



TORX®, de 9 unid., cortas, acabado en oxidación negra		363H8
n° pdo.		€/unid.
36461	5	31,15
	T9 / T10 / T15 / T20 / T25 / T27 / T30 / T40	
	Soporte Classic	

Juego de llaves Allen en soporte Classic

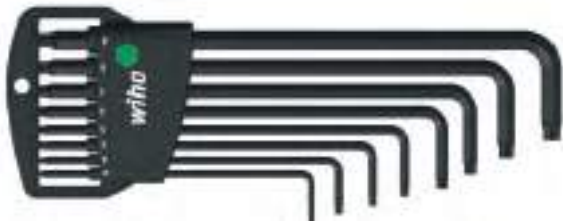

TORX®, de 9 unid., acabado en oxidación negra		366H8
n° pdo.		€/unid.
34736	5	37,04
	T9 / T10 / T15 / T20 / T25 / T27 / T30 / T40	
	Soporte Classic	

Juego de llaves Allen



TORX®, de 10 unid., cortas, acabado en oxidación negra, incl. soporte de banco de trabajo		363VB
n° pdo.		€/unid.
01326	1	69,07
	T10 / T15 / T20 / T25 / T30 / T40 / T50 / T55 / T60	
	Soporte para banco de trabajo	

Juego de llaves Allen en soporte Classic



**TORX PLUS®**, de 9 unid., acabado en oxidación negra

361IPH8

n° pdo.		€/unid.
36459	5	39,91
9IP / 10IP / 15IP / 20IP / 25IP / 27IP / 30IP / 40IP Soporte Classic		

Juego de llaves Allen en soporte Classic



**TORX® Tamper Resistant (con taladro)**, de 9 unid., acabado en oxidación negra

363TRH8

n° pdo.		€/unid.
36462	5	40,53
T9H / T10H / T15H / T20H / T25H / T27H / T30H / T40H Soporte Classic		

Juego de llaves Allen con mango en T Comfort grip



hexagonales, de 6 unid., con acoplamiento lateral, en cromado mate

334DSK6

n° pdo.			€/unid.
26247		1	39,43
	2.5 mm / 3.0 mm / 4.0 mm / 5.0 mm / 6.0 mm / 8.0 mm		

Juego de llaves Allen con mango en T Comfort grip



TORX®, de 6 unid., con acoplamiento lateral, en cromado mate

364DSK6

n° pdo.			€/unid.
26248		1	74,94
	T10 / T15 / T20 / T25 / T30 / T40		

Juego de llaves Allen con mango corredizo



hexagonales MagicRing® en soporte de banco de trabajo, de 6 unid., en niquelado brillante

334RVB

n° pdo.			€/unid.
22096		1	69,52
	3.0 mm / 4.0 mm / 5.0 mm / 6.0 mm / 8.0 mm / 10.0 mm		

Juego de llaves Allen con mango corredizo



hexagonales, de 8 unid., incl. niquelado brillante, en soporte de banco de trabajo

334VB

n° pdo.			€/unid.
00953		1	55,87
	2.0 mm / 2.5 mm / 3.0 mm / 4.0 mm / 5.0 mm / 6.0 mm / 8.0 mm		
	Soporte para banco de trabajo		



Juego de llaves Allen con mango corredizo



**TORX®, de 8 unid., en cromado mate, incl. soporte de banco de trabajo**

364VB

n° pdo.		€/unid.
01348	1	107,46
	T10 / T15 / T20 / T25 / T30 / T40 / T50	
Soporte para banco de trabajo		

Juego de llaves Allen con mango de llave



**TORX PLUS®, de 8 unid., acabado en oxidación negra, incl. soporte de banco de trabajo**

365IPVB

n° pdo.		€/unid.
26261	1	69,58
	6IP / 7IP / 8IP / 9IP / 10IP / 15IP / 20IP	
Soporte para banco de trabajo		

Juego de llaves Allen con mango de llave



**TORX de 8 unid., acabado en oxidación negra, incl. soporte de banco de trabajo**

365VB

n° pdo.		€/unid.
25624	1	46,41
	T6 / T7 / T8 / T9 / T10 / T15 / T20	
Soporte para banco de trabajo		

Juego de llaves Allen con mango de bandera



**TORX, de 8 unid., acabado en oxidación negra, incl. soporte de banco de trabajo**

370VB

n° pdo.		€/unid.
25625	1	46,41
	T6 / T7 / T8 / T9 / T10 / T15 / T20	
Soporte para banco de trabajo		

### Llave Allen



#### Cabeza esférica hexagonal MagicRing®, de 9 unid., en colores luminosos

369RF

n° pdo.	mm	mm	mm	Color	Unid.	€/unid.
41973	3.0	128	23	naranja	10	5,94
41974	4.0	142	29	púrpura	10	7,16
41975	5.0	163	33	verde oscuro	10	7,70
41976	6.0	184	38	roja	10	9,35
41977	8.0	206	44	azul oscuro	10	15,03
41978	10.0	231	50	antracita	5	19,23

De acuerdo con ISO 2936L.

### Llave Allen



#### Cabeza esférica hexagonal en colores luminosos

369F

n° pdo.	mm	mm	mm	Color	Unid.	€/unid.
41894	1.5	91	15	amarilla	10	3,19
41895	2.0	101	18	azul claro	10	3,26
41896	2.5	113	20	verde claro	10	3,45
41897	3.0	128	23	naranja	10	3,71
41898	4.0	142	29	púrpura	10	4,81
41899	5.0	163	33	verde oscuro	10	5,25
41900	6.0	184	38	roja	10	6,58
41901	8.0	206	44	azul oscuro	10	11,59
41902	10.0	231	50	antracita	5	14,74

### Llave Allen

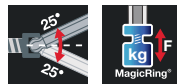

#### con cabeza esférica hexagonal MagicRing®, en cromado mate

369RF

n° pdo.	mm	mm	mm	Unid.	€/unid.
20549	3.0	128	23	10	4,99
20550	4.0	142	29	10	5,11
20570	5.0	163	33	10	5,71
20551	6.0	184	38	10	6,70
20552	8.0	206	44	10	9,52
20553	10.0	231	50	5	12,26

De acuerdo con ISO 2936L.

### Llave Allen



#### con cabeza esférica hexagonal MagicRing®, en versión en pulgadas, en cromado mate

369RZ

n° pdo.	mm	mm	mm	mm	Unid.	€/unid.
24302	1/8"	121	23	3.2	10	5,18
24304	9/64"	136	27	3.6	10	5,33
24303	5/32"	148	29	4.0	10	5,44
24305	3/16"	163	33	4.8	10	6,00
24306	7/32"	176	36	5.6	10	6,27
24307	1/4"	191	38	6.4	10	7,14
24308	5/16"	210	43	7.9	10	9,89
24341	3/8"	232	49	9.5	10	12,39

De acuerdo con ASME B18.3.

### Llave Allen



#### con cabeza esférica hexagonal con brazo corto, en cromado mate

369T

n° pdo.		mm			€/unid.
35482	1.5	91	5.5	10	2,32
35483	2.0	101	9	10	2,32
35484	2.5	113	9.5	10	2,41
35485	3.0	128	11	10	3,39
35486	4.0	142	13	10	3,39
35487	5.0	163	15	10	3,92
35488	6.0	184	18	10	4,84
35489	8.0	206	22	10	8,47
35490	10.0	231	28	5	10,74

De acuerdo con ISO 2936L.

### Llave Allen



#### con cabeza esférica hexagonal, corta, en cromado mate

369K

n° pdo.		mm			€/unid.
40401	1.5	46	15	10	1,62
40402	2.0	51	18	10	1,62
40403	2.5	57	20	10	1,63
40404	3.0	64	23	10	1,64
40405	4.0	72	29	10	1,85
40406	5.0	83	33	10	2,43
40407	6.0	94	38	10	3,07
40408	8.0	105	44	10	4,85
40409	10.0	119	50	10	6,54

ISO 2936K.

### Llave Allen



#### con cabeza esférica hexagonal, en cromado mate

369

n° pdo.		mm			€/unid.
01392	1.5	91	15	10	1,86
01393	2.0	101	18	10	1,86
01395	2.5	113	20	10	1,88
01396	3.0	128	23	10	2,00
01398	4.0	142	29	10	2,62
01400	5.0	163	33	10	3,06
01402	6.0	184	38	10	3,87
07922	7.0	195	39	5	5,96
01404	8.0	206	44	10	6,70
36452	9.0	217	47	5	7,88
01406	10.0	231	50	5	8,51
01408	12.0	259	57	5	12,36

De acuerdo con ISO 2936L.

### Llave Allen



#### con cabeza esférica hexagonal, en versión en pulgadas, en cromado mate

369Z

n° pdo.		mm				€/unid.
29471	0,05"	72	13	1.3	10	2,39
29472	1/16"	80	15	1.6	10	2,41
29474	5/64"	88	18	2.0	10	2,52
29473	3/32"	101	20	2.4	10	2,45
29475	7/64"	111	21	2.8	10	2,62

De acuerdo con ASME B18.3.

## Llave Allen



### SINGLE-ITEM

369B

n° pdo.		mm			€/unid.
01391	1.3	74	14	10	1,54
05638	1.5	91	15	10	1,54
03868	2.0	101	18	10	1,54
03869	2.5	113	20	10	1,63
03870	3.0	128	23	10	1,63
03871	4.0	142	29	10	2,24
03872	5.0	163	33	10	2,49
03873	6.0	184	38	10	3,20
03874	8.0	206	44	10	5,39
03875	10.0	231	50	10	7,45
03876	12.0	259	57	10	9,74

De acuerdo con ISO 2936L.

## Llave Allen



### hexagonal, acabado en oxidación negra

352B

n° pdo.		mm			€/unid.
06358	0.7	67	6	10	2,43
06359	0.9	70	9	10	2,06
06360	1.3	80	13	10	1,10
06059	1.5	91	15	10	0,80
06361	2.0	101	18	10	0,76
06362	2.5	113	20	10	0,94
06363	3.0	128	23	10	1,10
06364	4.0	142	29	10	1,38
06365	5.0	163	33	10	1,53
06366	6.0	184	38	10	2,04
06367	7.0	194	41	10	2,56
06368	8.0	206	44	10	3,03
06369	10.0	231	50	5	4,65
06370	12.0	259	57	5	7,45
06371	14.0	291	70	5	10,46

De acuerdo con ISO 2936L.

## Llave Allen



### con cabeza esférica hexagonal, en versión en pulgadas, acabado en oxidación negra

369ZB

n° pdo.		mm				€/unid.
01422	0,05"	72	13	1.3	10	1,64
01423	1/16"	80	15	1.6	10	1,58
01431	5/64"	88	18	2.0	10	1,58
01427	3/32"	101	20	2.4	10	1,72
01433	7/64"	111	21	2.8	10	1,80
01425	1/8"	121	23	3.2	10	1,85
01434	9/64"	136	27	3.6	10	2,10
01430	5/32"	148	29	4.0	10	2,45
01426	3/16"	163	33	4.8	10	2,95
01432	7/32"	176	36	5.6	10	3,14
01424	1/4"	191	38	6.4	10	3,71
01429	5/16"	210	43	7.9	10	5,45
01428	3/8"	232	49	9.5	5	7,56

De acuerdo con ASME B18.3.

## Llave Allen



### hexagonal corta, acabado en oxidación negra

350

n° pdo.		mm			€/unid.
06218	1.3	41	13	10	0,34
01121	1.5	46	15	10	0,34
01122	2.0	51	18	10	0,34
01123	2.5	57	20	10	0,35
01124	3.0	64	23	10	0,45
01126	4.0	72	29	10	0,58
01128	5.0	83	33	10	0,77
01130	6.0	94	38	10	1,03
01131	7.0	99	41	10	1,46
01132	8.0	105	44	50	1,75
01133	9.0	112	47	5	2,40
01134	10.0	119	50	5	2,56
01135	11.0	126	53	5	3,14
01136	12.0	134	57	5	4,76
01137	14.0	151	70	5	6,12
01138	17.0	173	80	5	10,31
01139	19.0	195	89	5	13,50
01140	22.0	217	102	1	20,62
01141	24.0	241	114	1	31,58
01142	27.0	271	127	1	39,22
01143	32.0	339	157	1	81,09

ISO 2936K.

## Llave Allen



### TORX® MagicSpring®, acabado en oxidación negra

366R

n° pdo.		mm			€/unid.
31233	T6	80	15	1/16"	5,14
31235	T8	101	20	3/32"	5,14
31234	T7	88	18	5/64"	5,14
31236	T9	111	21	7/64"	5,14
31237	T10	121	23	1/8"	5,57
31238	T15	136	27	9/64"	5,82
31239	T20	148	29	5/32"	6,07
31240	T25	163	33	3/16"	6,20
31241	T27	176	36	7/32"	6,58
31242	T30	191	38	1/4"	7,19
31243	T40	210	43	5/16"	9,02
31244	T45	232	49	3/8"	10,08

## Llave Allen



### ProStar con cabeza esférica TORX®, acabado en oxidación negra

366BE

n° pdo.		mm			€/unid.
32386	T9	111	21	7/64"	4,39
32387	T10	121	23	1/8"	4,70
32388	T15	136	27	9/64"	4,89
32389	T20	148	29	5/32"	5,13
32390	T25	163	33	3/16"	5,45
32391	T27	176	36	7/32"	5,82
32392	T30	191	38	1/4"	6,32
32393	T40	210	43	5/16"	7,94
33749	T45	232	49	3/8"	9,49

Llave Allen



**TORX® con cabeza esférica, con brazo corto, plata titanio**

366BET

n° pdo.		mm				€/unid.
40966	T5	72	6.5	0,05"	10	5,31
40967	T6	80	6.9	1/16"	10	4,58
40968	T7	89	8.9	5/64"	10	4,58
40969	T8	101	10.4	3/32"	10	4,58
40970	T9	111	11.8	7/64"	10	5,22
40971	T10	122	12	1/8"	10	5,62
40972	T15	136	12.5	9/64"	10	5,86
40973	T20	149	13.3	5/32"	10	6,14
40974	T25	164.5	16.2	3/16"	10	6,54
40975	T27	176	18	7/32"	10	6,98
40976	T30	191	19.2	1/4"	10	7,58
40977	T40	210	24.1	5/16"	10	9,55
40978	T45	232	29.5	3/8"	10	12,82

TORX®, con cabeza esférica, a partir del tamaño T9

Llave Allen



**TORX®, acabado en oxidación negra**

366

n° pdo.		mm				€/unid.
24313	T5	72	13	0,05"	10	4,39
24314	T6	80	15	1/16"	10	3,81
24315	T7	88	18	5/64"	10	3,81
24316	T8	101	20	3/32"	10	3,81
24317	T9	111	21	7/64"	10	3,81
24318	T10	121	23	1/8"	10	4,10
24319	T15	136	26	9/64"	10	4,22
24320	T20	148	29	5/32"	10	4,39
24321	T25	163	33	3/16"	10	4,54
24322	T27	176	36	7/32"	10	4,84
24323	T30	191	38	1/4"	10	5,39
24324	T40	210	43	5/16"	10	6,63
24325	T50	232	49	3/8"	10	9,31

Llave Allen



**TORX® en plata titanio**

366TS

n° pdo.		mm				€/unid.
39106	T5	72	13	0,05"	10	4,70
39107	T6	80	15	1/16"	10	3,98
39108	T7	88	18	5/64"	10	3,98
39109	T8	101	20	3/32"	10	3,98
39110	T9	111	21	7/64"	10	3,98
39111	T10	121	23	1/8"	10	4,29
39112	T15	136	26	9/64"	10	4,41
39113	T20	148	29	5/32"	10	4,56
39114	T25	163	33	3/16"	10	4,73
39115	T27	176	36	7/32"	10	5,08
39116	T30	191	38	1/4"	10	5,59
39117	T40	210	43	5/16"	10	6,87
39118	T45	232	49	3/8"	10	9,62

Llave Allen



**TORX PLUS®, corta, acabado en oxidación negra**

361IP

n° pdo.		mm				€/unid.
24515	7IP	44	18	2.5	10	5,35
24517	8IP	47	18	2.5	10	5,35
24519	9IP	51	19	3	10	5,35
24521	10IP	54	20	3	10	5,46
24523	15IP	58	22	3.5	10	5,77
24525	20IP	62	23	4	10	5,89
24527	25IP	67	25	4.5	10	6,20
24529	27IP	73	27	5.5	10	6,43
24531	30IP	79	30	6	10	6,92
24533	40IP	88	33	7	10	7,89

Llave Allen



**TORX® , corta, acabado en oxidación negra**

363

n° pdo.						€/unid.
03764	T5	39	18	2.5	10	3,87
01310	T6	41	18	2.5	10	3,38
01311	T7	44	18	2.5	10	3,38
01312	T8	47	18	2.5	10	3,38
01313	T9	51	19	3	10	3,38
01314	T10	54	20	3	10	3,62
01315	T15	57	22	3.5	10	3,76
01316	T20	62	23	4	10	3,82
01317	T25	67	25	4.5	10	3,93
01318	T27	72	27	5.5	10	4,07
01319	T30	79	30	6	10	4,40
01320	T40	86	33	7	10	5,18
01321	T45	90	36	8	10	6,13
01322	T50	104	41	9	10	7,46
01323	T55	120	47	12	10	10,09
01324	T60	134	52	14	10	13,50

Llave Allen



**TORX® Tamper Resistant (con taladro) corta, acabado en oxidación negra**

363TR

n° pdo.						€/unid.
24107	T8H	47	18	2.5	10	4,30
24109	T9H	51	19	3	10	4,30
24111	T10H	54	20	3	10	4,70
24113	T15H	57	22	3.5	10	4,75
24115	T20H	62	23	4	10	4,88
24117	T25H	67	25	4.5	10	5,06
24119	T27H	72	27	5.5	10	5,27
24121	T30H	79	30	6	10	5,83
24123	T40H	86	33	7	10	7,00

Llave Allen con mango corredizo Comfort grip



hexagonal MagicRing® con acoplamiento lateral, en cromado mate

334DSR

n° pdo.							€/unid.
26135	3.0	100	13	80	26	10	8,52
26136	4.0	150	13	80	26	10	9,52
26137	5.0	150	17	100	32	10	10,41
26138	6.0	150	17	100	32	10	11,40
26139	8.0	200	17	100	32	10	14,42
26140	10.0	200	22	120	38	5	22,44

Llave Allen con mango corredizo Comfort grip



hexagonal con acoplamiento lateral, en cromado mate

334DSR

n° pdo.							€/unid.
26164	2.0	100	13	80	26	10	5,68
26165	2.5	100	13	80	26	10	5,81
26166	3.0	100	13	80	26	10	5,86
26167	4.0	150	13	80	26	10	6,25
26168	5.0	150	17	100	32	10	6,99
26169	6.0	150	17	100	32	10	7,86
26170	8.0	200	17	100	32	10	10,09
26171	10.0	200	22	120	38	5	16,95

Llave Allen con mango corredizo Comfort grip



hexagonales, de 6 unid., con acoplamiento lateral, en cromado mate

540DS

n° pdo.							€/unid.
28372	3.0	150	13	80	26	10	6,94
28373	4.0	150	13	80	26	10	7,54
28374	5.0	150	17	100	32	10	9,04
28375	6.0	150	17	100	32	10	10,64
28376	8.0	200	17	100	32	10	15,00
28377	10.0	200	22	120	38	5	20,08

Llave Allen con mango corredizo Comfort grip



TORX®, con acoplamiento lateral, en cromado mate

364DS

n° pdo.							€/unid.
26172	T10	100	13	80	26	10	12,03
26173	T15	100	13	80	26	10	12,38
26174	T20	100	17	100	32	10	13,37
26175	T25	150	17	100	32	10	13,62
26176	T27	150	17	100	32	10	13,86
26177	T30	150	17	100	32	10	14,00
26178	T40	150	17	100	32	10	14,61



Llave Allen con mango corredizo



hexagonal MagicRing®, en niquelado brillante

334R

n° pdo.			mm				€/unid.
22168	3.0	100	126	80	26	10	6,20
22170	4.0	150	176	80	26	10	7,14
22172	5.0	150	182	100	32	10	7,76
22174	6.0	150	182	100	32	10	8,37
21960	8.0	200	232	100	32	10	11,51
21962	10.0	200	238	120	38	10	17,78

Llave Allen con mango corredizo



hexagonal, en niquelado brillante

334

n° pdo.				mm				€/unid.
00904	2.0	100	126	80	26	10	4,34	
00905	2.0	200	226	80	26	10	5,84	
00906	2.5	100	126	80	26	10	4,43	
00907	2.5	200	226	80	26	10	6,03	
00908	3.0	100	126	80	26	10	4,28	
00909	3.0	150	176	80	26	10	4,59	
00910	3.0	200	226	80	26	10	5,47	
00911	3.0	350	382	100	32	10	11,71	
00912	4.0	100	126	80	26	10	4,34	
00913	4.0	150	176	80	26	10	4,78	
00914	4.0	200	226	80	26	10	5,47	
00915	4.0	350	382	100	32	10	11,71	
00916	5.0	100	132	100	32	10	4,73	
00917	5.0	150	182	100	32	10	5,21	
00918	5.0	200	232	100	32	10	6,15	
00919	5.0	350	382	100	32	10	10,57	
00921	6.0	100	132	100	32	10	5,47	
00922	6.0	150	182	100	32	10	6,03	
00923	6.0	200	232	100	32	10	6,72	
00924	6.0	350	382	100	32	10	11,56	
00926	7.0	200	232	100	32	10	8,09	
00928	8.0	100	132	100	32	10	6,72	
00929	8.0	150	182	100	32	10	7,33	
00930	8.0	200	232	100	32	10	7,94	
00931	8.0	350	382	100	32	10	12,56	
00933	10.0	100	138	120	38	10	11,19	
00934	10.0	200	238	120	38	10	13,56	
00937	12.0	200	238	120	38	5	17,53	

Llave Allen con mango corredizo



con cabeza esférica hexagonal, en niquelado brillante

540

n° pdo.			mm				€/unid.
04111	4.0	150	176	80	26	10	6,20
04108	5.0	150	182	100	32	10	8,51
04105	6.0	150	182	100	32	10	9,89
04099	8.0	200	238	100	32	10	14,46
04096	10.0	200	238	120	38	10	18,15

Llave de vaso con mango corredizo



hexagonal, en niquelado brillante

336

n° pdo.			mm				€/unid.
00965	5.5	125	157	100	32	10	10,88
00966	6.0	125	157	100	32	10	11,01
00967	6.0	200	232	100	32	10	14,75
00968	7.0	125	157	100	32	10	12,02
00969	7.0	200	232	100	32	10	14,75
00971	8.0	125	157	100	32	10	12,26
00972	8.0	200	232	100	8	10	15,13
00973	8.0	350	382	100	32	10	16,28
00974	9.0	125	157	100	32	10	13,25
00975	9.0	200	232	100	32	10	15,90
00977	10.0	125	157	100	32	10	13,01
00978	10.0	200	232	100	32	10	16,14
00980	10.0	350	382	100	32	5	17,90
00982	11.0	125	157	100	32	10	15,02
00983	11.0	230	262	100	32	5	19,01
00985	12.0	125	157	100	32	10	15,90
00986	12.0	230	262	100	32	5	20,51
00988	13.0	125	157	100	32	10	17,39
00989	13.0	230	262	100	32	10	20,77
00990	13.0	350	382	100	32	5	22,51
00991	14.0	125	157	100	32	5	19,15
00993	15.0	125	157	100	32	5	21,52
00994	16.0	125	157	100	32	5	23,27
00995	17.0	125	157	100	32	5	24,14

Llave de vaso con mango corredizo

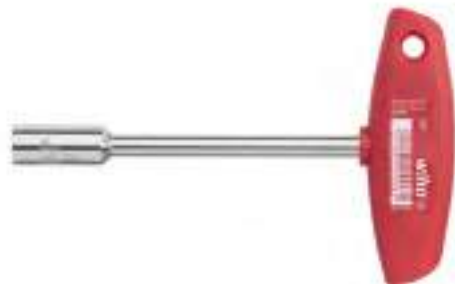

cuadrado

338

n° pdo.			mm				€/unid.
01005	6	125	157	100	32	10	15,90
01006	8	125	157	100	32	10	17,26
01007	10	125	157	100	32	10	19,89
01008	12	125	157	100	32	10	22,39

Llave Allen con mango corredizo



hexagonal, en versión en pulgadas, en niquelado brillante

334Z

n° pdo.			mm				€/unid.
02802	3/32"	150	176	80	26	10	5,70
02803	7/64"	150	176	80	26	10	5,82
02804	1/8"	150	176	80	26	10	5,88
02805	9/64"	150	176	80	26	10	5,94
02806	5/32"	150	176	80	26	10	6,02
02807	3/16"	150	182	100	32	10	6,13
02808	7/32"	150	182	100	32	10	7,01
02809	1/4"	150	182	100	32	10	7,26
02810	5/16"	150	182	100	32	10	7,88
02811	3/8"	150	188	120	38	10	13,76

Llave de vaso con mango corredizo



hexagonal, en versión en pulgadas, en niquelado brillante

336Z

n° pdo.								€/unid.
02819	3/16"	150	182	100	32	4.8	10	12,33
02820	1/4"	150	182	100	32	6.4	10	13,15
02821	5/16"	150	182	100	32	7.9	10	13,79
02822	3/8"	150	182	100	32	9.5	10	15,11
02823	7/16"	150	182	100	32	11.1	10	18,68
02824	1/2"	150	182	100	32	12.7	10	20,44

Llave de vaso con mango corredizo



hexagonal

336N

n° pdo.							€/unid.
27932	8.0	200	232	100	32	10	28,78
27933	10.0	230	262	100	32	10	31,39
27934	13.0	230	262	100	32	10	34,40
27935	17.0	230	268	120	38	10	37,41

Fabricado de acuerdo con IEC 60900.

Llave Allen con mango corredizo electric



hexagonal

334N

n° pdo.							€/unid.
27928	4.0	150	176	80	26	10	10,14
27929	5.0	150	182	100	32	10	11,38
27930	6.0	150	182	100	32	10	12,63
27931	8.0	150	182	100	32	10	14,64

Fabricado de acuerdo con IEC 60900.

Llave Allen con mango corredizo



**TORX®**, en cromado mate

364

n° pdo.				mm				€/unid.
01328	T9	100	4	126	80	26	10	9,37
01329	T10	100	4	126	80	26	10	9,63
01330	T15	100	4	126	80	26	10	9,74
01331	T15	200	5.5	226	80	26	10	12,39
01332	T20	100	4	132	100	32	10	10,63
01333	T20	200	5.5	232	100	32	10	13,64
01334	T25	100	4.5	132	100	32	10	10,88
01335	T25	200	5.5	232	100	32	10	14,14
01336	T27	100	5.5	132	100	32	10	11,14
01337	T27	200	5.5	232	100	32	5	14,51
01338	T30	100	6	132	100	32	10	11,38
01339	T30	200	6	232	100	32	5	15,27
01340	T40	100	7	132	100	32	10	12,13
01341	T40	200	7	232	100	32	5	16,63
01343	T45	250	8	288	120	38	5	21,52
01345	T50	250	9	288	120	38	5	24,65

Llave Allen con mango corredizo



**TORX PLUS®**, en cromado mate

364IP

n° pdo.				mm				€/unid.
26953	9IP	100	4	126	80	26	10	13,23
26954	10IP	100	4	126	80	26	10	13,73
26955	15IP	100	4	126	80	26	10	14,09
26956	20IP	100	4	132	100	32	10	14,97
26957	25IP	150	4.5	182	100	32	10	16,63
26958	27IP	150	5.5	182	100	32	10	17,25
26959	30IP	150	6	182	100	32	10	18,34
26960	40IP	150	7	182	100	32	10	19,67

Llave Allen con mango corredizo



**TORX® MagicSpring®**, en cromado mate

364R

n° pdo.				mm				€/unid.
27964	T9	100	4	126	80	26	10	12,27
27965	T10	100	4	126	80	26	10	12,89
27966	T15	100	4	126	80	26	10	13,01
27967	T20	100	4	132	100	32	10	14,02
27968	T25	100	5	132	100	32	10	14,02
27970	T30	100	6	132	100	32	10	15,10
27971	T40	100	8	132	100	32	10	16,14

Llave Allen con mango de llave

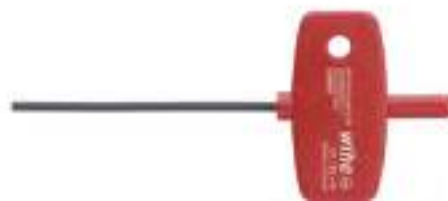

**hexagonal**, acabado en oxidación negra

331

n° pdo.			mm			€/unid.
00894	1.5	60	95	40	10	4,12
00895	2.0	60	95	40	10	4,05
00896	2.5	60	95	40	10	3,99
00897	3.0	60	95	40	10	3,99

Llave Allen con mango de llave



TORX®, acabado en oxidación negra

365

n° pdo.				mm			€/unid.
04918	T5	35	2	70	40	10	4,91
01350	T6	35	2	70	40	10	4,91
01351	T7	35	2.5	70	40	10	4,91
01352	T8	40	2.5	75	40	10	4,91
01353	T9	40	3	75	40	10	5,39
01354	T10	40	3	75	40	10	5,55
01355	T15	45	3.5	80	40	10	5,75
01356	T20	45	4	80	40	10	6,29

Llave Allen con mango de bandera



TORX®, acabado en oxidación negra

370

n° pdo.				mm			€/unid.
03724	T5	35	2	62	15	10	4,91
03725	T6	35	2	62	15	10	4,91
03726	T7	35	2.5	67	19	10	4,91
03727	T8	40	2.5	72	19	10	4,91
03728	T9	40	3	74	24	10	5,39
03729	T10	40	3	74	24	10	5,55
03730	T15	45	3.5	80	28	10	5,75
03731	T20	45	4	80	28	10	6,29

Llave Allen con mango de llave



TORX®, acabado en oxidación negra

365IP

n° pdo.				mm			€/unid.
26181	5IP		2	70	40	10	7,84
26182	6IP		2	70	40	10	7,84
26183	7IP		2.5	70	40	10	7,84
26184	8IP		2.5	75	40	10	7,84
26185	9IP		3	75	40	10	8,45
26186	10IP		3	75	40	10	8,60
26187	15IP		3.5	80	40	10	8,98
26188	20IP		4	80	40	10	10,08

Llave Allen con mango de bandera



TORX PLUS®, acabado en oxidación negra

370IP

n° pdo.				mm			€/unid.
27614	5IP	35	2	67	15	10	7,84
27615	6IP	35	2	67	15	10	7,84
27616	7IP	35	2.5	67	19	10	7,84
27617	8IP	40	2.5	72	19	10	7,84
27618	9IP	40	3	74	24	10	8,45
27619	10IP	40	3	74	24	10	8,60
27620	15IP	45	3.5	80	28	10	8,98
27621	20IP	45	4	80	28	10	10,21



## Bits

### Tres bits para todos los casos.

¿Qué máquina, qué aplicación, qué bit? El concepto de bit revolucionario de Wiha pone fin a todas las dudas y presenta tres tipos de bits que permiten cubrir todos los ámbitos de aplicación.

Únicamente la forma del tornillo es decisiva para la elección del bit. El bit Y es adecuado para el atornillado de tornillos en forma de Y con un ángulo de  $\neq 90^\circ$  entre la rosca y la cabeza del tornillo. Para los tornillos en forma de T con un ángulo de  $90^\circ$  se utiliza el bit T. Si es necesario atornillar las dos variantes de tornillos, la elección correcta es el bit TY, ya que como multitallento es adecuado para todos los tipos de atornillados.

La selección de caja de bits variadas facilita el uso ideal de los bits, como el BitBuddy® y el XLSelector, así como el portabits.

Para todos los tipos de tornillos

**Juego de bits BitBuddy®**, bits en TY de 49 mm Pozidriv de 8 unid. de 1/4" E6,3  
Página 232



**Juego de bits BitBuddy®**, bits en TY de 29 mm Pozidriv de 9 unid. de 1/4" C6,3  
Página 234



**bit TY de 49 mm Phillips (PH1)**, de 5 unid., de 1/4" E6,3 en caja  
Página 233



**Juego de bits, bit TY de 29 mm Phillips (PH1)**, de 5 unid., de 1/4" C6,3 en caja  
Página 235



Para tornillo en forma de T

**Juego de bits XLSelector**, bits en T de 25 mm Phillips, TORX®, hexagonal de 32 unid. de 1/4" C6,3  
Página 236



**Juego de bits FlipSelector**, bits en T de 25 mm hexagonal, de 14 unid. de 1/4" C6,3  
Página 236



**Juego de bits, bit T de 50 mm Phillips (PH1)**, de 5 unid., de 1/4" E6,3 en caja  
Página 237



**Juego de bits, bit T de 25 mm Phillips (PH1)**, de 5 unid., de 1/4" C6,3 en caja  
Página 237



Para tornillo en forma de Y

**Juego de bits XLSelector**, bits en Y de 25 mm TORX®, de 32 unid. de 1/4" C6,3  
Página 238



**Juego de bits FlipSelector**, bits en Y de 25 mm Pozidriv de 14 unid. de 1/4" C6,3  
Página 239



**Juego de bits, bit Y de 50 mm Phillips (PH1)**, de 5 unid., de 1/4" E6,3 en caja  
Página 239



**Juego de bits, bit Y de 25 mm Phillips (PH1)**, de 5 unid., de 1/4" C6,3 en caja  
Página 240



Para aplicaciones universales

**Juego de bits XLSelector Standard** de 25 mm en surtido, de 32 unid. de 1/4" C6,3  
Página 241



**Juego de bits FlipSelector Standard** de 25 mm SIT (para tornillos Assy® y Pias), de 15 unid., de 1/4" C6,3, con clip para el cinturón, en blister  
Página 242



**Bit Standard** de 25 mm ranurado de 1/4" C6,3  
Página 246



**Bit Professional** ranurado de 1/4" E6,3  
Página 250



Micro bits

**Juego de micro bits ESD** en surtido, de 66 unid., incl. caja  
Página 254



**Micro bit de 28 mm ranurado con forma de C4** 4 mm  
Página 255



Portabits

**Portabits Porta-Puntas con bloqueo mecánico** 1/4", magnético en caja  
Página 260



**Portabits Porta-Puntas Super Slim con bloqueo mecánico** 1/4" en caja  
Página 260



**Portabits MagicFlip Force magnético con imán anular**, de 1/4" en caja  
Página 260



Soluciones especiales

**Juego de bits de macho de roscar, combinado** 1/4" 6 unid., incl. caja  
Página 257



**Bit de avellanador cónico de 1/4"**  
Página 257



**Destornillador con portabits SoftFinish® Porta-Puntas con bloqueo mecánico de 1/4"**  
Página 263





**Pozidriv de 8 unid. de 1/4" E6,3** SB7946TY202

n° pdo.	
42099	6
	1 x TY-Bit 49 mm Pozidriv 1/4" PZ1 / 5 x TY-Bit 49 mm Pozidriv 1/4" PZ2 / 1 x TY-Bit 49 mm Pozidriv 1/4" PZ3
	1 x BitBuddy®

en comparación con el Standard-Bit de Wiha

**TORX®, de 8 unid. de 1/4" E6,3** SB7946TY505

n° pdo.	
42115	6
	1 x TY-Bit 49 mm TORX® 1/4" / 1 x TY-Bit 49 mm TORX® 1/4" / 2 x TY-Bit 49 mm TORX® 1/4" / 1 x TY-Bit 49 mm TORX® 1/4" / 1 x TY-Bit 49 mm TORX® 1/4" / 1 x TY-Bit 49 mm TORX® 1/4"
	1 x BitBuddy®

\* en comparación con el Standard-Bit de Wiha  
en comparación con el Standard-Bit de Wiha

**hexagonales, de 8 unid. de 1/4" E6,3** SB7946TY303

n° pdo.	
42114	6
	2 x TY-Bit 49 mm hexagonal 1/4" SW3 / 2 x TY-Bit 49 mm hexagonal 1/4" SW4 / 2 x TY-Bit 49 mm hexagonal 1/4" SW5 / 1 x TY-Bit 49 mm hexagonal 1/4" SW6
	1 x BitBuddy®

\* en comparación con el Standard-Bit de Wiha  
en comparación con el Standard-Bit de Wiha

**Phillips, Pozidriv, TORX®, de 8 unid. de 1/4" E6,3** SB7946TY903

n° pdo.		€/unid.
42116	6	42,72
	1 x TY-Bit 49 mm Phillips 1/4"	
	1 x TY-Bit 49 mm Pozidriv 1/4" PZ1 / 1 x TY-Bit 49 mm Pozidriv 1/4" PZ2 / 1 x TY-Bit 49 mm Pozidriv 1/4" PZ3	
	1 x TY-Bit 49 mm TORX® 1/4" / 1 x TY-Bit 49 mm TORX® 1/4" / 1 x TY-Bit 49 mm TORX® 1/4"	
	1 x BitBuddy®	

\* en comparación con el Standard-Bit de Wiha  
en comparación con el Standard-Bit de Wiha

**Phillips, Pozidriv, TORX®, de 8 unid. de 1/4" E6,3** SB7946TY904

n° pdo.		€/unid.
42117	6	42,72
	1 x TY-Bit 49 mm Phillips 1/4"	
	1 x TY-Bit 49 mm Pozidriv 1/4" PZ1 / 1 x TY-Bit 49 mm Pozidriv 1/4" PZ2	
	1 x TY-Bit 49 mm TORX® 1/4" / 1 x TY-Bit 49 mm TORX® 1/4" / 1 x TY-Bit 49 mm TORX® 1/4"	
	1 x BitBuddy®	

\* en comparación con el Standard-Bit de Wiha  
en comparación con el Standard-Bit de Wiha

**Pozidriv, TORX®, de 8 unid. de 1/4" E6,3** SB7946TY905

n° pdo.		€/unid.
42118	6	42,72
	1 x TY-Bit 49 mm Pozidriv 1/4" PZ2 / 1 x TY-Bit 49 mm Pozidriv 1/4" PZ3	
	1 x TY-Bit 49 mm TORX® 1/4" / 1 x TY-Bit 49 mm TORX® 1/4" / 1 x TY-Bit 49 mm TORX® 1/4" / 1 x TY-Bit 49 mm TORX® 1/4"	
	1 x BitBuddy®	

\* en comparación con el Standard-Bit de Wiha  
en comparación con el Standard-Bit de Wiha



bit TY de 49 mm



5 unid., de 1/4" E6,3 en caja

n° pdo.			€/unid.
42097	5 x PH1	6	22,82
42119	5 x PH2	6	22,82
42120	5 x PH3	6	22,82
42121	5 x PZ1	6	22,82
42122	5 x PZ2	6	22,82
42123	5 x PZ3	6	22,82
42124	5 x SW3	6	23,73
42125	5 x SW4	6	23,73
42126	5 x SW5	6	23,73
42127	5 x SW6	6	23,73
42128	5 x T10	6	23,73
42129	5 x T15	6	23,73
42130	5 x T20	6	23,73
42131	5 x T25	6	23,73
42132	5 x T27	6	23,73
42133	5 x T30	6	23,73
42134	5 x T40	6	23,73

\* en comparación con el Standard-Bit de Wiha

## CUADRO INFORMATIVO: BitBuddy 29

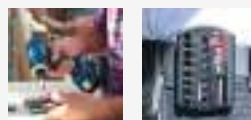

### Manejo sencillo con una sola mano

Alojar:

Alojamiento directo de los bits con la máquina en el BitBuddy.

Trabajar:

Realización de los atornillados.

Guardar:

- Introducción sencilla de los bits de nuevo en el BitBuddy presionando sobre la barra de bits roja.
- Con portabits magnético para el cambio de bit rápido.
- BitBuddy siempre está listo para el uso, cabe en el bolsillo del pantalón o en el clip para el cinturón.



**TORX®, de 9 unid. de 1/4" C6,3**

SB7945TY505

n° pdo.		€/unid.
42136	6	35,95
	1 x TY-Bit 29 mm TORX® 1/4" / 1 x TY-Bit 29 mm TORX® 1/4" / 1 x TY-Bit 29 mm TORX® 1/4" / 1 x TY-Bit 29 mm TORX® 1/4" / 1 x TY-Bit 29 mm TORX® 1/4" / 1 x TY-Bit 29 mm TORX® 1/4"	
	1 x Portabits magnético 60 mm 1/4" imán extra fuerte de en caja	
	1 x BitBuddy®	

\* en comparación con el Standard-Bit de Wiha

**Phillips, Pozidriv, TORX®, de 9 unid. de 1/4" C6,3**

SB7945TY904

n° pdo.		€/unid.
42138	6	35,95
	1 x TY-Bit 29 mm Phillips 1/4" PH2	
	1 x TY-Bit 29 mm Pozidriv 1/4" PZ1 / 1 x TY-Bit 29 mm Pozidriv 1/4" PZ1	
	1 x TY-Bit 29 mm TORX® 1/4" / 1 x TY-Bit 29 mm TORX® 1/4" / 1 x TY-Bit 29 mm TORX® 1/4" / 1 x TY-Bit 29 mm TORX® 1/4"	
	1 x Portabits magnético 60 mm 1/4" imán extra fuerte de en caja	
	1 x BitBuddy®	

\* en comparación con el Standard-Bit de Wiha

**hexagonales, de 9 unid. de 1/4" C6,3**

SB7945TY303

n° pdo.		€/unid.
42135	6	35,95
	2 x TY-Bit 29 mm hexagonal 1/4" / 2 x TY-Bit 29 mm hexagonal 1/4" / 2 x TY-Bit 29 mm hexagonal 1/4" / 1 x TY-Bit 29 mm hexagonal 1/4"	
	1 x Portabits magnético 60 mm 1/4" imán extra fuerte de en caja	
	1 x BitBuddy®	

\* en comparación con el Standard-Bit de Wiha

**Pozidriv, TORX®, de 9 unid. de 1/4" C6,3**

SB7945TY905

n° pdo.		€/unid.
42139	6	35,95
	1 x TY-Bit 29 mm Pozidriv 1/4" PZ1 / 1 x TY-Bit 29 mm Pozidriv 1/4" PZ3	
	1 x TY-Bit 29 mm TORX® 1/4" / 1 x TY-Bit 29 mm TORX® 1/4" / 1 x TY-Bit 29 mm TORX® 1/4" / 1 x TY-Bit 29 mm TORX® 1/4"	
	1 x Portabits magnético 60 mm 1/4" imán extra fuerte de en caja	
	1 x BitBuddy®	

\* en comparación con el Standard-Bit de Wiha

**Phillips, Pozidriv, TORX®, de 9 unid. de 1/4" C6,3**

SB7945TY903

n° pdo.		€/unid.
42137	6	35,95
	1 x TY-Bit 29 mm Phillips 1/4" PH2	
	1 x TY-Bit 29 mm Pozidriv 1/4" PZ1 / 1 x TY-Bit 29 mm Pozidriv 1/4" PZ1 / TY-Bit 29 mm Pozidriv 1/4" PZ3	
	1 x TY-Bit 29 mm TORX® 1/4" / 1 x TY-Bit 29 mm TORX® 1/4" / 1 x TY-Bit 29 mm TORX® 1/4"	
	1 x Portabits magnético 60 mm 1/4" imán extra fuerte de en caja	
	1 x BitBuddy®	

\* en comparación con el Standard-Bit de Wiha

**Pozidriv de 9 unid. de 1/4" C6,3**

SB7945TY202

n° pdo.		€/unid.
42098	6	35,15
	1 x TY-Bit 29 mm Pozidriv 1/4" PZ1 / 5 x TY-Bit 29 mm Pozidriv 1/4" PZ1 / 1 x TY-Bit 29 mm Pozidriv 1/4" PZ3	
	1 x Portabits magnético 60 mm 1/4" imán extra fuerte de en caja	
	1 x BitBuddy®	

\* en comparación con el Standard-Bit de Wiha

Juego de bits, bit TY de 29 mm



de 5 unid., de 1/4" C6,3 en caja

n° pdo.			€/unid.
42096	5 x PH1	6	14,87
42100	5 x PH2	6	14,87
42101	5 x PH3	6	14,87
42149	5 x PZ1	6	14,87
42102	5 x PZ2	6	14,87
42103	5 x PZ3	6	14,87
42104	5 x SW3	6	16,43
42105	5 x SW4	6	16,43
42106	5 x SW5	6	16,43
42107	5 x SW6	6	16,43
42108	5 x T10	6	16,43
42109	5 x T15	6	16,43
42110	5 x T20	6	16,43
42111	5 x T25	6	16,43
42112	5 x T27	6	16,43
42113	5 x T30	6	16,43
42150	5 x T40	6	16,43

\* en comparación con el Standard-Bit de Wiha

de 25 unid., 1/4" C6,3 en caja

n° pdo.			€/unid.
42539	25 x PH2	1	74,36
42551	25 x PZ2	1	74,36
42548	25 x T20	1	82,12
42549	25 x T25	1	82,12
42550	25 x T30	1	82,12

\* en comparación con el Standard-Bit de Wiha

CUADRO INFORMATIVO:  
Concepto de bit TY de  
Wiha



- Elección de los bits rápida y sencilla mediante la forma de la cabeza del tornillo.
- El bit T es ideal para el atornillado de tornillos en forma de T con un ángulo de 90 °.
- El bit Y es ideal para el atornillado de tornillos en forma de Y con un ángulo diferente a 90 °.
- El bit TY es un multitalento y es adecuado para todos los tipos de tornillos, ya sea con cabeza del tornillo en forma de Y o de T.

**Juego de bits XLSelector, bits en T de 50 mm**



**Phillips, TORX®, hexagonal de 14 unid. de 1/4" E6,3**

SB7948T950

n° pdo.	📦	€/unid.
41831	6	57,60
+	1 x T-Bit 50 mm Phillips 1/4" PH1 / 1 x T-Bit 50 mm Phillips 1/4" PH2 / 1 x T-Bit 50 mm Phillips 1/4" PH3	
⊕	1 x T-Bit 50 mm TORX® 1/4" T15 / 1 x T-Bit 50 mm TORX® 1/4" T20 / 1 x T-Bit 50 mm TORX® 1/4" T25 / 1 x T-Bit 50 mm TORX® 1/4" T30 / 1 x T-Bit 50 mm TORX® 1/4" T40	
●	1 x T-Bit 50 mm hexagonal de 1/4" SW3 / 1 x T-Bit 50 mm hexagonal de 1/4" SW4 / 1 x T-Bit 50 mm hexagonal de 1/4" SW5 / 1 x T-Bit 50 mm hexagonal de 1/4" SW6	
○	1 x Portabits magnético 58 mm de 1/4"	
	1 x XLSelector	

\* en comparación con el Standard-Bit de Wiha

**Juego de bits XLSelector, bits en T de 25 mm**



**Phillips, TORX®, hexagonal de 32 unid. de 1/4" C6,3**

SB7948T999

n° pdo.	📦	€/unid.
41830	6	68,55
+	2 x T-Bit 25 mm Phillips PH1 1/4" / 4 x T-Bit 25 mm Phillips 1/4" PH2 / 2 x T-Bit 25 mm Phillips 1/4" PH3	
⊕	2 x T-Bit 25 mm TORX® 1/4" T10 / 2 x T-Bit 25 mm TORX® 1/4" T15 / 4 x T-Bit 25 mm TORX® 1/4" T20 / 2 x T-Bit 25 mm TORX® 1/4" T25 / 2 x T-Bit 25 mm TORX® 1/4" T30 / 2 x T-Bit 25 mm TORX® 1/4" T40	
●	2 x T-Bit 25 mm hexagonal de 1/4" SW3 / 2 x T-Bit 25 mm hexagonal de 1/4" SW4 / 2 x T-Bit 25 mm hexagonal de 1/4" SW5 / 2 x T-Bit 25 mm hexagonal de 1/4" SW6	
○	1 x Portabits magnético 58 mm de 1/4"	
	1 x XLSelector	

\* en comparación con el Standard-Bit de Wiha

**Juego de bits FlipSelector, bits en T de 25 mm**



**hexagonal, de 14 unid. de 1/4" C6,3**

SB7947T303

n° pdo.	📦	€/unid.
41825	6	31,54
●	3 x T-Bit 25 mm hexagonal de 1/4" SW3 / 3 x T-Bit 25 mm hexagonal de 1/4" SW4 / 3 x T-Bit 25 mm hexagonal de 1/4" SW5 / 3 x T-Bit 25 mm hexagonal de 1/4" SW6	
○	1 x Portabits magnético 58 mm de 1/4"	
	1 x FlipSelector	

\* en comparación con el Standard-Bit de Wiha

**Phillips, Pozidriv, TORX®, de 14 unid. de 1/4" C6,3**

SB7947T906

n° pdo.	📦	€/unid.
41824	6	31,54
+	1 x T-Bit 25 mm Phillips PH1 1/4" / 3 x T-Bit 25 mm Phillips 1/4" PH2 / 1 x T-Bit 25 mm Phillips 1/4" PH3	
⊕	1 x T-Bit 25 mm Pozidriv 1/4" PZ2	
⊕	1 x T-Bit 25 mm TORX® 1/4" T10 / 1 x T-Bit 25 mm TORX® 1/4" T15 / 1 x T-Bit 25 mm TORX® 1/4" T20 / 1 x T-Bit 25 mm TORX® 1/4" T25 / 1 x T-Bit 25 mm TORX® 1/4" T30 / 1 x T-Bit 25 mm TORX® 1/4" T40	
○	1 x Portabits magnético 58 mm de 1/4"	
	1 x FlipSelector	

\* en comparación con el Standard-Bit de Wiha

**en surtido, de 14 unid. de 1/4" C6,3**

SB7947T999

n° pdo.	📦	€/unid.
41826	6	31,54
+	1 x T-Bit 25 mm Phillips PH1 1/4" / 1 x T-Bit 25 mm Phillips 1/4" PH2 / 1 x T-Bit 25 mm Phillips 1/4" PH3	
⊕	1 x T-Bit 25 mm Pozidriv 1/4" PZ2	
⊕	1 x T-Bit 25 mm TORX® 1/4" T15 / 1 x T-Bit 25 mm TORX® 1/4" T20 / 1 x T-Bit 25 mm TORX® 1/4" T25 / 1 x T-Bit 25 mm TORX® 1/4" T30 / 1 x T-Bit 25 mm TORX® 1/4" T40	
●	1 x T-Bit 25 mm hexagonal de 1/4" SW4 / 1 x T-Bit 25 mm hexagonal de 1/4" SW5 / 1 x T-Bit 25 mm hexagonal de 1/4" SW6	
○	1 x Portabits magnético 58 mm de 1/4"	
	1 x FlipSelector	

\* en comparación con el Standard-Bit de Wiha

Juego de bits, bit T de 50 mm



de 5 unid., de 1/4" E6,3 en caja

n° pdo.			€/unid.
41637	⊕ 5 x PH1	6	21,13
41638	⊕ 5 x PH2	6	21,13
41639	⊕ 5 x PH3	6	21,13
41640	⊗ 5 x PZ1	6	21,13
41641	⊗ 5 x PZ2	6	21,13
41642	⊗ 5 x PZ3	6	21,13
41650	● 5 x SW3	6	21,13
41651	● 5 x SW4	6	21,13
41652	● 5 x SW5	6	21,13
41653	● 5 x SW6	6	21,13
41643	⊛ 5 x T10	6	21,13
41644	⊛ 5 x T15	6	21,13
41645	⊛ 5 x T20	6	21,13
41646	⊛ 5 x T25	6	21,13
41648	⊛ 5 x T30	6	21,13
41649	⊛ 5 x T40	6	21,13
41660	■ 5 x #1	6	21,13
41662	■ 5 x #2	6	21,13
41663	■ 5 x #3	6	21,13

\* en comparación con el Standard-Bit de Wiha

Juego de bits, bit T de 25 mm



de 5 unid., de 1/4" C6,3 en caja

n° pdo.			€/unid.
41598	⊕ 5 x PH1	6	10,28
41599	⊕ 5 x PH2	6	10,28
41600	⊕ 5 x PH3	6	10,28
41601	⊗ 5 x PZ1	6	10,28
41602	⊗ 5 x PZ2	6	10,28
41603	⊗ 5 x PZ3	6	10,28
41611	● 5 x SW3	6	10,28
41612	● 5 x SW4	6	10,28
41613	● 5 x SW5	6	10,28
41614	● 5 x SW6	6	10,28
41604	⊛ 5 x T10	6	10,28
41605	⊛ 5 x T15	6	10,28
41606	⊛ 5 x T20	6	10,28
41607	⊛ 5 x T25	6	10,28
41609	⊛ 5 x T30	6	10,28
41610	⊛ 5 x T40	6	10,28
41621	■ 5 x #1	6	10,28
41622	■ 5 x #2	6	10,28
41623	■ 5 x #3	6	10,28

\* en comparación con el Standard-Bit de Wiha

de 25 unid., 1/4" C6,3 en caja

n° pdo.			€/unid.
42292	⊕ 25 x PH2	1	51,42
42293	⊗ 25 x PZ2	1	51,42
42301	⊛ 25 x T20	1	51,42
42306	⊛ 25 x T25	1	51,42
42302	⊛ 25 x T30	1	51,42

\* en comparación con el Standard-Bit de Wiha

Juego de bits XLSelector, bits en Y de 50 mm



Phillips, Pozidriv, TORX®, de 14 unid. de 1/4" E6,3		SB7948Y950
n° pdo.		€/unid.
41834	6	57,60
⊕	2 x Y-Bit 50 mm Pozidriv 1/4" PH2	
⊕	1 x Y-Bit 50 mm Pozidriv 1/4" PZ1 / 2 x Y-Bit 50 mm Pozidriv 1/4" PZ2 / 1 x Y-Bit 50 mm Pozidriv 1/4" PZ3	
⊕	1 x Y-Bit 50 mm TORX® 1/4" T10 / 1 x Y-Bit 50 mm TORX® 1/4" T15 / 1 x Y-Bit 50 mm TORX® 1/4" T20 / 1 x Y-Bit 50 mm TORX® 1/4" T25 / 1 x Y-Bit 50 mm TORX® 1/4" T30 / 1 x Y-Bit 50 mm TORX® 1/4" T40	
○	1 x Portabits magnético 58 mm de 1/4"	
	1 x XLSelector	

\* en comparación con el Standard-Bit de Wiha

Juego de bits XLSelector, bits en Y de 25 mm



TORX®, de 32 unid. de 1/4" C6,3		SB7948Y505
n° pdo.		€/unid.
41833	6	68,55
⊕	3 x Y-Bit 25 mm TORX® 1/4" T10 / 6 x Y-Bit 25 mm TORX® 1/4" T15 / 6 x Y-Bit 25 mm TORX® 1/4" T20 / 6 x Y-Bit 25 mm TORX® 1/4" T25 / 6 x Y-Bit 25 mm TORX® 1/4" T30 / 3 x Y-Bit 25 mm TORX® 1/4" T40	
○	1 x Portabits magnético 58 mm de 1/4"	
	1 x XLSelector	

\* en comparación con el Standard-Bit de Wiha

Phillips, Pozidriv, TORX®, de 32 unid. de 1/4" C6,3		SB7948Y904
n° pdo.		€/unid.
41832	6	68,55
⊕	1 x Y-Bit 25 mm Phillips 1/4" PH1 / 4 x Y-Bit 25 mm Phillips 1/4" PH2 / 1 x Y-Bit 25 mm Phillips 1/4" PH3	
⊕	2 x Y-Bit 25 mm Pozidriv 1/4" PZ1 / 4 x Y-Bit 25 mm Pozidriv 1/4" PZ2 / 2 x Y-Bit 25 mm Pozidriv 1/4" PZ3	
⊕	2 x Y-Bit 25 mm TORX® 1/4" T10 / 3 x Y-Bit 25 mm TORX® 1/4" T15 / 3 x Y-Bit 25 mm TORX® 1/4" T20 / 3 x Y-Bit 25 mm TORX® 1/4" T25 / 3 x Y-Bit 25 mm TORX® 1/4" T30 / 2 x Y-Bit 25 mm TORX® 1/4" T40	
○	1 x Portabits magnético 58 mm de 1/4"	
	1 x XLSelector	

\* en comparación con el Standard-Bit de Wiha

Juego de bits FlipSelector, bits en Y de 25 mm



**Pozidriv de 14 unid. de 1/4" C6,3**

SB7947Y202

n° pdo.	📦	€/unid.
41829	6	31,54

- ⊕ 2 x Y-Bit 25 mm Pozidriv 1/4" PZ1 / 8 x Y-Bit 25 mm Pozidriv 1/4" PZ2 / 2 x Y-Bit 25 mm Pozidriv 1/4" PZ3
- 1 x Portabits magnético 60 mm 1/4" imán extra fuerte de en caja
- 1 x FlipSelector

\* en comparación con el Standard-Bit de Wiha

**TORX®, de 14 unid. de 1/4" C6,3**

SB7947Y505

n° pdo.	📦	€/unid.
41828	6	31,54

- ⊕ 2 x Y-Bit 25 mm TORX® 1/4" T10 / 2 x Y-Bit 25 mm TORX® 1/4" T15 / 3 x Y-Bit 25 mm TORX® 1/4" T20 / 2 x Y-Bit 25 mm TORX® 1/4" T25 / 2 x Y-Bit 25 mm TORX® 1/4" T30 / 1 x Y-Bit 25 mm TORX® 1/4" T40
- 1 x Portabits magnético 60 mm 1/4" imán extra fuerte de en caja
- 1 x FlipSelector

\* en comparación con el Standard-Bit de Wiha

**Phillips, Pozidriv, TORX®, de 14 unid. de 1/4" C6,3**

SB7947Y904

n° pdo.	📦	€/unid.
41827	6	31,54

- ⊕ 1 x Y-Bit 25 mm Phillips 1/4" PH2
- ⊕ 1 x Y-Bit 25 mm Pozidriv 1/4" PZ1 / 2 x Y-Bit 25 mm Pozidriv 1/4" PZ2 / 1 x Y-Bit 25 mm Pozidriv 1/4" PZ3
- ⊕ 1 x Y-Bit 25 mm TORX® 1/4" T10 / 1 x Y-Bit 25 mm TORX® 1/4" T15 / 1 x Y-Bit 25 mm TORX® 1/4" T20 / 1 x Y-Bit 25 mm TORX® 1/4" T25 / 1 x Y-Bit 25 mm TORX® 1/4" T30 / 1 x Y-Bit 25 mm TORX® 1/4" T40
- 1 x Portabits magnético 60 mm 1/4" imán extra fuerte de en caja
- 1 x FlipSelector

\* en comparación con el Standard-Bit de Wiha

Juego de bits, bit Y de 50 mm



de 5 unid., de 1/4" E6,3 en caja

n° pdo.	📦	€/unid.
41624	6	21,13
41625	6	21,13
41626	6	21,13
41627	6	21,13
41628	6	21,13
41629	6	21,13
41630	6	21,13
41631	6	21,13
41632	6	21,13
41633	6	21,13
41635	6	21,13
41636	6	21,13

\* en comparación con el Standard-Bit de Wiha

## Juego de bits, bit Y de 25 mm



### de 5 unid., de 1/4" C6,3 en caja

n° pdo.			€/unid.
41585	5 x PH1	6	10,28
41586	5 x PH2	6	10,28
41587	5 x PH3	6	10,28
41588	5 x PZ1	6	10,28
41589	5 x PZ2	6	10,28
41590	5 x PZ3	6	10,28
41591	5 x T10	6	10,28
41592	5 x T15	6	10,28
41593	5 x T20	6	10,28
41594	5 x T25	6	10,28
41596	5 x T30	6	10,28
41597	5 x T40	6	10,28

\* en comparación con el Standard-Bit de Wiha

### Phillips (PH2), de 25 unid., 1/4" C6,3 en caja

n° pdo.			€/unid.
42294	25 x PH2	1	51,42
42295	25 x PZ2	1	51,42
42303	25 x T20	1	51,42
42304	25 x T25	1	51,42
42305	25 x T30	1	51,42

\* en comparación con el Standard-Bit de Wiha

## Clip para el cinturón



### para juego de bits BitBuddy® y FlipSelector

7945H

n° pdo.		€/unid.
36990	10	4,32



Juego de bits XLSelector Standard de 25 mm



en surtido de 18 unid. con carraca para bits, con forma C 6,3 (1/4")

7948043

n° pdo.		€/unid.
36951	5	63,99
+	1 x PH1 / 1 x PH2	
+	1 x PZ1 / 1 x PZ2 / 1 x PZ3	
+	1 x T10 / 1 x T15 / 1 x T20 / 1 x T25 / 1 x T30 / 1 x T40	
●	1 x 3.0 mm / 1 x 4.0 mm / 1 x 5.0 mm / 1 x 6.0 mm	
○	1 x Portabits magnético 58 mm de 1/4"	
	1 x Carraca para bits de 90 mm con rueda dentada de hexágono exterior, de 1/4"	
	1 x XLSelector	

Juego de bits XLSelector Standard de 25 mm



en surtido, de 32 unid. de 1/4" C6,3

7948005

n° pdo.		€/unid.
29417	5	55,19
⊖	1 x 4.5 mm / 1 x 5.5 mm / 1 x 6.5 mm	
+	2 x PH1 / 4 x PH2 / 1 x PH3	
+	2 x PZ1 / 5 x PZ2 / 1 x PZ3	
+	2 x T10 / 2 x T15 / 2 x T20 / 3 x T25 / 2 x T30 / 1 x T40	
○	1 x Portabits magnético 58 mm de 1/4"	
	1 x XLSelector	

en surtido, de 32 unid. de 1/4" C6,3

7948927

n° pdo.		€/unid.
29416	5	89,50
⊖	1 x 0 / 1 x 1 / 1 x 2 / 1 x 3 / 1 x 4	
⊖	1 x 4 / 1 x 6 / 1 x 8 / 1 x 10	
●	1 x TR2,0 / 1 x TR2,5 / 1 x TR3,0 / 1 x TR4,0 / 1 x TR5,0 / 1 x TR6,0	
+	1 x 6 / 1 x 8 / 1 x 10	
+	1 x T8H / 1 x T9H / 1 x T10H / 1 x T15H / 1 x T20H / 1 x T25H / 1 x T27H / 1 x T30H / 1 x T40H	
■	1 x #1 / 1 x #2 / 1 x #3	
●	1 x Soporte de cambio rápido CentroFix, magnético, forma E 6.3	
	1 x XLSelector	



**en surtido, de 14 unid. de 1/4" C6,3**

7947999

n° pdo.	🏠	€/unid.
39078	10	29,28
⊖	1 x 5.5 mm	
⊕	1 x PH2	
⊕	1 x PZ1 / 1 x PZ2 / 1 x PZ3	
⊕	1 x T15 / 1 x T20 / 1 x T25 / 1 x T30	
●	1 x 3.0 mm / 1 x 4.0 mm / 1 x 5.0 mm	
○	1 x Portabits magnético 58 mm de 1/4"	
	1 x FlipSelector	

**ranurados, Phillips, Pozidriv, de 14 unid., de 1/4" C6,3**

7947005

n° pdo.	🏠	€/unid.
39029	10	23,50
⊖	1 x 5.5 mm	
⊕	1 x PH1 / 3 x PH2 / 1 x PH3	
⊕	1 x PZ1 / 4 x PZ2 / 1 x PZ3	
○	1 x Portabits magnético 58 mm de 1/4"	
	1 x FlipSelector	

**Phillips, Pozidriv, TORX®, de 14 unid. de 1/4" C6,3**

7947904

n° pdo.	🏠	€/unid.
39040	10	26,40
⊕	2 x PH2	
⊕	1 x PZ1 / 2 x PZ2 / 1 x PZ3	
⊕	1 x T10 / 1 x T15 / 1 x T20 / 1 x T25 / 1 x T30 / 1 x T40	
○	1 x Portabits magnético 58 mm de 1/4"	
	1 x FlipSelector	

**Pozidriv, TORX®, de 14 unid. de 1/4" C6,3**

7947905

n° pdo.	🏠	€/unid.
39041	10	26,40
⊕	1 x PZ1 / 2 x PZ2 / 1 x PZ3	
⊕	1 x T10 / 1 x T15 / 2 x T20 / 2 x T25 / 1 x T30 / 1 x T40	
○	1 x Portabits magnético 58 mm de 1/4"	
	1 x FlipSelector	

**TORX®, de 14 unid. de 1/4" C6,3**

7947505

n° pdo.	🏠	€/unid.
39124	10	29,18
⊕	1 x T7 / 1 x T8 / 1 x T9 / 1 x T10 / 2 x T15 / 2 x T20 / 2 x T25 / 1 x T30 / 1 x T40	
○	1 x Portabits magnético 58 mm de 1/4"	
	1 x FlipSelector	

**TORX® Tamper Resistant (con taladro), de 14 unid., de 1/4" C6,3**

7947505TR

n° pdo.	🏠	€/unid.
39037	10	43,75
⊕	1 x T7H / 1 x T8H / 1 x T9H / 1 x T10H / 2 x T15H / 2 x T20H / 2 x T25H / 1 x T30H / 1 x T40H	
○	1 x Portabits magnético 58 mm de 1/4"	
	1 x FlipSelector	

**hexagonales, de 12 unid. de 1/4" C6,3**

7947902

n° pdo.	🏠	€/unid.
39039	10	38,84
●	1 x 1.5 mm / 1 x 2.0 mm / 1 x 2.5 mm / 2 x 3.0 mm / 2 x 4.0 mm / 1 x 5.0 mm / 1 x 6.0 mm / 1 x 8.0 mm	
○	1 x Portabits magnético 58 mm de 1/4"	
	1 x FlipSelector	

**SIT (para tornillos Assy® y Pias), de 14 unid., de 1/4" C6,3**

7947995

n° pdo.	🏠	€/unid.
39045	10	51,66
⊕	2 x SIT 10 / 4 x SIT 20 / 3 x SIT 25 / 2 x SIT 30 / 1 x SIT 40	
○	1 x Portabits magnético 58 mm de 1/4"	
	1 x FlipSelector	

Juego de bits FlipSelector Standard de 25 mm



en surtido, de 15 unid., de 1/4" C6,3, con clip para el cinturón, en blíster

SB7947999

n° pdo.	📦	€/unid.
39083	5	31,18
⊖	1 x 5.5 mm	
⊕	1 x PH2	
⊕	1 x PZ1 / 1 x PZ2 / 1 x PZ3	
⊕	1 x T15 / 1 x T20 / 1 x T25 / 1 x T30	
⊕	1 x 3.0 mm / 1 x 4.0 mm / 1 x 5.0 mm	
○	1 x Portabits magnético 58 mm de 1/4"	
	1 x Clip para el cinturón	
	1 x FlipSelector	

SIT (para tornillos Assy® y Pias), de 15 unid., de 1/4" C6,3, con clip para el cinturón, en blíster

SB7947005

n° pdo.	📦	€/unid.
39049	5	25,38
⊖	1 x 5.5 mm	
⊕	1 x PH1 / 3 x PH2 / 1 x PH3	
⊕	1 x PZ1 / 4 x PZ2 / 1 x PZ3	
○	1 x Portabits magnético 58 mm de 1/4"	
	1 x Clip para el cinturón	
	1 x FlipSelector	

Phillips, Pozidriv, TORX®, de 15 unid. de 1/4" C6,3, con clip para el cinturón, en blíster

SB7947904

n° pdo.	📦	€/unid.
39060	5	28,42
⊕	2 x PH2	
⊕	1 x PZ1 / 2 x PZ2 / 1 x PZ3	
⊕	1 x T10 / 1 x T15 / 1 x T20 / 1 x T25 / 1 x T30 / 1 x T40	
○	1 x Portabits magnético 58 mm de 1/4"	
	1 x Clip para el cinturón	
	1 x FlipSelector	

TORX®, de 15 unid., de 1/4" C6,3, con clip para el cinturón, en blíster

SB7947505

n° pdo.	📦	€/unid.
39056	5	31,05
⊕	1 x T7 / 1 x T8 / 1 x T9 / 1 x T10 / 2 x T15 / 2 x T20 / 2 x T25 / 1 x T30 / 1 x T40	
○	1 x Portabits magnético 58 mm de 1/4"	
	1 x Clip para el cinturón	
	1 x FlipSelector	

TORX® Tamper Resistant (con taladro), de 15 unid., de 1/4" C6,3, con clip para el cinturón, en blíster

SB7947505TR

n° pdo.	📦	€/unid.
39057	5	45,62
⊕	1 x T7H / 1 x T8H / 1 x T9H / 1 x T10H / 2 x T15H / 2 x T20H / 2 x T25H / 1 x T30H / 1 x T40H	
○	1 x Portabits magnético 58 mm de 1/4"	
	1 x Clip para el cinturón	
	1 x FlipSelector	

hexagonales, de 15 unid. de 1/4" C6,3, con clip para el cinturón, en blíster

SB7947902

n° pdo.	📦	€/unid.
39059	5	40,86
⊕	1 x 1.5 mm / 1 x 2.0 mm / 1 x 2.5 mm / 2 x 3.0 mm / 2 x 4.0 mm / 1 x 5.0 mm / 1 x 6.0 mm / 1 x 8.0 mm	
○	1 x Portabits magnético 58 mm de 1/4"	
	1 x Clip para el cinturón	
	1 x FlipSelector	

**Juego de bits Collector Standard de 25 mm**



**en surtido, de 33 unid. de 1/4" C6,3 incl. caja**

7928913

n° pdo.		€/unid.
34686	5	67,42

	1 x 4.5 mm / 1 x 5.5 mm / 1 x 6.5 mm
	2 x PH1 / 5 x PH2 / 2 x PH3
	2 x PZ1 / 5 x PZ2 / 2 x PZ3
	1 x T10 / 1 x T15 / 1 x T20 / 1 x T25 / 1 x T30 / 1 x T40
	1 x 4.0 mm / 1 x 5.0 mm / 1 x 6.0 mm
	1 x Portabits Porta-Puntas con bloqueo mecánico 1/4", magnético en caja
	1 x Destornillador con portabits SoftFinish® magnético de 1/4"
	1 x Collector Box

**Juego de bits Collector Security Standard de 25 mm**



**en surtido, de 28 unid. de 1/4", incl. caja**

7928928

n° pdo.		€/unid.
09393	5	97,67

	1 x T8H / 1 x T10H / 1 x T15H / 1 x T20H / 1 x T25H / 1 x T27H / 1 x T30H / 1 x T40H
	1 x 6 / 1 x 8 / 1 x 10
	1 x 1 / 1 x 2 / 1 x 3 / 1 x 4
	1 x 4 / 1 x 6 / 1 x 8 / 1 x 10
	1 x TR3/32 / 1 x TR5/64 / 1 x TR7/64 / 1 x TR1/8 / 1 x TR9/64 / 1 x TR5/32
	1 x Portabits magnético 58 mm de 1/4"
	1 x Destornillador con portabits SoftFinish® magnético de 1/4"
	1 x Collector Box

**Juego de bits Collector Standard de 25 mm**



**en surtido, de 62 unid. de 1/4" C6,3, incl. caja**







7928923





n° pdo.		€/unid.
07943	5	88,04





	1 x 4.5 mm / 1 x 5.5 mm / 1 x 6.5 mm
	7 x PH1 / 13 x PH2 / 3 x PH3
	7 x PZ1 / 13 x PZ2 / 3 x PZ3
	1 x T10 / 1 x T15 / 1 x T20 / 1 x T25 / 1 x T30 / 1 x T40
	1 x 3.0 mm / 1 x 4.0 mm / 1 x 5.0 mm / 1 x 6.0 mm
	1 x Portabits Porta-Puntas con bloqueo mecánico 1/4", magnético en caja
	1 x Collector Box

## Juego de bits Standard de 25 mm



en surtido, de 32 unid., de 1/4" C6,3 incl. caja		797901
n° pdo.		€/unid.
26252	1	42,73
	1 x 4.5 mm / 1 x 5.5 mm / 1 x 6.5 mm	
	2 x PH1 / 6 x PH2 / 1 x PH3	
	2 x PZ1 / 6 x PZ2 / 1 x PZ3	
	1 x T10 / 1 x T15 / 1 x T20 / 1 x T25 / 1 x T30 / 1 x T40	
	1 x 4.0 mm / 1 x 5.0 mm / 1 x 6.0 mm	
	1 x Portabits magnético 60 mm 1/4" imán extra fuerte de en caja	
	1 x Bitbox	

Pozidriv, TORX®, de 32 unid. de 1/4" C6,3, incl. caja		797902
n° pdo.		€/unid.
26253	1	38,47
	5 x PZ1 / 10 x PZ2 / 3 x PZ3	
	2 x T10 / 2 x T15 / 2 x T20 / 2 x T25 / 2 x T30 / 2 x T40	
	1 x Portabits magnético 60 mm 1/4" imán extra fuerte de en caja	
	1 x Bitbox	

TORX®, Pozidriv, de 32 unid. de 1/4" C6,3 incl. caja		797903
n° pdo.		€/unid.
36310	1	39,73
	2 x PZ1 / 3 x PZ2 / 1 x PZ3	
	2 x T10 / 6 x T15 / 6 x T20 / 6 x T25 / 2 x T30 / 2 x T40	
	1 x Portabits magnético 60 mm 1/4" imán extra fuerte de en caja	
	1 x Bitbox	

## CUADRO INFORMATIVO: con cabeza esférica hexagonal

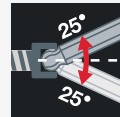

### Cabeza esférica hexagonal de Wiha

- La punta de bola se puede girar un máximo de 25° a izquierda y derecha.

## CUADRO INFORMATIVO: Juego Perfil de seguridad Tamper Resistant TORX®



- El perfil de seguridad se utiliza para dificultar el acceso al dispositivo, p. ej. interfonos, radiadores eléctricos de acumulación nocturna y termostatos.
- Con el perfil Tamper Resistant TORX® se pueden atornillar tanto tornillos Torx® H como tornillos Torx® normales.

## CUADRO INFORMATIVO: MagicRing®



### MagicRing® de Wiha

- El anillo elástico de acero sujeta los tornillos de cabeza hexagonal de forma segura
- Una innovación que convencerá a cualquier usuario.

**Bit Standard de 25 mm**

**ranurado de 1/4" C6,3**

7010Z

n° pdo.		mm			€/unid.
01623	4,5	25	0,6	10	1,31
01624	5,5	25	0,8	10	1,31
01626	6,5	25	1,2	10	1,31
01627	8,0	25	1,6	10	1,31

**Phillips 1/4" C6,3**

7011Z

n° pdo.		mm		€/unid.
05298	PH0	25	10	1,03
01657	PH1	25	10	0,73
01658	PH2	25	10	0,73
01659	PH3	25	10	0,73
01649	PH4	32	10	3,97

**Pozidriv 1/4" C6,3**

7012Z

n° pdo.		mm		€/unid.
05300	PZ0	25	10	1,03
01688	PZ1	25	10	0,73
01689	PZ2	25	10	0,73
01690	PZ3	25	10	0,73
01681	PZ4	32	10	3,97

**TORX® 1/4" C6,3**

7015Z

n° pdo.		mm		€/unid.
26250	T3	25	10	1,89
25097	T4	25	10	1,89
01711	T5	25	10	1,18
01712	T6	25	10	1,18
01713	T7	25	10	1,18
01714	T8	25	10	1,18
01715	T9	25	10	1,18
01716	T10	25	10	1,13
01717	T15	25	10	1,13
01718	T20	25	10	1,13
01719	T25	25	10	1,13
01720	T27	25	10	1,13
01721	T30	25	10	1,13
01722	T40	25	10	1,13
01723	T45	35	10	3,97
01724	T50	35	10	3,97

**TORX® cónico de 1/4" C6,3**

7015ZK

n° pdo.		mm		€/unid.
04925	T10	25	10	2,95
04926	T15	25	10	2,95
04927	T20	25	10	2,95
04928	T25	25	10	2,95
04929	T27	25	10	2,95
04930	T30	25	10	2,95
04931	T40	25	10	2,95

**TORX PLUS® 1/4" C6,3**

7016Z

n° pdo.		mm		€/unid.
25994	3IP	25	10	3,59
25996	4IP	25	10	3,59
25998	5IP	25	10	3,32
23173	6IP	25	10	3,32
23175	7IP	25	10	3,32
23177	8IP	25	10	3,32
23179	9IP	25	10	3,32
23181	10IP	25	10	3,32
23183	15IP	25	10	3,32
23185	20IP	25	10	3,32
23187	25IP	25	10	3,32
23189	27IP	25	10	3,32
23191	30IP	25	10	3,32
23193	40IP	25	10	3,32

**TORX® Tamper Resistant (con taladro), de 1/4" C6,3**

7015ZH

n° pdo.		mm		€/unid.
03115	T7H	25	10	3,01
03117	T8H	25	10	3,01
01726	T9H	25	10	3,01
01727	T10H	25	10	3,01
01728	T15H	25	10	3,01
01729	T20H	25	10	3,01
01730	T25H	25	10	3,01
01731	T27H	25	10	3,01
01732	T30H	25	10	3,01
01733	T40H	25	10	3,01



**TORX PLUS® Security de 1/4" C6,3 (con agujero)**

7016ZIPR

n° pdo.		mm		€/unid.
27530	8IPR	25	10	8,18
26346	10IPR	25	10	8,18
26347	15IPR	25	10	8,18
26348	20IPR	25	10	8,18
26349	25IPR	25	10	8,18
26350	30IPR	25	10	8,18
26351	40IPR	35	10	8,18



**con cabeza esférica hexagonal MagicRing®, de 1/4" C6,3**

7017ZR

n° pdo.		mm		€/unid.
22959	3.0	38	10	7,66
22960	4.0	38	10	7,66
22961	5.0	38	10	7,66
22962	6.0	38	10	7,66



**con cabeza esférica hexagonal de 1/4" C6,3**

7017ZR

n° pdo.		mm		€/unid.
01734	1.5	38	10	5,46
01735	2.0	38	10	5,46
01736	2.5	38	10	5,46
01737	3.0	38	10	5,46
01738	4.0	38	10	5,46
01739	5.0	38	10	5,46
01740	6.0	38	10	5,46



**hexagonal, MagicRing® de 1/4" C6,3**

7013RZ

n° pdo.		mm		€/unid.
22955	3.0	25	10	4,25
22956	4.0	25	10	4,25
22957	5.0	25	10	4,25
22958	6.0	25	10	4,25

**hexagonal de 1/4" C6,3**

7013Z

n° pdo.		mm		€/unid.
04011	1.5	25	10	2,73
01703	2.0	25	10	2,73
01704	2.5	25	10	2,73
01705	3.0	25	10	2,73
01706	4.0	25	10	2,73
01707	5.0	25	10	2,73
39875	5.5	25	10	2,73
01708	6.0	25	10	2,73
01709	8.0	25	10	3,38
01710	10.0	25	10	3,56



**hexagonal con taladro 1/4" C6,3**

7013ZH

n° pdo.		mm		€/unid.
25560	TR2,0	25	10	5,21
25561	TR2,5	25	10	5,21
25562	TR3,0	25	10	5,21
25563	TR4,0	25	10	5,21
25564	TR5,0	25	10	5,21
26309	TR6,0	25	10	5,21
20558	TR5/64	25	10	5,21
20556	TR3/32	25	10	5,21
20559	TR7/64	25	10	5,21
20555	TR1/8	25	10	5,21
20560	TR9/64	25	10	5,21
20557	TR5/32	25	10	5,21
30050	TR3/16	25	10	5,21



**con hembra cuadrada de 1/4" C6,3**

7018Z

n° pdo.			mm		€/unid.
06634	#1	2,3	25	5	2,69
06635	#2	2,8	25	5	2,69
06636	#3	3,3	25	5	2,69



**tensor de 1/4" C6,3**

7019ZSP

n° pdo.		mm		€/unid.
27064	4	25	10	3,71
27065	6	25	10	3,71
27066	8	25	10	3,71
27067	10	25	10	3,71

**estriado 1/4" C6,3**

7019ZXZ

n° pdo.		mm		€/unid.
26352	M3	25	10	3,71
26353	M4	25	10	3,71
26354	M5	25	10	3,71
26355	M6	25	10	3,71
26356	M8	35	10	3,97



**SIT (para tornillos Assy® y Pias) de 1/4" C6,3**

7019ZSIT

n° pdo.		mm			€/unid.
27256	SIT 10	25	rosado	10	3,71
27257	SIT 20	25	naranja	10	3,71
27258	SIT 25	25	verde	10	3,71
27259	SIT 30	25	amarilla	10	3,71
27260	SIT 40	25	rosado	10	3,71



**Torq-Set® 1/4" C6,3**

7019ZOTTS

n° pdo.		mm		€/unid.
26249	2	25	10	6,50
26045	3	25	10	6,50
22591	4	25	10	6,50
22592	5	25	10	6,50
22593	6	25	10	6,50
22594	8	25	10	6,50
22595	10	25	10	6,50
25572	1/4	32	10	6,50

**Tri-Wing®, 1/4" C6,3**

7019ZOTTW

n° pdo.		mm		€/unid.
22603	0	25	10	6,50
22604	1	25	10	6,50
22605	2	25	10	6,50
22606	3	25	10	6,50
22607	4	25	10	6,50
22608	5	25	10	6,50

### Bit DryWall Stop Standard 25 mm



#### Phillips, 1/4"

7011Z

n° pdo.		mm		€/unid.
39382	PH2	25	10	3,01

### Juego de bits Standard de 25 mm



#### 10-tlg. 1/4" C6,3 in Box

n° pdo.			€/unid.
32055	10 x PH1	10	6,22
07855	3 x PH1	10	3,53
36275	20 x PH2	10	11,69
24733	10 x PH2	10	6,22
07856	3 x PH2	10	3,53
36280	10 x PH3	10	6,22
07857	3 x PH3	10	3,53
35709	20 x PZ1	10	11,69
32070	10 x PZ1	10	6,22
07859	3 x PZ1	10	3,53
36282	20 x PZ2	10	11,69
24742	10 x PZ2	10	6,22
07860	3 x PZ2	10	3,53
32071	10 x PZ3	10	6,22
07861	3 x PZ3	10	3,53
35832	10 x T10	10	9,56
08421	2 x T10	10	3,83
34746	10 x T15	10	9,56
08422	2 x T15	10	3,83
24746	10 x T20	10	9,56

08423	2 x T20	10	3,83
08424	2 x T25	10	3,83
24748	10 x T25	10	9,56
08425	2 x T30	10	3,83
24750	10 x T30	10	9,56
08426	2 x T40	10	3,83
36288	10 x T40	10	9,56
38649	2 x T10H	10	7,29
38650	2 x T15H	10	7,29
38651	2 x T20H	10	7,29
38652	2 x T25H	10	7,29
38653	2 x T30H	10	7,29
38654	2 x T40H	10	7,29
22655	1 x 4,0 x 5,0 x 6,0	10	17,59
38656	2 x 3,0	10	6,72
25681	2 x 4,0	10	6,63
25679	2 x 5,0	10	6,63
38657	2 x 6,0	10	6,51
38658	2 x #1	10	6,71
38659	2 x #2	10	6,71
38660	2 x #3	10	6,71



**Juego de bits de diámetro reducido de 25 mm**



**de 10 unid., de 1/4" C6,3 en caja**

n° pdo.			€/unid.
35834	10 x PH2	10	12,20
36285	10 x PZ2	10	12,20

**Bit Set DryWall Stop 25 mm**



**Phillips, de 2 unid., de 1/4" C6,3 en caja**

XX7011--922---

n° pdo.			€/unid.
27077	PH2	10	5,86

**Juego de bits Standard de 25 mm**



**e 50 unid., de 1/4" C6,3 en envase grande**

n° pdo.			€/unid.
08047	1 x PH1	1	27,92
08048	1 x PH2	1	27,92
08049	1 x PH3	1	27,92
08056	1 x PZ1	1	27,92
08057	1 x PZ2	1	27,92
08058	1 x PZ3	1	27,92
08065	1 x T10	1	41,23
08066	1 x T15	1	41,23
08067	1 x T20	1	41,23
08068	1 x T25	1	41,23
29544	1 x T27	1	41,23
08069	1 x T30	1	41,23
08070	1 x T40	1	41,23

**Bit Standard de 25 mm**





**de 100 unid., de 1/4" C6,3 en envase grande**

n° pdo.			€/unid.
40461	1 x PH2	1	50,84
40462	1 x PZ2	1	50,84
40463	1 x T20	1	70,98
40464	1 x T25	1	70,98
40465	1 x T30	1	70,98

**Bit Professional**



**ranurado de 1/4" E6,3**

7040ZL

n° pdo.		mm			€/unid.
33961	2.5	70	0.4	5	5,29
01790	3.0	50	0.5	5	4,20
33962	3.0	70	0.5	5	5,29
01792	3.5	50	0.6	5	4,20
33963	3.5	70	0.6	5	5,29
01791	4.0	50	0.5	5	4,20
01794	4.0	50	0.8	5	4,20
33964	4.0	70	0.8	5	5,29
01793	4.5	50	0.6	5	4,20
01795	5.5	50	0.8	5	4,20
01796	5.5	50	1.0	5	4,20
33965	5.5	70	1.0	5	5,29
01798	6.5	50	1.2	5	4,20
33966	6.5	70	1.2	5	5,29
01799	8.0	50	1.2	5	4,97
01800	8.0	50	1.6	5	4,97



**Phillips 1/4" E6,3**

7041Z

n° pdo.		mm		€/unid.
31960	PH00	50	5	3,97
31961	PH00	70	5	5,75
31962	PH00	90	5	6,87
32105	PH0	50	5	3,15
35456	PH0	70	5	4,98
35457	PH0	90	5	5,92
33703	PH1	50	5	2,95
01803	PH1	70	5	4,92
04126	PH1	90	5	5,75
23213	PH1	110	5	6,76
23219	PH1	127	5	7,46
22509	PH1	150	5	8,65
33704	PH2	50	5	2,95
01805	PH2	70	5	4,92
04009	PH2	90	5	5,75
05800	PH2	110	5	6,76
06888	PH2	127	5	7,46
22510	PH2	150	5	8,65
33705	PH3	50	5	2,95
04010	PH3	70	5	4,92
04127	PH3	90	5	5,75
23215	PH3	110	5	6,76
23217	PH3	127	5	7,46
22511	PH3	150	5	8,65



**Pozidriv 1/4" E6,3**

7042Z

n° pdo.		mm		€/unid.
31957	PZ0	50	5	3,15
31958	PZ0	70	5	4,98
31959	PZ0	90	5	5,92
33706	PZ1	50	5	2,95
01808	PZ1	70	5	4,92
01809	PZ1	90	5	5,75
23221	PZ1	110	5	6,76
23225	PZ1	127	5	7,46
23227	PZ1	150	5	8,65
33707	PZ2	50	5	2,95
01811	PZ2	70	5	4,92
01812	PZ2	90	5	5,75
05799	PZ2	110	5	6,76
06889	PZ2	127	5	7,46
23228	PZ2	150	5	8,65
33708	PZ3	50	5	2,95
04059	PZ3	70	5	4,92
04176	PZ3	90	5	5,75
23223	PZ3	110	5	6,76
23226	PZ3	127	5	7,46
22512	PZ3	150	5	8,65



**PlusMinus/Phillips de 1/4" E6,3**

7049PHM

n° pdo.		mm		€/unid.
32490	SL/PH1	50	5	5,34
32491	SL/PH1	70	5	6,92
32686	SL/PH1	90	5	8,18
32492	SL/PH2	50	5	5,34
32493	SL/PH2	70	5	6,92
32687	SL/PH2	90	5	8,18



**PlusMinus/Pozidriv 1/4" E6,3**

7049PZM

n° pdo.		mm		€/unid.
32494	SL/PZ1	50	5	5,34
32495	SL/PZ1	70	5	6,92
32688	SL/PZ1	90	5	8,18
32496	SL/PZ2	50	5	5,34
32497	SL/PZ2	70	5	6,92
32689	SL/PZ2	90	5	8,18



**TORX® 1/4" E6,3**

7045Z

n° pdo.		mm		€/unid.
39184	T1	50	5	5,54
39185	T2	50	5	5,54
39186	T3	50	5	4,85
39187	T4	50	5	4,85
32299	T5	50	5	4,20
32302	T6	50	5	4,20
33709	T6	70	5	6,04
33717	T6	90	5	7,46
38370	T6	150	5	10,43
32303	T7	50	5	4,20
33710	T7	70	5	6,04
33718	T7	90	5	7,46
38371	T7	150	5	10,44
32304	T8	50	5	4,20
33711	T8	70	5	6,04
33719	T8	90	5	7,46
36327	T8	150	5	10,44
32305	T9	50	5	4,20
33712	T9	70	5	6,04
33720	T9	90	5	7,46
38372	T9	150	5	10,44
32306	T10	50	5	4,20
33713	T10	70	5	6,04
33721	T10	90	5	7,46
33725	T10	110	5	9,12
33726	T10	150	5	10,44
32307	T15	50	5	4,20
33714	T15	70	5	6,04
33722	T15	90	5	7,46
33727	T15	110	5	9,13
33728	T15	150	5	10,43
32308	T20	50	5	4,20
33715	T20	70	5	6,04
33723	T20	90	5	7,46
33729	T20	110	5	9,13
33730	T20	150	5	10,43
32309	T25	50	5	4,20
33716	T25	70	5	6,04
33724	T25	90	5	7,46
33731	T25	110	5	9,13
33732	T25	150	5	10,43
33920	T27	50	5	4,20
33921	T27	70	5	6,04
33922	T27	90	5	7,46
33923	T30	50	5	4,20
33924	T30	70	5	6,04
33925	T30	90	5	7,46
33926	T30	110	5	9,12
33927	T30	150	5	10,44
33928	T40	50	5	4,20
33929	T40	70	5	6,04
33930	T40	90	5	7,46
33931	T40	110	5	9,12
33932	T40	150	5	10,73



**TORX® con cabeza esférica de 1/4" E6,3**

7045Z

n° pdo.		mm		€/unid.
32410	T10	50	5	5,32
32416	T10	70	5	7,03
32417	T15	50	5	5,32
32418	T15	70	5	7,03
32411	T20	50	5	5,32
32419	T20	70	5	7,03
32412	T25	50	5	5,32
32421	T25	70	5	7,03
32413	T27	50	5	5,32
32414	T30	50	5	5,32
32423	T30	70	5	7,03
32415	T40	50	5	5,32



**TORX® MagicSpring® 1/4" E6,3**

7045R

n° pdo.		mm		€/unid.
34452	T10	50	5	6,41
34453	T15	50	5	6,41
34454	T20	50	5	6,41
34455	T25	50	5	6,41
34456	T30	50	5	6,41
34457	T40	50	5	6,41



**TORX® Tamper Resistant (con taladro), de 1/4" E6,3**

7045ZH

n° pdo.		mm		€/unid.
21045	T7H	50	5	5,78
21047	T8H	50	5	5,78
20218	T9H	50	5	5,78
20219	T10H	50	5	5,78
39188	T10H	90	5	8,92
24867	T15H	50	5	5,78
39189	T15H	90	5	8,92
20220	T20H	50	5	5,78
39190	T20H	90	5	8,92
20221	T25H	50	5	5,78
39191	T25H	90	5	8,92
20222	T27H	50	5	5,78
39192	T27H	90	5	8,92
20223	T30H	50	5	5,78
39193	T30H	90	5	8,92
20224	T40H	50	5	5,78
39194	T40H	90	5	8,92



**TORX PLUS® 1/4" E6,3**

7046Z

n° pdo.		mm		€/unid.
28481	5IP	50	5	6,41
26000	6IP	50	5	6,41
26002	7IP	50	5	6,41
23195	8IP	50	5	6,41
23197	9IP	50	5	6,41
23199	10IP	50	5	6,41
23201	15IP	50	5	6,41
23203	20IP	50	5	6,41
23205	25IP	50	5	6,41
23207	27IP	50	5	6,41
23209	30IP	50	5	6,41
23211	40IP	50	5	6,41



**Torq-Set® 1/4" E6,3**

7049ZOTTS

n° pdo.		mm		€/unid.
22596	4	50	5	8,65
22597	5	50	5	8,65
22598	6	50	5	8,65
22599	8	50	5	8,65
22600	10	50	5	8,65



**con cabeza esférica hexagonal de MagicRing® 1/4" E6,3**

7047ZR

n° pdo.		mm		€/unid.
25739	3.0	50	5	8,18
25740	4.0	50	5	8,18
25741	5.0	50	5	8,18
25742	6.0	50	5	8,18



**hexagonal, MagicRing® de 1/4" E6,3**

7043ZR

n° pdo.		mm		€/unid.
23145	3.0	50	5	6,92
23147	4.0	50	5	6,92
23149	5.0	50	5	6,92
23151	6.0	50	5	6,92



**hexagonal de 1/4" E6,3**

7043Z

n° pdo.		mm		€/unid.
05301	1.5	50	5	4,39
05302	2.0	50	5	4,39
34554	2.0	70	5	5,62
39178	2.0	90	5	8,06
05303	2.5	50	5	4,39
34555	2.5	70	5	5,62
39179	2.5	90	5	8,06
04194	3.0	50	5	3,98
34556	3.0	70	5	5,62
39180	3.0	90	5	8,06
04195	4.0	50	5	3,98
34557	4.0	70	5	5,62
39181	4.0	90	5	8,06
04196	5.0	50	5	3,98
34558	5.0	70	5	5,62
39182	5.0	90	5	8,06
04197	6.0	50	5	3,98
34559	6.0	70	5	5,62
39183	6.0	90	5	8,06
04198	8.0	50	5	6,87
34560	8.0	70	5	8,41

**con hembra cuadrada de 1/4" E6,3**













7048Z

n° pdo.			mm		€/unid.
06637	#1	2.3	50	5	4,92
39206	#1	2.3	90	5	8,06
06638	#2	2.8	50	5	4,92
39207	#2	2.8	90	5	8,06
06639	#3	3.3	50	5	4,92
39208	#3	3.3	90	5	8,06















## Bit Set Professional



### de 2 unid., 50 mm de 1/4" E6,3 en caja

n° pdo.			€/unid.
38676	 2 x PH1	10	7,29
36193	 2 x PH2	10	7,29
38677	 2 x PH3	10	7,29
38679	 2 x PZ1	10	7,29
38680	 2 x PZ2	10	7,29
38681	 2 x PZ3	10	7,29
38684	 2 x T10	10	9,79
38685	 2 x T15	10	9,79
38686	 2 x T20	10	9,79
38687	 2 x T25	10	9,79
38689	 2 x T30	10	9,79
38690	 2 x T40	10	9,79

### de 2 unid., 70 mm de 1/4" E6,3 en caja

n° pdo.			€/unid.
38706	 2 x PH1	10	11,44
38707	 2 x PH2	10	11,44
38708	 2 x PH3	10	11,44
38709	 2 x PZ1	10	11,44
38710	 2 x PZ2	10	11,44
38711	 2 x PZ3	10	11,44
36086	 2 x SL/PZ1	10	12,95
36082	 2 x SL/PZ2	10	12,95
38712	 2 x T10	10	13,71
38713	 2 x T15	10	13,71
38714	 2 x T20	10	13,71
38715	 2 x T25	10	13,71
38717	 2 x T30	10	13,71



**TORX® cabeza esférica 1/4" incl. barra de bits 11 unid.**

7045BE9570

n° pdo.	📦	€/unid.
32804	1	64,11
2 x T10 / 2 x T15 / 2 x T20 / 2 x T25 / 2 x T30 1 x Barra de bits		



**en surtido, de 66 unid., incl. caja**

7000SK65ESD

n° pdo.	📦	€/unid.
39971	1	170,74
1 x 0.8 mm / 1 x 1.2 mm / 1 x 1.5 mm / 1 x 1.8 mm / 1 x 2.0 mm / 1 x 2.5 mm / 1 x 3.0 mm / 1 x 3.5 mm / 1 x 4.0 mm		
1 x 0.7 mm / 1 x 0.9 mm / 2 x 1.3 mm 0,05 / 1 x 1.5 mm / 1 x 2.0 mm / 1 x 2.5 mm / 1 x 3.0 mm / 2 x 4.0 mm / 5/32" / 1 x 1/16" / 1 x 5/64" / 1 x 3/32" / 1 x 7/64" / 1 x 1/8" / 1 x 9/64"		
1 x T3 / 1 x T4 / 1 x T5 / 1 x T6 / 1 x T7 / 1 x T8 / 1 x T9 / 1 x T10 / 1 x T15 / 1 x T20		
1 x PL1 / 1 x PL2 / 1 x PL3 / 1 x PL4 / 1 x PL5 / 1 x PL6		
1 x PH000 / 1 x PH00 / 1 x PH0 / 1 x PH1		
1 x 5/64" / 1 x 3/32" / 1 x 7/64" / 1 x 1/8" / 1 x 9/64" / 1 x 5/32" / 1 x 3/16" / 1 x 7/32" / 1 x 2.0 mm / 1 x 2.5 mm / 1 x 3.0 mm / 1 x 3.5 mm / 1 x 4.0 mm / 1 x 4.5 mm / 1 x 5.0 mm / 1 x 5.5 mm		
1 x Adaptador de 1/4" para micro bits con forma de 4 mm		
1 x Carraca para bits de 90 mm con rueda dentada de hexágono exterior, de 1/4"		
1 x Destornillador con mango ESD para micro bits con forma de 4 mm		
1 x Prolongación de 100 mm para micro bits forma de 4 mm y Destornillador de precisión ESD		
1 x Metallbox		

**CUADRO INFORMATIVO: TORX® con cabeza esférica**

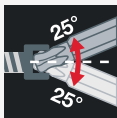

**Cabeza esférica TORX® de Wiha**

- Con geometría optimizada de la cabeza esférica TORX®
- Resistencia aumentada gracias al moldeado especial en frío realizado en instalaciones desarrolladas por Wiha especialmente para este fin.
- Permite atornillar en ángulos de hasta 25°.
- Mayor facilidad para insertar las herramientas y para atornillar, especialmente en lugares de difícil acceso.
- Programa amplio de productos: llaves, bits y destornilladores SoftFinish®.

**CUADRO INFORMATIVO: Pentalobe**



**El perfil de seguridad para dispositivos Apple**

- Ideal para trabajos de reparación en smartphones, tablet-PCs y ordenadores portátiles Apple.
- Atención: Es imprescindible tener en cuenta las condiciones de garantía del fabricante del dispositivo.

**Micro bit de 28 mm**



**ranurado con forma de C4 4 mm**

7000Z

n° pdo.		mm			€/unid.
40600	0.8	28	0.2	10	2,31
40601	1.2	28	0.3	10	2,31
40602	1.5	28	0.3	10	2,31
40603	1.8	28	0.3	10	2,31
40604	2.0	28	0.4	10	2,31
40605	2.5	28	0.4	10	2,31
40606	3.0	28	0.5	10	2,31
40607	3.5	28	0.6	10	2,31
40608	4.0	28	0.8	10	2,31

**Phillips con forma de C4 4 mm**

7001

n° pdo.		mm		€/unid.
40609	PH000	28	10	2,31
40610	PH00	28	10	2,31
40611	PH0	28	10	2,31
40612	PH1	28	10	2,31
40613	PH2	28	10	2,31

**hexagonal con forma de C4 4 mm**

7003Z

n° pdo.		mm		€/unid.
40614	0.7	28	10	2,31
40615	0.9	28	10	2,31
40616	1.3	28	10	2,31
40617	1.5	28	10	2,31
40618	2.0	28	10	2,31
40619	2.5	28	10	2,31
40620	3.0	28	10	2,31
40621	4.0	28	10	2,31

**hexagonal con forma de C4 4 mm**

7003Z

n° pdo.		mm		€/unid.
40622	1/16"	28	10	2,31
40623	5/64"	28	10	2,31
40624	3/32"	28	10	2,31
40625	7/64"	28	10	2,31
40626	1/8"	28	10	2,31
40627	9/64"	28	10	2,31

**TORX® con forma de C4 4 mm**

7005

n° pdo.		mm		€/unid.
40628	T1	28	10	4,62
40629	T2	28	10	4,62
40630	T3	28	10	2,31
40631	T4	28	10	2,31
40632	T5	28	10	2,31
40633	T6	28	10	2,31
40634	T7	28	10	2,31
40635	T8	28	10	2,31
40636	T9	28	10	2,31
40637	T10	28	10	2,31
40638	T15	28	10	2,31
40639	T20	28	10	2,31

**Pentalobe con forma de C4 4 mm**

7009

n° pdo.		mm		€/unid.
40640	PL1	28	10	4,62
40641	PL2	28	10	4,62
40642	PL3	28	10	4,62
40643	PL4	28	10	4,62
40644	PL5	28	10	4,62
40645	PL6	28	10	4,62



### Micro llave de vaso de 30 mm



#### de hexágono exterior con forma de C4 4 mm 7044Z

n° pdo.			mm		€/unid.
40654	2.0	30	10	4,62	
40655	2.5	30	10	4,62	
40656	3.0	30	10	4,62	
40657	3.5	30	10	4,62	
40658	4.0	30	10	4,62	
40659	4.5	30	10	4,62	
40660	5.0	30	10	4,62	
40661	5.5	30	10	4,62	

#### de hexágono exterior con forma de C4 4 mm 7044Z

n° pdo.			mm		€/unid.
40646	5/64"	30	10	4,62	
40647	3/32"	30	10	4,62	
40648	7/64"	30	10	4,62	
40649	1/8"	30	10	4,62	
40650	9/64"	30	10	4,62	
40651	5/32"	30	10	4,62	
40652	3/16"	30	10	4,62	
40653	7/32"	30	10	4,62	

### Prolongación de 100 mm



#### para micro bits forma de 4 mm y Destornillador de precisión ESD 7103

n° pdo.			mm		€/unid.
40663	4.0	4.0	100	10	10,55

### Adaptador de 1/4"



#### para micro bits con forma de 4 mm 7103

n° pdo.			mm		€/unid.
39964	4.0 mm	1/4"	25	10	9,35

### Portabits magnético



#### para micro bits con forma de 4 mm 7110

n° pdo.			mm		€/unid.
32505	4.0	1/4"	60	10	18,61

### Bit con rosca



#### Phillips M4 7311Z

n° pdo.			mm				€/unid.
01937	PH1	33	5.5	M4	8	10	9,18
01938	PH2	33	6	M4	8	10	9,18

#### Pozidriv M4 7312Z

n° pdo.			mm				€/unid.
01939	PZ1	33	5.5	M4	8	10	9,18
01940	PZ2	33	6	M4	8	10	9,18

#### Phillips M5 7321Z

n° pdo.			mm				€/unid.
01942	PH2	33	7	M5	8	10	9,44
01943	PH2	45	6	M5	8	10	9,44

#### Pozidriv M5 7322Z

n° pdo.			mm				€/unid.
01945	PZ2	33	7	M5	8	10	9,44
01946	PZ2	45	6	M5	8	10	9,44

#### TORX® M5 7325Z

n° pdo.			mm				€/unid.
35400	T10	45	6	M5	8	10	9,93
35401	T15	45	6	M5	8	10	9,93
35402	T20	45	6	M5	8	10	9,93
35403	T25	45	6	M5	8	10	9,93







#### Phillips M6 7331Z

n° pdo.			mm				€/unid.
04678	PH2	33	8	M6	8	10	9,93
04677	PH2	45	8	M6	8	10	9,93



### Pozidriv M6

7332Z

n° pdo.							€/unid.
04671	PZ2	33	8	M6	8	10	9,93
04670	PZ2	45	8	M6	8	10	9,93

### Phillips UNF 10/32"

7341Z

n° pdo.							€/unid.
01947	PH2	45	6	10/32 UNF	8	10	9,93

### Juego de bits de macho de roscar, combinado



### 1/4" 6 unid., incl. caja

79187B5

n° pdo.		€/unid.
28026	1	84,86





	1 x M3 x 36 mm / 1 x M4 x 39 mm / 1 x M5 x 41 mm / 1 x M6 x 44 mm / 1 x M8 x 51 mm
	1 x Caja

### Bit de macho de roscar combinado



### 1/4"

7807

n° pdo.					€/unid.
27897	M3	36	1/4	10	17,80
27898	M4	39	1/4	10	17,80
27899	M5	41	1/4	10	17,80
27900	M6	44	1/4	10	18,05
27901	M8	51	1/4	10	23,21
27963	M10	65	1/4	10	28,07

### Kegelsenker-Bit Set



### 6-tlg. 1/4" inkl. Box

79186B5

Best.-Nr.		€/unid.
28027	1	87,00

	M3 x 35 mm / M4 x 35 mm / M5 x 35 mm / M6 x 35 mm / M8 x 35 mm
---	--

Box

### Kegelsenker-Bit



### 1/4"

7806

Best.-Nr.							€/unid.
27892	6,3	35	1/4	M3	1,5	10	18,08
27893	8,3	35	1/4	M4	2	10	18,34
27894	10,4	35	1/4	M5	2,5	10	20,27
27895	12,4	35	1/4	M6	2,8	10	22,71
27896	16,5	35	1/4	M8	3,2	10	24,14
28058	20,5	35	1/4	M10	3,5	10	27,36

Vaso de encastre 55 mm



de hexágono exterior de 1/4" E6,3

7044Z

n° pdo.		mm		€/unid.
04514	5.0	55	5	6,87
04513	5.5	55	5	6,87
04512	6.0	55	5	6,87
04511	7.0	55	5	6,87
04510	8.0	55	5	6,87
04509	10.0	55	5	7,23
04508	13.0	55	5	9,01

Vástago de herramienta con bola



Cuadrado interior, hexagonal interior de 1/4" C6,3

7210

n° pdo.			mm		€/unid.
01933	1/4"	1/4"	25	5	10,56
04204	3/8"	1/4"	30	5	12,07

Inserto de llave de vaso, magnético de 55 mm



de hexágono exterior de 1/4" E6,3

7044M

n° pdo.		mm		€/unid.
04637	5.0	55	5	8,92
04636	5.5	55	5	8,92
04635	6.0	55	5	8,92
04634	7.0	55	5	8,92
04633	8.0	55	5	8,92
04632	10.0	55	5	9,44
04631	13.0	55	5	11,05

de hexágono exterior de 1/4" E6,3

7044M

n° pdo.		mm		€/unid.
04638	1/4"	55	5	9,18
04639	5/16"	55	5	9,18
04640	3/8"	55	5	9,68

Vástago de herramienta



Cuadrado interior, hexagonal interior de 1/4" E6,3

7240

n° pdo.			mm		€/unid.
01935	1/4"	1/4"	50	5	11,57
04362	3/8"	1/4"	50	5	13,82
04685	1/4"	1/4"	100	5	12,95
04684	3/8"	1/4"	100	5	15,08

Adaptador según norma DIN 7428.

**Pieza de unión con anillo de retención**



de hexágono exterior, cabezas cuadradas forma G 6,3 + G 10 + G 12,5

7201

n° pdo.					€/unid.
01924	1/4	1/4	25	2	13,20
01926	1/4	3/8	30	2	19,86
01922	1/4	1/2	35	2	22,63
01927	5/16	3/8	30	2	19,61
01923	5/16	1/2	35	2	23,12

**Pieza de unión con soporte de cambio rápido**



de hexágono exterior, cabezas cuadradas forma G 12,5

7201

n° pdo.					€/unid.
01930	1/2	1/4		2	38,35

**Destornillador de impacto manual juego**



en surtido, de 7 unid., de 1/2" incl. caja

24636B5

n° pdo.		€/unid.
32573	1	103,72

- 1 x Destornillador de impacto manual hembra cuadrada 1/2"
- 1 x Bit para destornillador de impacto manual - ranurado forma C 8 (5/16") 9 / 1 x Bit para destornillador de impacto manual - ranurado forma C 8 (5/16") 11
- 1 x Bit para destornillador de impacto manual - Phillips forma C 8 (5/16") PH2 / 1 x Bit para destornillador de impacto manual - Phillips forma C 8 (5/16") PH3
- 1 x Portabits de fuerza fijación mediante bola de hexágono exterior, cabezas cuadradas 1/2"
- 1 x Metallbox

**Destornillador de impacto manual**



hembra cuadrada 1/2"

24636

n° pdo.				€/unid.
32566	1/2"	163	1	78,44

**Portabits de fuerza fijación mediante bola**



de hexágono exterior, cabezas cuadradas 1/2"

72042

n° pdo.					€/unid.
32547	5/16"	1/2	38	5	13,33

Portabits Porta-Puntas con bloqueo mecánico



1/4", magnético en caja							7148CF
n° pdo.						€/unid.	
39133	1/4"	1/4"	60	-	10	23,76	

Portabits Porta-Puntas con bloqueo mecánico



de 1/4" en caja							7148
n° pdo.						€/unid.	
32477	1/4"	1/4"	60	-	10	22,63	

Portabits Porta-Puntas Super Slim con bloqueo mecánico



1/4" en caja							7148CS
n° pdo.						€/unid.	
39134	1/4"	1/4"	66	-	10	17,86	

Portabits MagicFlip Force magnético



con imán anular, de 1/4" en caja							7123
n° pdo.						€/unid.	
36800	1/4"	1/4"	62	-	10	23,76	

CUADRO INFORMATIVO:  
Sistemas de  
acoplamiento y bits  
adecuados



Portabits	adecuado para
CentroFix Force	Acoplamiento C 6,3, E 6,3 y 1/4"
SuperSlim	C 6,3
MagicFlip Force	C 6,3

CUADRO INFORMATIVO:  
Porta-Puntas  
SuperSlim



- Porta-Puntas SuperSlim
- Adecuado para todos los bits con acople hexagonal 1/4" con forma C 6,3 y E 6,3.
- SelfLock: Al insertar el bit se bloquea mecánicamente y se sujeta de forma segura.
- EasyOut: Al desbloquearlo, el bit se desplaza a una posición de extracción óptima.

CUADRO INFORMATIVO:  
Porta-Puntas  
SuperSlim



- Diámetro exterior reducido hasta un 30% en comparación con los soportes de cambio rápido "convencionales".
- Accesibilidad mejorada de los tornillos en agujeros ciegos de dimensiones estrechas.
- SelfLock: Al insertar el bit se bloquea mecánicamente y se sujeta de forma segura.
- EasyOut: Al desbloquearlo, el bit se desplaza a una posición de extracción óptima.

**Portabits magnético, fijación mediante anillo de retención**



1/4"		7143			
n° pdo.			mm		€/unid.
01913	1/4"	1/4"	72	2	10,83
36092	1/4"	1/4"	100	5	12,57
34306	1/4"	1/4"	150	5	14,09
36093	1/4"	1/4"	200	5	15,34
36094	1/4"	1/4"	250	5	18,24

**Portabits fijación mediante anillo de retención**



1/4"		7140			
n° pdo.			mm		€/unid.
01910	1/4"	1/4"	57	5	16,60

**Portabits magnético 74 mm**



1/4"		7113			
n° pdo.			mm		€/unid.
01894	1/4"	1/4"	74	10	9,79

**Portabits magnético 60 mm**



1/4" imán extra fuerte de en caja		7113P				
n° pdo.			mm			€/unid.
41922	1/4"	1/4"	60	-	6	9,14

**Portabits magnético 58 mm**



de 1/4"		7113S				
n° pdo.			mm			€/unid.
01895	1/4"	1/4"	58	-	10	5,26
07869	1/4"	1/4"	58	-	10	6,41

**Soporte universal, magnético/ anillo de retención, forma G 7.**



n° pdo.		7183			
		mm		€/unid.	
01919	1/4"	G7	72	2	18,24

**Portabits Industrial, con imán, media luna de 4 mm.**



n° pdo.		7110H			
	mm		€/unid.		
36112	4.0	50	10	25,03	

**CUADRO INFORMATIVO: MagicFlip Force**



- Facilita el atornillado de tornillos para construcciones de madera.
- Fuerza de sujeción óptima gracias al imán anular de neodimio especialmente potente.
- FlipBack: El casquillo de accionamiento salta automáticamente hacia atrás al penetrar el tornillo,
- Imán con./desc.: El imán anular se puede "desactivar" desplazando hacia atrás el casquillo de accionamiento.

**Destornillador con portabits SoftFinish® magnético**



de 1/4"							384
n° pdo.			mm			€/unid.	
01475	1/4"	125	243	36	10	22,76	
01476	1/4"	300	418	36	5	27,27	

**Destornillador con portabits SoftFinish® Porta-Puntas con bloqueo mecánico**



de 1/4"							387
n° pdo.			mm			€/unid.	
40331	1/4"	38	149	36	10	26,54	

**Destornillador con portabits SoftFinish® fijación mediante anillo de retención**



cuadrado							386
n° pdo.			mm			€/unid.	
01479	1/4"	150	265	36	10	20,88	

**Destornillador con portabits SoftFinish® magnético**



de 1/4"							281
n° pdo.			mm			€/unid.	
32160	1/4"	112	120	36	10	18,61	

**Destornillador con portabits SoftFinish® con soporte de cambio rápido**



de 1/4"							387
n° pdo.			mm			€/unid.	
25874	1/4"	35	146	30	10	24,88	

**Destornillador con portabits magnético**



Stubby, 1/4"							281
n° pdo.			mm			€/unid.	
29463	1/4"	57	65	34	10	14,09	

**Destornillador con portabits ESD**



**Stubby, 1/4" magnético**

281

n° pdo.						€/unid.
32484	1/4"	57	65	34	10	15,58

**Destornillador con mango corredizo y portabits magnético**



**de 1/4"**

388

n° pdo.					€/unid.
01481	1/4"	150	80	10	24,00

**Destornillador con portabits SoftFinish® ESD, con bloqueo mecánico**



**de 1/4"**

387

n° pdo.						€/unid.
32161	1/4"	38	148	30	10	42,13

**Destornillador con mango corredizo y dos portabits Comfort grip magnéticos**



**de 1/4"**

388DS

n° pdo.					€/unid.
26179	1/4"	150	100	10	31,18

**Mango del destornillador PicoFinish® ESD magnético**



**para micro bits de 4 mm**

281P

n° pdo.				€/unid.
43709	4.0	96	10	15,21

**Destornillador angular de alto rendimiento con soporte de cambio rápido 1/4"**



**1/4" en blíster**

24628

n° pdo.						€/unid.
32310	1/4"	1/4"	165	57.0	1	105,93

**Destornillador angular con portabits de magnético**



**1/4" en blíster**

24629

n° pdo.						€/unid.
32311	1/4"	1/4"	130	14.0	1	56,18



## **Mechanical Tools**

### **Atornillado firme - apertura fácil.**

Abrir tornillos firmemente apretados puede resultar enormemente dificultoso. Las llaves planas con carraca anular de Wiha permiten al usuario abrir fácilmente cualquier unión atornillada gracias al efecto palanca. Además, el extremo con boca resulta excelente para ejercer contrafuerza al apretar tornillos y tuercas. La carraca anular, con su hexágono doble y sus 72 dientes finos, ofrece un ángulo pequeño de recuperación y la máxima comodidad para trabajar en lugares con poco espacio.

El acreditado sistema de ordenación mediante L-Boxx con todos los tamaños corrientes de llaves de vaso combinados con diversos bits garantiza plena cobertura de trabajo y una movilidad sencilla.

Fabricadas en acero de cromo-vanadio de alta calidad, todas las herramientas son muy duraderas y robustas, y poseen una superficie de fácil limpieza resistente a la corrosión.



Para aplicaciones en la mecánica

**Juego de llaves de vaso y bits 1/4" y 1/2"**  
60 unid. con L-Boxx  
Página 266



**Juego de llaves de vaso y bits de 1/4"** Bolsa funcional de 40 unid. con clip para el cinturón  
Página 267



**Juego de llaves de carraca de 1/4"**  
17 unid. con plantilla de espuma  
Página 268



**Juego de llaves de carraca de 1/2"**  
26 unid. con plantilla de espuma  
Página 269



**Juego de llaves de carraca de 3/8"**  
23 unid. con plantilla de espuma  
Página 268



**Juego de llaves de boca con carraca angular**  
13 unid. conmutable con soporte  
Página 270



**Juego de llaves de boca con carraca angular**  
13 unid. con soporte  
Página 270



**Juego de llaves de boca con carraca angular**  
8 unid. con soporte  
Página 271



**Juego de llaves planas de doble boca**  
13 unid. con soporte  
Página 271





60 unid. con L-Boxx

33397

n° pdo.		€/unid.
44685		1 321,43
☐	Llave de carraca para llaves de vaso conmutable a 1/4" 1/4" x 128 mm (44666) / 1/2" x 257 mm (44709)	
○	Inserto de llave de vaso de hexágono exterior de 1/4" 4.0 mm (44669) / 5.0 mm (44670) / 5.5 mm (44671) / 6.0 mm (44672) / 7.0 mm (44673) / 8.0 mm (44674) / 9.0 mm (44675) / 10.0 mm (44676) / 11.0 mm (44678) / 12.0 mm (44679) / 13.0 mm (44680) / 14.0 mm (44681)	
○	Inserto de llave de vaso doble hexágono 1/2" 10.0 mm (44715) / 11.0 mm (44716) / 12.0 mm (44717) / 13.0 mm (44718) / 14.0 mm (44719) / 15.0 mm (44720) / 16.0 mm (44721) / 17.0 mm (44722) / 18.0 mm (44723) / 19.0 mm (44724) / 21.0 mm (44726) / 22.0 mm (44727) / 24.0 mm (44729) / 27.0 mm (44732) / 30.0 mm (44735) / 32.0 mm (44737) / 34.0 mm (44738)	
☐	Prolongación 1/4" para insertos de llave de vaso 75 mm (44667) / 150 mm (44668)	
☐	Prolongación 1/2" para insertos de llave de vaso 150 mm (44711) / 250 mm (44712)	
☐	Junta cardán con bola hembra cuadrada, cabeza cuadrada 1/4" (44682) / 1/2" (44739)	
○	Destornillador con portabits SoftFinish® magnético de 1/4" 112 mm (32160)	
○	Portabits Porta-Puntas con bloqueo mecánico 1/4", magnético en caja 60 mm (39133)	
⊖	Bit Standard de 25 mm ranurado de 1/4" C6,3 4.5 mm (01623) / 5.5 mm (01624) / 6.5 mm (01626)	
⊕	Bit Standard de 25 mm Phillips de 1/4" C6,3 PH1 (01657) / PH2 (01658)	
⊕	Bit Standard de 25 mm Pozidriv de 1/4" C6,3 PZ1 (01688) / PZ2 (01689) / PZ3 (01690)	
⊕	Bit Standard de 25 mm TORX® de 1/4" C6,3 T10 (01716) / T15 (01717) / T20 (01718) / T25 (01719) / T27 (01720) / T30 (01721) / T40 (01722)	
●	Bit Standard de 25 mm hexagonal de 1/4" C6,3 3.0 mm (01705) / 4.0 mm (01706) / 5.0 mm (01707) / 6.0 mm (01708)	
☐	Vástago de herramienta con bola Cuadrado interior, hexagonal interior de 1/4" C6,3 (01933)	
	L-BOXX	



**Bolsa funcional de 40 unid. con clip para el cinturón**

33394

n° pdo.	€/unid.
44684	1 149,43

- Llave de carraca para llaves de vaso conmutable a 1/4" 128 mm (44666)
  - Inserto de llave de vaso de hexágono exterior de 1/4" 4.0 mm (44669) / 4.5 mm (44677) / 5.0 mm (44670) / 5.5 mm (44671) / 6.0 mm (44672) / 7.0 mm (44673) / 8.0 mm (44674) / 9.0 mm (44675) / 10.0 mm (44676) / 11.0 mm (44678) / 12.0 mm (44679) / 13.0 mm (44680) / 14.0 mm (44681)
  - Prolongación 1/4" para insertos de llave de vaso 75 mm (44667) / 150 mm (44668)
  - junta cardán con bola hembra cuadrada, cabeza cuadrada 1/4" (44682)
  - Destornillador con portabits SoftFinish® magnético de 1/4" 112 mm (32160)
  - Portabits Porta-Puntas con bloqueo mecánico 1/4", magnético en caja 60 mm (39133)
  - ⊖ Bit Standard de 25 mm ranurado de 1/4" C6,3 4.5 mm (01623) / 5.5 mm (01624) / 6.5 mm (01626)
  - ⊕ Bit Standard de 25 mm Phillips de 1/4" C6,3 PH1 (01657) / PH2 (01658)
  - ⊕ Bit Standard de 25 mm Pozidriv de 1/4" C6,3 PZ1 (01688) / PZ2 (01689) / PZ3 (01690)
  - ⊕ Bit Standard de 25 mm TORX® de 1/4" C6,3 T10 (01716) / T15 (01717) / T20 (01718) / T25 (01719) / T27 (01720) / T30 (01721) / T40 (01722)
  - Bit Standard de 25 mm hexagonal de 1/4" C6,3 3.0 mm (01705) / 4.0 mm (01706) / 5.0 mm (01707) / 6.0 mm (01708)
  - Vástago de herramienta con bola Cuadrado interior, hexagonal interior de 1/4" C6,3 (01933)
- Bolsa de cinturón de herramientas

de acuerdo con la norma DIN 3124



Juego de llaves de carraca de 1/4"



Juego de llaves de carraca de 3/8"



1/4"

3/8"

17 unid. con plantilla de espuma

33391

n° pdo.	📦	€/unid.
44683	1	51,60

- Llave de carraca para llaves de vaso conmutable a 1/4" 128 mm (44666)
- Inserto de llave de vaso de hexágono exterior de 1/4" 4.0 mm (44669) / 4.5 mm (44677) / 5.0 mm (44670) / 5.5 mm (44671) / 6.0 mm (44672) / 7.0 mm (44673) / 8.0 mm (44674) / 9.0 mm (44675) / 10.0 mm (44676) / 11.0 mm (44678) / 12.0 mm (44679) / 13.0 mm (44680) / 14.0 mm (44681)
- Prolongación 1/4" para insertos de llave de vaso 75 mm (44667) / 150 mm (44668)
- Inserto de espuma

23 unid. con plantilla de espuma

33791

n° pdo.	📦	€/unid.
44708	1	73,10

- Llave de carraca para llaves de vaso conmutable a 3/8" 178 mm (44686)
- Inserto de llave de vaso doble hexágono 3/8" 6.0 mm (44690) / 7.0 mm (44691) / 8.0 mm (44692) / 9.0 mm (44693) / 10.0 mm (44694) / 11.0 mm (44695) / 12.0 mm (44696) / 13.0 mm (44697) / 14.0 mm (44698) / 15.0 mm (44699) / 16.0 mm (44700) / 17.0 mm (44701) / 18.0 mm (44702) / 19.0 mm (44703) / 20.0 mm (44704) / 21.0 mm (44705) / 22.0 mm (44706) / 24.0 mm (44707)
- Prolongación 3/8" para insertos de llave de vaso 75 mm (44687) / 150 mm (44688) / 250 mm (44689)
- Inserto de espuma

Juego de llaves de carraca de 1/2"



1/2"

26 unid. con plantilla de espuma

33891

n° pdo.		€/unid.
44740	1	101,05

- Llave de carraca para llaves de vaso conmutable a 1/2" 257 mm (44709)
- Inserto de llave de vaso doble hexágono 1/2" 8.0 mm (44713) / 9.0 mm (44714) / 10.0 mm (44715) / 11.0 mm (44716) / 12.0 mm (44717) / 13.0 mm (44718) / 14.0 mm (44719) / 15.0 mm (44720) / 16.0 mm (44721) / 17.0 mm (44722) / 18.0 mm (44723) / 19.0 mm (44724) / 20.0 mm (44725) / 21.0 mm (44726) / 22.0 mm (44727) / 23.0 mm (44728) / 24.0 mm (44729) / 25.0 mm (44730) / 26.0 mm (44731) / 27.0 mm (44732) / 28.0 mm (44733)
- Prolongación 1/2" para insertos de llave de vaso 75 mm (44710) / 150 mm (44711) / 250 mm (44712)
- Inserto de espuma



Juego de llaves de boca con carraca angular



13 unid. conmutable con soporte

303190

n° pdo.	🏠	€/unid.
44661	1	180,60

Llave de boca con carraca angular conmutables 8 mm x 8 mm (44641) / 9 mm x 9 mm (44642) / 10 mm x 10 mm (44644) / 11 mm x 11 mm (44645) / 12 mm x 12 mm (44646) / 13 mm x 13 mm (44647) / 14 mm x 14 mm (44648) / 15 mm x 15 mm (44789) / 16 mm x 16 mm (44649) / 17 mm x 17 mm (44650) / 18 mm x 18 mm (44651) / 19 mm x 19 mm (44652)

soporte

de acuerdo con la norma DIN 3124

Juego de llaves de boca con carraca angular



13 unid. con soporte

30391

n° pdo.	🏠	€/unid.
44665	1	137,60

Llave de boca con carraca angular 8 mm x 8 mm (44638) / 9 mm x 9 mm (44639) / 10 mm x 10 mm (44640) / 11 mm x 11 mm (44643) / 12 mm x 12 mm (44653) / 13 mm x 13 mm (44654) / 14 mm x 14 mm (44655) / 15 mm x 15 mm (44656) / 16 mm x 16 mm (44657) / 17 mm x 17 mm (44658) / 18 mm x 18 mm (44659) / 19 mm x 19 mm (44660)

soporte

de acuerdo con la norma DIN 3124

Juego de llaves de boca con carraca angular



8 unid. con soporte

30390

n° pdo.	🏠	€/unid.
44664	1	83,85

Llave de boca con carraca angular 9 mm x 9 mm (44639) / 10 mm x 10 mm (44640) / 11 mm x 11 mm (44643) / 12 mm x 12 mm (44653) / 13 mm x 13 mm (44654) / 14 mm x 14 mm (44655) / 15 mm x 15 mm (44656)

soporte

de acuerdo con la norma DIN 3124

Juego de llaves planas de doble boca



13 unid. con soporte

37390

n° pdo.	🏠	€/unid.
44753	1	106,43

Llaves de doble boca 6 mm x 7 mm (44741) / 8 mm x 9 mm (44742) / 10 mm x 11 mm (44743) / 12 mm x 13 mm (44744) / 14 mm x 15 mm (44745) / 16 mm x 17 mm (44746) / 18 mm x 19 mm (44747) / 20 mm x 22 mm (44748) / 21 mm x 23 mm (44749) / 24 mm x 27 mm (44750) / 25 mm x 28 mm (44849) / 30 mm x 32 mm (44752)

soporte

de acuerdo con la norma DIN 3124





## **Alicates**

### **Para mejorar el éxito de su salud.**

Los alicates de Wiha, combinan materiales de alta calidad con una comodidad ergonómica. El movimiento preciso de las articulaciones y la ejecución exacta de los filos de corte y de las superficies de agarre ofrecen la máxima funcionalidad. Cuentan con un diseño ergonómico y una fabricación de alta calidad, permitiendo así realizar un trabajo cómodo, protegiendo el cuerpo y, de este modo, también más eficiente.

El apoyo en tres puntos, OptiGrip, de los alicates universales y los alicates universales de fuerza, garantiza una sujeción óptima y segura para las operaciones de guiado y sujeción. Los alicates de arandelas de seguridad de la serie Classic, ofrecen un extra de estabilidad y seguridad con sus puntas de precisión MagicTips® de acero de alta calidad. En la línea Wiha Inomic® VDE, se protegen la articulación, los tendones y los músculos del usuario, a través de la forma acodada pronunciada de los alicates. Wiha, también ofrece herramientas adecuadas para desaislar, pelar y crimpar que facilitan el trabajo.



Para aplicaciones en la electricidad

**Alicates de instalación TriCut Professional electric 1/4" en blister**  
Página 275



**Alicates de corte diagonal de alto rendimiento BiCut® Professional con DynamicJoint® conmutables**  
Página 276



**Alicates de corte diagonal de fuerza Industrial electric con DynamicJoint® con resorte de apertura conectable y desconectable**  
Página 277



**Alicates universales Professional electric con DynamicJoint® y OptiGrip con filo de corte extralargo**  
Página 278



**Alicates de boca semi-redonda Professional electric con filo de corte, con forma recta**  
Página 279



**Sierra de arco electrico aislada con tres hojas de sierra de 150 mm**  
Página 285



**Pinza pico de loro Professional electric**  
Página 282



**crimpadora automática para terminales de cable, con presión cuadrada con cabezal de crimpado giratorio**  
Página 287



**Herramienta pelacable automática hasta 16 mm² en blister**  
Página 284



**Herramienta pelacables multiusos para cables redondos**  
Página 285



**Crimpadora automática para extremos de cables, con presión hexagonal**  
Página 286



Para aplicaciones en la mecánica

**Alicates de corte diagonal de alto rendimiento BiCut® Professional con DynamicJoint® conmutables**  
Página 291



**Alicates de corte diagonal de fuerza Professional con DynamicJoint® con resorte de apertura conectable y desconectable**  
Página 292



**Alicates universales Professional con DynamicJoint® y OptiGrip con filo de corte extralargo**  
Página 294



**Alicates de boca semi-redonda Professional con filo de corte, con forma curvada, aprox. 40°**  
Página 296



**Alicates de corte diagonal para plástico Classic con resorte de apertura sin chaflán**  
Página 297



**Tenazas llave Classic**  
Página 300



Para aplicaciones en la electrónica

**Juego de alicates Professional ESD con alicates de corte diagonal, de corte frontal transversal, alicates de boca semi-redonda, de 4 unid.**  
Página 308



**Alicates de boca semi-redonda Professional ESD con forma recta**  
Página 312



**Pinzas universales Professional ESD de tipo AA**  
Página 313



**Tenazas de puntas Electronic con cabeza corta estrecha con forma recta**  
Página 317



**Juego de alicates Professional electric**

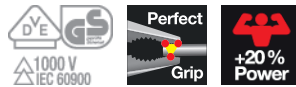

con alicates universales, de boca semi-redonda, alicates de corte diagonal, de 3 unid.

Z99000106

n° pdo.		€/unid.
26852	1	83,56

**Cortar a medida / cortar**

Alicates de corte diagonal Professional electric con DynamicJoint® 160 mm, 6 1/2" (43335)

**Transportar / sujetar**

Alicates universales Professional electric con DynamicJoint® y OptiGrip con filo de corte extralargo 180 mm, 7" (26708)

Alicates de boca semi-redonda Professional electric con filo de corte, con forma recta 200 mm, 8" (26727)

Fabricado de acuerdo con IEC 60900.

**Alicates juego Industrial electric**

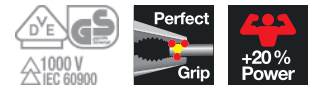

con alicates universales, de boca semi-redonda, alicates de corte diagonal, de 3 unid.

Z99000109

n° pdo.		€/unid.
38637	1	73,41

**Cortar a medida / cortar**

Alicates de corte diagonal Industrial electric con DynamicJoint® 160 mm, 6 1/2" (43336)

**Transportar / sujetar**

Alicates universales de fuerza Industrial electric con DynamicJoint® y OptiGrip con filo de corte extralargo 180 mm, 7" (33186)

Alicates de boca semi-redonda Industrial electric con filo de corte, con forma recta 200 mm, 8" (33178)

Fabricado de acuerdo con IEC 60900.

**Datos de potencia de corte**



**Ejemplo**

1 - 5	Cobre, aluminio
6 - 10	Clavos de hierro
11 - 15	Tornillos
16 - 21	Acero endurecido para resortes

## Alicates de instalación TriCut Professional electric



Z 14 1 06

n° pdo.	mm		✂	Ø mm	SB	⊞	€/unid.
38552	170	7"	13	1.6	-	5	43,58
38853	170	7"	13	1.6	x	5	45,19

Fabricado de acuerdo con IEC 60900.

## Alicates de instalación TriCut Classic



Z 14 1 01

n° pdo.	mm		✂	Ø mm	SB	⊞	€/unid.
38627	170	7"	13	1.6	-	5	32,47
38854	170	7"	13	1.6	x	5	34,08

## CUADRO INFORMATIVO: Herramientas homologadas según VDE



Las herramientas homologadas según VDE de Wiha se someten a procedimientos de control de seguridad estrictos.

Todas las herramientas con el distintivo especial han sido probadas a 10.000 V CA y están, por tanto, autorizadas para operar a 1.000 V CA y a 1.500 V CC.

Para todos los trabajos en la cercanía o con piezas sometidas a tensión deberá utilizar las medidas de protección que correspondan a cada trabajo:

- equipos de protección individual aislantes
- dispositivos de protección aislantes
- herramientas aisladas

Antes del comienzo de los trabajos en componentes activos de equipos eléctricos y medios de producción sometidos a tensión, deberá asegurarse de que no haya tensión y durante la realización de dichos trabajos.

Esto es así si se cumplen las cinco reglas de seguridad:

- Desconectar
- Asegurar que no haya reconexión
- Asegurarse de que no haya tensión
- Conectar a tierra y poner en cortocircuito
- Recubrir o aislar los componentes cercanos sometidos a tensión

Homologadas por el instituto de control y certificación VDE y comprobadas individualmente según la norma internacional IEC 60900:2012.

**Alicates de corte diagonal de aislamiento Professional electric con DynamicJoint®**



Z 14 0 06

n° pdo.	mm			Ømm	SB		€/unid.
26745	160	6 1/2"	13	1.6	-	5	41,68
27431	160	6 1/2"	13	1.6	x	5	43,29

Fabricado de acuerdo con IEC 60900.

**Alicates de corte diagonal Professional electric con DynamicJoint®**



Z 12 1 06

n° pdo.	mm			Ømm	SB		€/unid.
43326	140	5 1/2"	16	1.6	-	5	26,95
43453	140	5 1/2"	16	1.6	x	5	28,56
43335	160	6 1/2"	17	2	-	5	28,84
43458	160	6 1/2"	17	2	x	5	30,45
43340	180	7"	18	2.3	-	5	30,98
43463	180	7"	18	2.3	x	5	32,59

Fabricado de acuerdo con IEC 60900.

**Alicates de corte diagonal de alto rendimiento BiCut® Professional con DynamicJoint®**



Z 18 0 06

n° pdo.	mm			Ømm	SB		€/unid.
38191	200	8"	21	3	-	5	49,47
38984	200	8"	21	3	x	5	51,08

Fabricado de acuerdo con IEC 60900.

**Alicates de corte diagonal Industrial electric con DynamicJoint®**



Z 12 1 09

n° pdo.	mm			Ømm	SB		€/unid.
43327	140	5 1/2"	16	1.6	-	5	24,76
43454	140	5 1/2"	16	1.6	x	5	26,37
43336	160	6 1/2"	17	2	-	5	26,08
43459	160	6 1/2"	17	2	x	5	27,69
43341	180	6"	18	2.3	-	5	27,71
43464	180	7"	18	2.3	x	5	29,33

Fabricado de acuerdo con IEC 60900.

Alicates de corte diagonal de fuerza Professional electric con DynamicJoint®



con resorte de apertura conectable y desconectable

Z 16 3 06

n° pdo.	mm		✂	Ø mm	SB	🔌	€/unid.
41309	160	6 1/2"	17	2	x	5	39,02
40921	160	6 1/2"	17	2	-	5	37,41
41319	180	7"	18	2.3	x	5	41,97
41274	180	7"	18	2.5	-	5	40,36
41329	200	8"	19	2.8	x	5	44,62
41279	200	8"	19	2.8	-	5	43,01

Fabricado de acuerdo con IEC 60900.

Alicates de corte diagonal de fuerza Industrial electric con DynamicJoint®



con resorte de apertura conectable y desconectable

Z 16 3 09

n° pdo.	mm		✂	Ø mm	SB	🔌	€/unid.
40922	160	6 1/2"	17	2	-	5	32,87
41310	160	6 1/2"	17	2	x	5	34,49
41275	180	7"	18	2.5	-	5	35,54
41320	180	7"	18	2.5	x	5	37,15
41280	200	8"	19	2.8	-	5	38,55
41330	200	8"	19	2.8	x	5	40,16

Fabricado de acuerdo con IEC 60900.

CUADRO INFORMATIVO: DynamicJoint®



Wiha DynamicJoint® – La nueva dimensión de fuerza y duración

- Innovador: Construcción articulada única.
- Efectivo: Una menor pérdida de la fuerza se traduce en una menor fuerza necesaria para el corte.
- Durabilidad: Rendimiento óptimo incluso tras miles de cortes

CUADRO INFORMATIVO: Alicates de corte diagonal de fuerza



con resorte de apertura conectable y desconectable

- Fuerza de corte hasta un 40% mayor mediante una multiplicación de palanca optimizada.
- Resorte de apertura conectable y desconectable para trabajar sin fatigas.
- La activación del resorte de apertura se puede realizar con una mano.

Alicates universales Professional electric con DynamicJoint® y OptiGrip

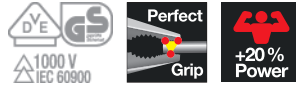

con filo de corte extralargo

Z 01 0 06

n° pdo.	mm	in	mm	mm	mm	mm	€/unid.
26705	160	6 1/2"	15	1.6	-	5	23,36
27328	160	6 1/2"	15	1.6	x	5	24,97
26708	180	7"	16	1.8	-	5	25,12
27418	180	7"	16	1.8	x	5	26,74
26711	200	8"	17	2	-	5	28,09
27419	200	8"	17	2	x	5	29,70

Fabricado de acuerdo con IEC 60900.

Alicates universales Professional electric con DynamicJoint® y OptiGrip

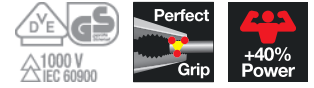

con filo de corte extralargo

Z 02 0 06

n° pdo.	mm	in	mm	mm	mm	mm	€/unid.
26714	200	8"	18	2.3	-	5	31,41
27420	200	8"	18	2.3	x	5	33,02
26717	225	9"	19	2.5	-	5	34,88
27421	225	9"	19	2.5	x	5	36,50

Fabricado de acuerdo con IEC 60900.

Alicates universales de fuerza Industrial electric con DynamicJoint® y OptiGrip

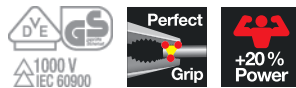

con filo de corte extralargo

Z 01 0 09

n° pdo.	mm	in	mm	mm	mm	mm	€/unid.
33186	180	7"	16	1.8	-	5	22,69
38855	180	7"	16	1.8	x	5	24,31

Fabricado de acuerdo con IEC 60900.

Alicates universales de fuerza Industrial electric con DynamicJoint® y OptiGrip

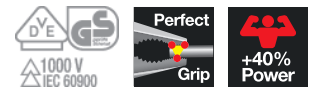

con filo de corte extralargo

Z 02 0 09

n° pdo.	mm	in	mm	mm	mm	mm	€/unid.
35465	225	9"	19	2.5	-	5	31,69
38856	225	9"	19	2.5	x	5	33,30

Fabricado de acuerdo con IEC 60900.

### Lineman's Pliers Industrial con DynamicJoint®



#### con filo de corte extralargo

Z 02 2 02

n° pdo.	mm		✂	Ø mm	SB	☒	€/unid.
40927	250	10"	20	2.5	-	5	44,87

### Alicates de boca semi-redonda Professional electric



#### con filo de corte, con forma recta

Z 05 0 06

n° pdo.	mm		✂	Ø mm	SB	☒	€/unid.
26720	160	6 1/2"	16	1.2	-	5	25,82
27422	160	6 1/2"	16	1.2	x	5	27,43
26727	200	8"	17	1.6	-	5	31,93
27423	200	8"	17	1.6	x	5	33,54

Fabricado de acuerdo con IEC 60900.

### Alicates de boca semi-redonda Industrial electric



#### con filo de corte, con forma recta

Z 05 0 09

n° pdo.	mm		✂	Ø mm	SB	☒	€/unid.
35477	160	6 1/2"	16	1.2	-	5	24,64
38857	160	6 1/2"	16	1.2	x	5	26,25
33178	200	8"	17	1.6	-	5	30,06
38858	200	8"	17	1.6	x	5	31,67

Fabricado de acuerdo con IEC 60900.

## CUADRO INFORMATIVO: OptiGrip

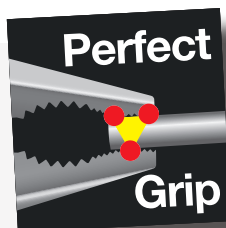

### Wiha OptiGrip: sujeción óptima gracias a la nueva forma de las superficies de agarre

- Sujeción segura: El »apoyo en tres puntos« evita la torsión o el movimiento de la pieza de trabajo.
- Eficaz: Sujeción óptima hasta con una abertura de boca grande y al mismo tiempo una aplicación de fuerza notablemente menor.
- Gran variedad: Ahora en alicates universales y alicates universales de fuerza estándar Wiha.

**Alicates de boca semi-redonda Professional electric**



**con filo de corte, con forma curvada, aprox. 40°** Z 05 1 06

n° pdo.	mm		✂	Ømm	SB	⊞	€/unid.
26728	160	6 1/2"	16	1.2	-	5	29,72
27424	160	6 1/2"	16	1.2	x	5	31,34
26729	200	8"	17	1.6	-	5	36,53
27425	200	8"	17	1.6	x	5	38,14

Fabricado de acuerdo con IEC 60900.

**Alicates de puntas planas Professional electric**



Z 07 0 06

n° pdo.	mm		SB	⊞	€/unid.
26732	160	6 1/2"	-	5	26,95
27426	160	6 1/2"	x	5	28,56

Fabricado de acuerdo con IEC 60900.

**Alicates de boca semi-redonda Industrial electric**



**con filo de corte, con forma curvada, aprox. 40°** Z 05 1 09

n° pdo.	mm		✂	Ømm	SB	⊞	€/unid.
35462	200	8"	17	1.6	-	5	33,52
38859	200	8"	17	1.6	x	5	35,13

Fabricado de acuerdo con IEC 60900.

**Alicates de puntas redondas Professional electric**

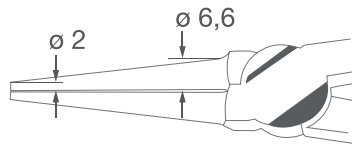

Z 09 0 06

n° pdo.	mm		SB	⊞	€/unid.
26735	160	6 1/2"	-	5	26,56
27427	160	6 1/2"	x	5	28,18

Fabricado de acuerdo con IEC 60900.



### Alicates para corte de cables Professional electric



### Alicates para corte de cables Classic



#### con resorte de apertura conectable y desconectable

Z 50 3 06

n° pdo.	mm	7"	mm <sup>2</sup>	SB	5	€/unid.
43660	180	7"	50	-	5	37,78
43664	180	7"	50	x	5	39,39
43662	210	8 1/4"	60	-	5	43,46
43666	210	8 1/4"	60	x	5	45,07

Fabricado de acuerdo con IEC 60900.

Z 50 2 01

n° pdo.	mm	7"	mm <sup>2</sup>	SB	5	€/unid.
43538	180	7"	50	-	5	25,84
43544	180	7"	50	x	5	27,46
43541	210	8 1/4"	60	-	5	33,09
43547	210	8 1/4"	60	x	5	34,70

### Alicates para corte de cables Industrial electric



#### con resorte de apertura conectable y desconectable

Z 50 3 09

n° pdo.	mm	7"	mm <sup>2</sup>	SB	5	€/unid.
43661	180	7"	50	-	5	33,64
43665	180	7"	50	x	5	35,25
43663	210	8 1/4"	60	-	5	39,04
43667	210	8 1/4"	60	x	5	40,66

Fabricado de acuerdo con IEC 60900.



**Pinza pico de loro Professional electric**



Z 25 0 06

n° pdo.	mm		⊙	⊙	SB	⊞	€/unid.
44314	250	10"	46 mm			5	71,38

Fabricado de acuerdo con IEC 60900.

**Alicates pelacables Professional electric**



Z 55 0 06

n° pdo.	mm		∅ mm	mm <sup>2</sup>	SB	⊞	€/unid.
26847	160	6 1/2"	5	10	-	5	29,62
27437	160	6 1/2"	5	10	x	5	31,23

Fabricado de acuerdo con IEC 60900.

**Alicates para fontanería Professional electric**



Z 21 0 06

**deslizados**

n° pdo.	mm		⊙	⊙	SB	⊞	€/unid.
33520	250	10"	2"	50 mm	-	5	33,88
38631	250	10"	2"	50 mm	x	5	35,50

**Alicates pelacables Industrial electric**



Z 55 0 09

n° pdo.	mm		∅ mm	mm <sup>2</sup>	SB	⊞	€/unid.
36711	160	6 1/2"	5	10	-	5	27,71
38867	160	6 1/2"	5	10	x	5	29,33

Fabricado de acuerdo con IEC 60900.

**Alicates para fontanería Professional electric**



Z 22 0 06

**con ajuste del pulsador**

n° pdo.	mm		⊙	⊙	SB	⊞	€/unid.
37450	250	10"	2"	50	-	5	43,41
38632	250	10"	2"	50	x	5	45,02

Fabricado de acuerdo con IEC 60900.

### Alicates pelacables Professional



Z 55 0 05

n° pdo.	mm		Ø mm	mm <sup>2</sup>	SB		€/unid.
26846	160	6 1/2"	5	10	-	5	25,61

### Alicates pelacables Industrial



Z 55 0 02

n° pdo.	mm		Ø mm	mm <sup>2</sup>	SB		€/unid.
32345	160	6 1/2"	5	10	-	5	23,42
34313	160	6 1/2"	5	10	x	5	25,04

### Alicates pelacables Classic



Z 55 0 01

n° pdo.	mm		Ø mm	mm <sup>2</sup>	SB		€/unid.
26845	160	6 1/2"	5	10	-	5	18,61
27368	160	6 1/2"	5	10	x	5	20,22



### Herramienta pelacable automática



#### hasta 16 mm<sup>2</sup> en blíster

Z 57 0 06

n° pdo.	mm		Ø mm	AWG	SB	☒	€/unid.
42062	200	8"	0.03 - 16	32 - 5	x	1	144,85

### Herramienta pelacable automática



#### hasta 6 mm<sup>2</sup>

Z 57 5 06

n° pdo.	mm		Ø mm	AWG	SB	☒	€/unid.
44617	190	7 1/2"	0.2 - 6	24 - 10	x	1	38,74

### Herramienta pelacable con cuchilla de arrastre autogirable



#### para cables redondos

Z 72 0 06

n° pdo.	mm		Ø mm	SB	☒	€/unid.
44618	165	6 1/2"	4 - 28	-	1	19,18
44619	165	6 1/2"	4 - 28	x	1	20,79

### Juego de cuchillas de repuesto y de mordazas de agarre

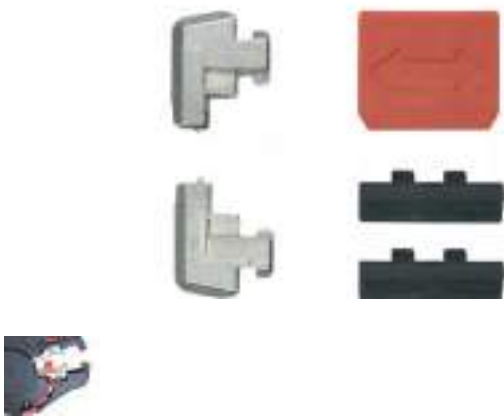

#### para herramienta pelacable automática (42062)

Z57000106K

n° pdo.	☒	€/unid.
42162	2	35,78

### CUADRO INFORMATIVO: Herramienta pelacable automática hasta 16 mm<sup>2</sup>



- Los alicates cubren un amplio ancho de banda para cables y reúne de esto modo dos alicates en uno.
- El atenuador suministrado adjunto puede utilizarse para reducir el contragolpe en grandes secciones transversales de cables (p. ej. a partir de 6 mm<sup>2</sup>) y para proteger las muñecas.
- Cortar a medida de forma precisa gracias al tope longitudinal ajustable.
- La protección para la mano integrada en el filo de corte previene las lesiones.

### Herramienta pelacable con cuchilla de arrastre autogirable



para cables redondos

Z 72 0 06

n° pdo.	mm	↔	Ø mm	SB	📦	€/unid.
44240	130	5 1/8"	4 - 28	x	1	16,13

### Sierra de arco electrico



aislada con tres hojas de sierra de 150 mm

246176

n° pdo.	mm	↔	SB	📦	€/unid.
43125	150	280	x	1	46,89

### Herramienta pelacable



para cables redondos

Z 73 0 06

n° pdo.	mm	↔	Ø mm	SB	📦	€/unid.
44620	140	5 1/2"	6 - 13	x	1	23,75

### Cuchillo pelacables



con filo de corte recto para cables redondos, en blíster

24680

n° pdo.	mm	↔	SB	📦	€/unid.
38798	200	8"	x	1	15,96

Fabricado de acuerdo con IEC 60900.

### Herramienta pelacables y de montaje



para cables coaxiales con conector F

Z 73 2 06

n° pdo.	mm	↔	Ø mm	SB	📦	€/unid.
44241	125	5"	6 - 8	x	1	29,89

### Cuchillo pelacables



con cuchilla de gancho con patín de guía para cables redondos, en blíster

24678

n° pdo.	mm	↔	SB	📦	€/unid.
36053	200	8"	x	1	35,67

Fabricado de acuerdo con IEC 60900.

### Herramienta pelacables multiusos



para cables redondos

Z 74 0 06

n° pdo.	mm	↔	Ø mm	AWG	SB	📦	€/unid.
44242	125	5"	0.5 - 6	20 - 10	x	1	34,19

### Alicates para manguitos terminales Classic



Z 60 0 01

n° pdo.	mm	in	mm <sup>2</sup>	SB	Icon	€/unid.
28330	145	5 3/4"	0.25 - 2.5	-	5	25,48
30066	180	7"	0.25 - 16	-	5	33,70

### Alicates para manguitos terminales Professional electric



1000 V  
IEC 60900

Z 60 0 06

n° pdo.	mm	in	mm <sup>2</sup>	SB	Icon	€/unid.
35862	180	7"	0.25 - 16	-	5	39,16
38986	180	7"	0.25 - 16	x	5	40,77

Fabricado de acuerdo con IEC 60900.

### Alicates para manguitos terminales Professional electric



1000 V  
IEC 60900

Z 60 0 06

n° pdo.	mm	in	mm <sup>2</sup>	SB	Icon	€/unid.
35861	145	5 3/4"	0.25 - 2.5	-	5	30,62
38985	145	5 3/4"	0.25 - 2.5	x	5	32,23

Fabricado de acuerdo con IEC 60900.

### Crimpadora automática



#### para extremos de cables, con presión hexagonal

Z 62 0 06

n° pdo.	mm	Ø mm	AWG	Icon	€/unid.
41246	210	0.08 - 16	28 - 5	1	196,78

Para el mecanizado de casquillos Twin y extremos de cables con y sin cuello aislante conforme a DIN 46228, EN 50027

### crimpadora automática



para terminales de cable, con presión cuadrada con cabezal de crimpado giratorio

Z 62 0 06

n° pdo.	mm	Ø mm	AWG	SB	€/unid.
45223	193	0.08 - 16	28 - 5	1	195,00

Para el mecanizado de virolas de cable con y sin cuello aislante conforme a DIN 46228, EN 50027.

### Crimpadoras



para terminales de cables y contactos aislados

Z 62 0 06

n° pdo.	mm	Ø mm	AWG	SB	€/unid.
33841	220	0.5 - 6	20 - 10	1	114,41

Para el procesamiento de terminales de cables aislados rojos, azules y amarillos, terminales de cables unipolares, enchufes planos, casquillos de enchufes planos, clavijas coaxiales, casquillos de clavijas coaxiales, conectores de choque y conectores paralelos según DIN 46234.

### Crimpadoras



para extremos de cables

Z 62 0 06

n° pdo.	mm	Ø mm	AWG	SB	€/unid.
33844	220	0.14 - 16	26 - 5	-	122,01

40342	220	0.14 - 16	26 - 5	x	123,63
-------	-----	-----------	--------	---	--------

Para el mecanizado de virolas de cable con y sin cuello aislante conforme a DIN 46228, EN 50027.

### Crimpadoras



para terminales de cables no aislados con casquillo cerrado

Z 62 0 06

n° pdo.	mm	Ø mm	AWG	SB	€/unid.
33843	220	0.1 - 16	26 - 6	1	122,01

Para el mecanizado de terminales de cable no aislados, terminales de cables unipolares, conectores de choque y microterminales de cables según DIN 46234/ DIN 46230/ DIN 46341.

### Crimpadoras



para enchufes planos no aislados

Z 62 0 06

n° pdo.	mm	Ø mm	AWG	🏠	€/unid.
33842	220	0.25 - 6	24 - 10	1	122,01

Para el procesamiento de enchufes planos no aislados y casquillos de enchufes planos según DIN 46247 para uniones eléctricas según las normas, sin soldaduras.

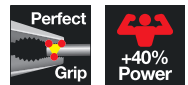

### Cizalla para artesano



con función de crimpado en blíster

Z 71 7 06

n° pdo.	mm	mm <sup>2</sup>	🏠	€/unid.
41923	160	50	5	34,00

### Cizalla para artesano



en modelo estándar de acero inoxidable

Z 71 5 06

n° pdo.	mm		🏠	€/unid.
29420	145	5 3/4"	5	12,72

### Juego de alicates Classic



Alicates universales de fuerza, alicates para fontanería, alicates de corte diagonal de fuerza, de 3 unid.

Z99000201

n° pdo.	🏠	€/unid.
26853	1	76,21

Alicates universales Classic con DynamicJoint® y OptiGrip con filo de corte extralargo 200 mm, 8" (26712)

Alicates de corte diagonal de fuerza Classic con DynamicJoint® 180 mm, 7" (41261)

Alicates para fontanería QuickFix Classic automático 250 mm, 10" (39091)



Juego de alicates Classic

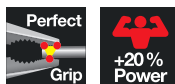

con alicates universales, de boca semi-redonda, alicates de corte diagonal, de 3 unid.

Z99000101

n° pdo.		€/unid.
26850	1	46,57

Alicates universales Classic con DynamicJoint® y OptiGrip con filo de corte extralargo 180 mm, 7" (26706)

Alicates de corte diagonal Classic con DynamicJoint® 160 mm, 6 1/2" (43332)

Alicates de boca semi-redonda Classic con filo de corte, con forma recta 160 mm, 6 1/2" (26718)

Juego de alicates Professional

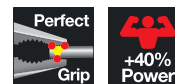

Alicates universales de fuerza, alicates para fontanería, alicates de corte diagonal de fuerza, de 3 unid.

Z99000205

n° pdo.		€/unid.
26854	1	101,46

Alicates universales Professional con DynamicJoint® y OptiGrip con filo de corte extralargo 200 mm, 8" (26713)

Alicates de corte diagonal de fuerza Professional con DynamicJoint® con resorte de apertura conectable y desconectable 180 mm, 7" (41273)

Alicates para fontanería QuickFix Professional automático 250 mm, 10" (39093)



**Juego de alicates Classic con MagicTips®**





**con alicates de arandelas de seguridad, de 4 unid.**

Z99000701

n° pdo.		€/St.
34708	1	71,19

**Transportar / sujetar**

	Alicates de arandelas de seguridad Classic con MagicTips® para anillos interiores (taladros) J 1, 140 mm (34689) / J 2, 180 mm (34690)
	Alicates de arandelas de seguridad Classic con MagicTips® para anillos exteriores (ejes) A 1, 140 mm (34699) / A 2, 185 mm (34700)

con función de trinquete de seguridad MagicTips®



**Juego de alicates Classic**



**con alicates de arandelas de seguridad, de 4 unid.**

Z99000401

n° pdo.		€/St.
26793	1	56,10

	Alicates de arandelas de seguridad Classic para anillos interiores (taladros) J 1, 140 mm (26782) / J 2, 180 mm (26783)
	Alicates de arandelas de seguridad Classic para anillos exteriores (ejes) A 1, 140 mm (26790) / A 2, 180 mm (26791)

**CUADRO INFORMATIVO:  
MagicTips®**



**MagicTips® de Wiha – El primero de su clase.**

- Excelente sujeción: La función especial de trinquete para evitar que salten los anillos de seguridad convierte a los alicates de arandelas de seguridad de Wiha en únicos.
- Duro como el acero: gran resistencia al desgaste y como consecuencia, gran durabilidad, gracias al endurecimiento adicional de las puntas.
- Precisos: Las puntas de precisión utilizada son de acero especial de alta calidad para ofrecer la mejor sujeción y estabilidad.

Alicates de corte diagonal de alto rendimiento BiCut® Professional con DynamicJoint®



conmutables Z 18 0 05

n° pdo.	mm	8"	21	3	SB	5	€/unid.
38190	200	8"	21	3	-	5	43,61
38983	200	8"	21	3	x	5	45,23

Alicates de corte diagonal de alto rendimiento BiCut® Classic con DynamicJoint®



conmutables Z 18 0 01

n° pdo.	mm	8"	21	3	SB	5	€/unid.
38981	200	8"	21	3	x	5	36,69
38060	200	8"	21	3	-	5	35,08

Alicates de corte diagonal de alto rendimiento BiCut® Industrial con DynamicJoint®



conmutables Z 18 0 02

n° pdo.	mm	8"	21	3	SB	5	€/unid.
38189	200	8"	21	3	-	5	39,44
38982	200	8"	21	3	x	5	41,05

CUADRO INFORMATIVO:  
Alicates Professional  
Alicates Industrial

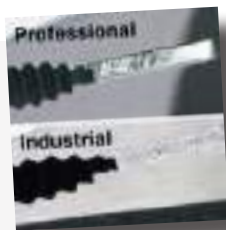

Professional Industrial

Professional: Alicates cromados

Industrial: Alicates pulidos / negro oxidado



Alicates de corte diagonal Professional con DynamicJoint®



Z 12 1 05

n° pdo.	mm	in	mm	mm	SB	mm	€/unid.
43325	140	5 1/2"	16	1.6	-	5	24,23
43334	160	6 1/2"	17	2	-	5	25,17
43457	160	6 1/2"	17	2	x	5	26,78
43339	180	7"	18	2.3	-	5	27,47

Alicates de corte diagonal Classic con DynamicJoint®



Z 12 1 01

n° pdo.	mm	in	mm	mm	SB	mm	€/unid.
43304	140	5 1/2"	16	1.6	-	5	16,97
43450	140	5 1/2"	16	1.6	x	5	18,59
43332	160	6 1/2"	17	2	-	5	17,09
43455	160	6 1/2"	17	2	x	5	18,71
43337	180	7"	18	2.3	-	5	18,86
43460	180	7"	18	2.3	x	5	20,47

Alicates de corte diagonal Industrial con DynamicJoint®



Z 12 1 02

n° pdo.	mm	in	mm	mm	SB	mm	€/unid.
43324	140	5 1/2"	16	1.6	-	5	21,99
43451	140	5 1/2"	16	1.6	x	5	23,61
43333	160	6 1/2"	17	2	-	5	22,50
43456	160	6 1/2"	17	2	x	5	24,11
43338	180	7"	18	2.3	-	5	24,25
43461	180	7"	18	2.3	x	5	25,86

Alicates de corte diagonal de fuerza Professional con DynamicJoint®



con resorte de apertura conectable y desconectable

Z 16 3 05

n° pdo.	mm	in	mm	mm	SB	mm	€/unid.
40920	160	6,5"	17	2	-	5	33,51
41273	180	7"	18	2.5	-	5	36,56
41318	180	7"	18	2.5	x	5	38,17
41278	200	8"	19	2.8	-	5	38,54

**Alicates de corte diagonal de fuerza Industrial con DynamicJoint®**



**con resorte de apertura conectable y desconectable**

Z 16 3 02

n° pdo.	mm		✂	Ø mm	SB	☰	€/unid.
40919	160	6,5"	17	2	-	5	28,95
41307	160	6,5"	17	2	x	5	30,56
41272	180	7"	18	2.5	-	5	31,73
41317	180	7"	18	2.5	x	5	33,35
41277	200	8"	19	2.8	-	5	33,86
41327	200	8"	19	2.8	x	5	35,48

**Alicates de corte diagonal de fuerza Classic con DynamicJoint®**



Z 16 2 01

n° pdo.	mm		✂	Ø mm	SB	☰	€/unid.
40913	160	6,5"	17	2	-	5	21,85
41301	160	6,5"	17	2	x	5	23,47
41261	180	7"	18	2.5	-	5	24,10
41311	180	7"	18	2.5	x	5	25,71
41266	200	8"	19	2.8	-	5	26,48
41321	200	8"	19	2.8	x	5	28,09

**CUADRO INFORMATIVO:  
Alicates de corte diagonal de fuerza**



**con resorte de apertura conectable y desconectable**

- Fuerza de corte hasta un 40% mayor mediante una multiplicación de palanca optimizada.
- Resorte de apertura conectable y desconectable para trabajar sin fatigas.
- La activación del resorte de apertura se puede realizar con una mano.

Alicates universales Professional con DynamicJoint® y OptiGrip

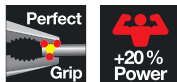

con filo de corte extralargo

Z 01 0 05

n° pdo.	mm		✂	Ø mm	SB	☒	€/unid.
26704	160	6 1/2"	16	1.6	-	5	20,22
27327	160	6 1/2"	16	1.6	x	5	21,83
26707	180	7"	16	1.8	-	5	21,22
27399	180	7"	16	1.8	x	5	22,83
26710	200	8"	17	2	-	5	24,40

Alicates universales Industrial con DynamicJoint® y OptiGrip

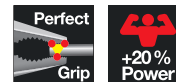

con filo de corte extralargo

Z 01 0 02

n° pdo.	mm		✂	Ø mm	SB	☒	€/unid.
30979	160	6 1/2"	16	1.6	-	5	17,98
34565	160	6 1/2"	16	1.6	x	5	19,60
30826	180	7"	16	1.8	-	5	18,36
34307	180	7"	16	1.8	x	5	19,97
30978	200	8"	17	2	-	5	21,11
34308	200	8"	17	2	x	5	22,73

CUADRO INFORMATIVO:  
DynamicJoint®



Wiha DynamicJoint® – La nueva dimensión de fuerza y duración

- Innovador: Construcción articulada única.
- Efectivo: Una menor pérdida de la fuerza se traduce en una menor fuerza necesaria para el corte.
- Durabilidad: Rendimiento óptimo incluso tras miles de cortes

CUADRO INFORMATIVO:  
OptiGrip

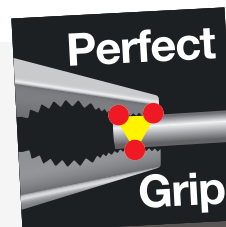

Wiha OptiGrip: sujeción óptima gracias a la nueva forma de las superficies de agarre

- Sujeción segura: El »apoyo en tres puntos« evita la torsión o el movimiento de la pieza de trabajo.
- Eficaz: Sujeción óptima hasta con una abertura de boca grande y al mismo tiempo una aplicación de fuerza notablemente menor.
- Gran variedad: Ahora en alicates universales y alicates universales de fuerza estándar Wiha.

Alicates universales Classic con DynamicJoint® y OptiGrip

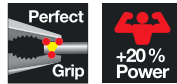

con filo de corte extralargo

Z 01 0 01

n° pdo.	mm		✂	Ø mm	SB	☰	€/unid.
26703	160	6 1/2"	16	1.6	-	5	13,23
27325	160	6 1/2"	16	1.6	x	5	14,85
26706	180	7"	16	1.8	-	5	14,11
27336	180	7"	16	1.8	x	5	15,73
26709	200	8"	17	2	-	5	16,35
27337	200	8"	17	2	x	5	17,96

Alicates universales Industrial con DynamicJoint® y OptiGrip

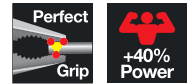

con filo de corte extralargo

Z 02 0 02

n° pdo.	mm		✂	Ø mm	SB	☰	€/unid.
32319	200	8"	18	2.3	-	5	24,37
32320	225	9"	19	2.5	-	5	28,49
34567	225	9"	19	2.5	x	5	30,10

Alicates universales Professional con DynamicJoint® y OptiGrip

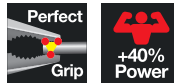

con filo de corte extralargo

Z 02 0 05

n° pdo.	mm		✂	Ø mm	SB	☰	€/unid.
26713	200	8"	18	2.3	-	5	27,85
26716	225	9"	19	2.5	-	5	31,83

Alicates universales Classic con DynamicJoint® y OptiGrip

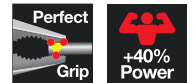

con filo de corte extralargo

Z 02 0 01

n° pdo.	mm		✂	Ø mm	SB	☰	€/unid.
26712	200	8"	18	2.3	-	5	19,86
26715	225	9"	19	2.5	-	5	22,84



### Alicates de boca semi-redonda Professional



#### con filo de corte, con forma recta

Z 05 0 05

n° pdo.	mm		✂	Ømm	SB	☒	€/unid.
26719	160	6 1/2"	16	1.2	-	5	22,21
26722	200	8"	17	1.6	-	5	27,85

### Alicates de boca semi-redonda Classic



#### con filo de corte, con forma recta

Z 05 0 01

n° pdo.	mm		✂	Ømm	SB	☒	€/unid.
26718	160	6 1/2"	16	1.2	-	5	16,97
27340	160	6 1/2"	16	1.2	x	5	18,59
26721	200	8"	17	1.6	-	5	22,09
27341	200	8"	17	1.6	x	5	23,70

### Alicates de boca semi-redonda Industrial



#### con filo de corte, con forma recta

Z 05 0 02

n° pdo.	mm		✂	Ømm	SB	☒	€/unid.
32322	160	6 1/2"	16	1.2	-	5	20,86
34309	160	6 1/2"	16	1.2	x	5	22,47
32323	200	8"	17	1.6	-	5	25,85
34515	200	8"	17	1.6	x	5	27,47

### Alicates de boca semi-redonda Professional



#### con filo de corte, con forma curvada, aprox. 40°

Z 05 1 05

n° pdo.	mm		✂	Ømm	SB	☒	€/unid.
26724	160	6 1/2"	16	1.2	-	5	26,11
26726	200	8"	17	1.6	-	5	32,35



**Alicates de boca semi-redonda Industrial**



**con filo de corte, con forma curvada, aprox. 40°** Z 05 1 02

n° pdo.	mm		✂	Ømm	SB	🏠	€/unid.
32324	160	6 1/2"	16	1.2	-	5	23,98
34569	160	6 1/2"	16	1.2	x	5	25,60
32328	200	8"	17	1.6	-	5	28,73
34570	200	8"	17	1.6	x	5	30,35

**Alicates de corte diagonal para plástico Classic**

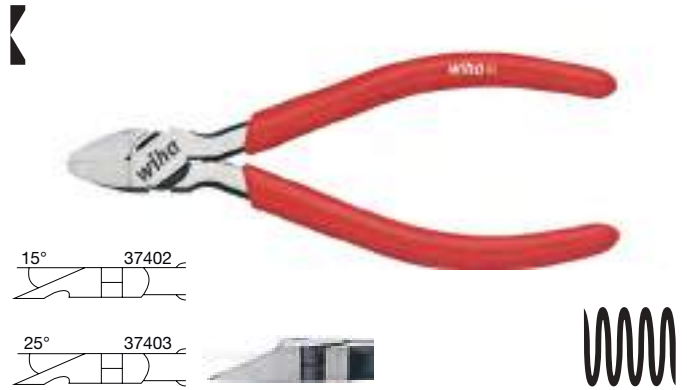

**con resorte de apertura sin chaflán** Z 15 0 01

n° pdo.	mm		✂	🏠	€/unid.
37402	125	5"	2	5	21,85
37403	160	6 1/2"	3	5	22,65

**Alicates de boca semi-redonda Classic**



**con filo de corte, con forma curvada, aprox. 40°** Z 05 1 01

n° pdo.	mm		✂	Ømm	SB	🏠	€/unid.
26723	160	6 1/2"	16	1.2	-	5	19,97
27342	160	6 1/2"	16	1.2	x	5	21,59
26725	200	8"	17	1.6	-	5	24,96
27343	200	8"	17	1.6	x	5	26,57

**Alicates de boca semi-redonda para mecánicos de precisión Classic**



**con filo de corte y resorte de apertura, con forma recta** Z 36 0 01

n° pdo.	mm		✂	Ømm	🏠	€/unid.
36483	160	6 1/2"	10	2	5	22,21



Alicates de corte diagonal para mecánicos de precisión Classic



con resorte de apertura

Z 44 3 01

n° pdo.	mm	in	mm	mm	SB	€ /unid.
36189	125	5"	7	0.8	-	22,84
43240	125	5"	7	0.8	x	24,46

Alicates de puntas planas Industrial



Z 07 0 02

n° pdo.	mm	in	SB	€ /unid.
32330	160	6 1/2"	-	21,37
34310	160	6 1/2"	x	22,98

Alicates de puntas planas Professional



Z 07 0 05

n° pdo.	mm	in	SB	€ /unid.
26731	160	6 1/2"	-	24,16

Alicates de puntas planas Classic



Z 07 0 01

n° pdo.	mm	in	SB	€ /unid.
26730	160	6 1/2"	-	17,31
27344	160	6 1/2"	x	18,92

### Alicates de puntas redondas Professional

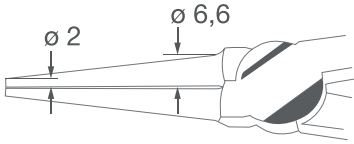

Z 09 0 05

n° pdo.	mm		SB	🏠	€/unid.
26734	160	6 1/2"	-	5	23,35

### Alicates de puntas redondas Classic

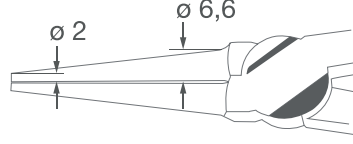

Z 09 0 01

n° pdo.	mm		SB	🏠	€/unid.
26733	160	6 1/2"	-	5	17,04
27345	160	6 1/2"	x	5	18,65

### Alicates de puntas redondas Industrial

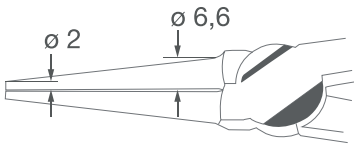

Z 09 0 02

n° pdo.	mm		SB	🏠	€/unid.
32332	160	6 1/2"	-	5	21,01
34568	160	6 1/2"	x	5	22,62



### Tenazas llave Classic



Z 25 0 01

n° pdo.	mm	11	⊙	⊙	⊞	€/unid.
40923	250	10"	46 mm		5	59,97

### Alicates para fontanería Industrial



Z 21 0 02

#### deslizados

n° pdo.	mm	11	⊙	⊙	SB	⊞	€/unid.
36038	180	7"	1 1/2"	36 mm	-	5	23,75
36985	180	7"	1 1/2"	36 mm	x	5	25,36
32342	250	10"	2"	50 mm	-	5	25,93
34312	250	10"	2"	50 mm	x	5	27,54
36039	300	12"	2 1/2"	63 mm	-	5	34,97
36986	300	12"	2 1/2"	63 mm	x	5	36,58

### Alicates para fontanería Profesional



Z 21 0 05

#### deslizados

n° pdo.	mm	11	⊙	⊙	⊞	€/unid.
26762	250	10"	2"	50 mm	5	31,09

### Alicates para fontanería Classic



Z 21 0 01

#### deslizados

n° pdo.	mm	11	⊙	⊙	SB	⊞	€/unid.
26760	180	7"	1 1/2"	36 mm	-	5	19,22
27350	180	7"	1 1/2"	36 mm	x	5	20,83
26761	250	10"	2"	50 mm	-	5	20,10
27381	250	10"	2"	50 mm	x	5	21,72
26763	300	12"	2 1/2"	63 mm	-	5	30,71
27382	300	12"	2 1/2"	63 mm	x	5	32,33

## CUADRO INFORMATIVO: Tenaza



- El ajuste del ancho de llave necesario directamente en la pieza de trabajo sin necesidad de pulsar ningún botón
- El principio de trinquete permite el atornillado rápido mediante el deslizamiento sencillo.
- Gracias a la construcción estrecha y al ajuste sin botón es ideal para trabajar en lugares estrechos.
- Las mordazas lisas y dispuestas en paralelo evitan los daños en las superficies sensibles.

### Alicates para fontanería Profesional



22 0 05

#### con botón

n° pdo.	mm	11	⊙	⊙	⊞	€/unid.
26766	250	10"	2"	50 mm	5	39,18

### Alicates para fontanería Classic



#### con botón

Z 22 0 01

n° pdo.	mm		○	⊗	SB	⊞	€/unid.
26764	180	7"	1"	36 mm	-	5	25,23
27351	180	7"	1"	36 mm	x	5	26,84
26765	250	10"	2"	50 mm	-	5	26,91
27383	250	10"	2"	50 mm	x	5	28,52
26767	300	12"	2 1/2"	63 mm	-	5	37,08
27384	300	12"	2 1/2"	63 mm	x	5	38,69

### Alicates para fontanería QuickFix Professional



#### automático

Z 23 0 05

n° pdo.	mm		○	⊗	SB	⊞	€/unid.
39093	250	10"	1 1/2"	40 mm	-	5	43,20
39095	250	10"	1 1/2"	40 mm	x	5	44,82

### Alicates para fontanería Industrial



#### con botón

Z 22 0 02

n° pdo.	mm		○	⊗	SB	⊞	€/unid.
36040	180	7"	1"	30 mm	-	5	29,46
36987	180	7"	1"	30 mm	x	5	31,07
32352	250	10"	2"	50 mm	-	5	31,55
34518	250	10"	2"	50 mm	x	5	33,16
36041	300	12"	2 1/2"	63 mm	-	5	43,97
36988	300	12"	2 1/2"	63 mm	x	5	45,58

### Alicates para fontanería QuickFix Classic



#### automático

Z 23 0 01

n° pdo.	mm		○	⊗	SB	⊞	€/unid.
39091	250	10"	1 1/2"	40 mm	-	5	34,34
39094	250	10"	1 1/2"	40 mm	x	5	35,95



### Alicates de corte diagonal frontal Classic



Z 17 0 01

n° pdo.	mm		✂	Ømm	SB	🏠	€/unid.
26757	160	6 1/2"	16	1.6	-	5	13,39
27372	160	6 1/2"	16	1.6	x	5	15,01
26758	180	7"	17	1.8	-	5	15,90
27373	180	7"	17	1.8	x	5	17,51
26759	200	8"	18	2	-	5	19,88
27374	200	8"	18	2	x	5	21,49

### Tenazas rusas Classic



Z 31 0 01

n° pdo.	mm		✂	Ømm	SB	🏠	€/unid.
26774	220	8 3/4"	16	1.6	-	5	15,28
27377	220	8 3/4"	16	1.6	x	5	16,89
26776	250	10"	17	1.8	-	5	16,80
27378	250	10"	17	1.8	x	5	18,41
26778	280	11"	18	2	-	5	18,46
27379	280	11"	18	2	x	5	20,07
26780	300	12"	18	2	-	5	22,15
27380	300	12"	18	2	x	5	23,76

### Tenazas Classic



Z 30 0 01

n° pdo.	mm		✂	Ømm	SB	🏠	€/unid.
26771	180	7"	12	2	-	5	14,73
27375	180	7"	12	2	x	5	16,34
26772	200	8"	13	2.2	-	5	15,56
27376	200	8"	13	2.2	x	5	17,17

### Tenazas rusas Classic



sin revestimiento del mango

Z 31 0 00

n° pdo.	mm		✂	Ømm	SB	🏠	€/unid.
26773	220	8 3/4"	16	1.6	-	5	14,65
27501	220	8 3/4"	16	1.6	x	5	16,26
26775	250	10"	17	1.8	-	5	16,03
27502	250	10"	17	1.8	x	5	17,64
26777	280	11"	18	2	-	5	17,55
27503	280	11"	18	2	x	5	19,17
26779	300	12"	18	2	-	5	20,88
27504	300	12"	18	2	x	5	22,49

### Tenazas rusas de fuerza Classic



Z 32 0 01

n° pdo.	mm	12"	19	Ø mm	SB	5	€/unid.
40712	300	12"	19	2.3	-	5	26,07
41220	300	12"	19	2.3	x	5	27,68

### Tenazas rusas de fuerza Classic Plus



sin revestimiento del mango

Z 32 0 10

n° pdo.	mm	12"	19	Ø mm	SB	5	€/unid.
40713	300	12"	19	2.3	-	5	28,13
41221	300	12"	19	2.3	x	5	29,75



Alicates de arandelas de seguridad Classic con MagicTips®



para anillos interiores (taladros)

Z 33 4 01

n° pdo.		mm	↔	☉	SB	☰	€/unid.
34688	J 0	140	5 1/2"	8 - 13	-	5	17,00
36975	J 0	140	5 1/2"	8 - 13	x	5	18,61
34689	J 1	140	5 1/2"	12 - 25	-	5	17,00
36225	J 1	140	5 1/2"	12 - 25	x	5	18,61
34690	J 2•	180	7"	19 - 60	-	5	17,83
36222	J 2•	180	7"	19 - 60	x	5	19,45
34691	J 3•	220	9"	40 - 100	-	5	20,17
36272	J 3•	220	9"	40 - 100	x	5	21,78
34692	J 4•	305	12"	85 - 140	-	5	34,88

•con función de trinquete de seguridad MagicTips®  
DIN ISO 5256

Alicates de arandelas de seguridad Classic con MagicTips®



para anillos exteriores (ejes)

Z 34 4 01

n° pdo.		mm	↔	☉	SB	☰	€/unid.
34698	A 0	140	5 1/2"	3 - 10	-	5	19,59
36977	A 0	140	5 1/2"	3 - 10	x	5	21,20
34699	A 1	140	5 1/2"	10 - 25	-	5	18,35
36978	A 1	140	5 1/2"	10 - 25	x	5	19,96
34700	A 2•	185	7"	19 - 60	-	5	20,37
36220	A 2•	185	7"	19 - 60	x	5	21,98
34701	A 3•	240	9"	100 - 40	-	5	22,11
36219	A 3•	240	9"	100 - 40	x	5	23,73
34702	A 4•	300	12"	140 - 85	-	5	38,85

•con función de trinquete de seguridad MagicTips®  
DIN ISO 5256

Alicates de arandelas de seguridad Classic con MagicTips®



para anillos interiores (taladros)

Z 33 5 01

n° pdo.		mm	↔	☉	SB	☰	€/unid.
34693	J 01	140	5 1/2"	8 - 13	-	5	19,40
36976	J 01	140	5 1/2"	8 - 13	x	5	21,02
34694	J 11	140	5 1/2"	12 - 25	-	5	19,40
36223	J 11	140	5 1/2"	12 - 25	x	5	21,02
34695	J 21•	180	7"	19 - 60	-	5	19,59
36224	J 21•	180	7"	19 - 60	x	5	21,20
34696	J 31•	220	9"	40 - 100	-	5	21,60
36226	J 31•	220	9"	40 - 100	x	5	23,21
34697	J 41•	305	12"	85 - 140	-	5	37,28

•con función de trinquete de seguridad MagicTips®  
DIN ISO 5256

Alicates de arandelas de seguridad Classic con MagicTips®



para anillos exteriores (ejes)

Z 34 5 01

n° pdo.		mm	↔	☉	SB	☰	€/unid.
34703	A 01	140	5 1/2"	3 - 10	-	5	21,34
36979	A 01	140	5 1/2"	3 - 10	x	5	22,95
34704	A 11	140	5 1/2"	10 - 25	-	5	20,17
36980	A 11	140	5 1/2"	10 - 25	x	5	21,78
34705	A 21•	185	7"	19 - 60	-	5	22,11
36218	A 21•	185	7"	19 - 60	x	5	23,73
34706	A 31•	240	9"	40 - 100	-	5	24,26
36221	A 31•	240	9"	40 - 100	x	5	25,88
34707	A 41•	300	12"	85 - 140	-	5	42,22

•con función de trinquete de seguridad MagicTips®  
DIN ISO 5256



**Alicates de arandelas de seguridad Classic**



**para anillos interiores (taladros)**

Z 33 0 01

n° pdo.		mm				€/unid.
26781	J 0	140	5 1/2"	8 - 13	5	13,33
26782	J 1	140	5 1/2"	12 - 25	5	13,33
26783	J 2	180	7"	19 - 60	5	14,21
26784	J 3	225	9"	40 - 100	5	16,37
29425	J 4	310	12"	85 - 140	5	27,66

DIN ISO 5256

**Alicates de arandelas de seguridad Classic**



**para anillos interiores (taladros)**

Z 33 1 01

n° pdo.		mm				€/unid.
26785	J 01	140	5 1/2"	8 - 13	5	15,23
26786	J 11	140	5 1/2"	12 - 25	5	15,23
26787	J 21	180	7"	19 - 60	5	15,62
26788	J 31	225	9"	40 - 100	5	17,38
29427	J 41	310	12"	85 - 140	5	29,56

DIN ISO 5256

**Alicates de arandelas de seguridad Classic**



**para anillos exteriores (ejes)**

Z 34 0 01

n° pdo.		mm				€/unid.
26789	A 0	140	5 1/2"	3 - 10	5	15,62
26790	A 1	140	5 1/2"	10 - 25	5	14,73
26791	A 2	180	7"	19 - 60	5	16,24
26792	A 3	225	9"	40 - 100	5	17,78
29428	A 4	310	12"	85 - 140	5	31,10

DIN ISO 5256

**Alicates de arandelas de seguridad Classic**



**para anillos exteriores (ejes)**

Z 34 1 01

n° pdo.		mm				€/unid.
26794	A 01	140	5 1/2"	3 - 10	5	17,01
26795	A 11	140	5 1/2"	10 - 25	5	16,11
26796	A 21	180	7"	19 - 60	5	17,64
26797	A 31	225	9"	40 - 100	5	19,54
29429	A 41	310	12"	85 - 140	5	33,38

DIN ISO 5256

**CUADRO INFORMATIVO: MagicTips®**



**MagicTips® de Wiha – El primero de su clase.**

- Excelente sujeción: La función especial de trinquete para evitar que salten los anillos de seguridad convierte a los alicates de arandelas de seguridad de Wiha en únicos.
- Duro como el acero: gran resistencia al desgaste y como consecuencia, gran durabilidad, gracias al endurecimiento adicional de las puntas.
- Precisos: Las puntas de precisión utilizada son de acero especial de alta calidad para ofrecer la mejor sujeción y estabilidad.

Llave para apretar tubos en ángulos Classic



con boca en S

Z 26 0 00

n° pdo.	mm	Ø	↖ ↗	🏠	€/unid.
29435	335	1"	0 - 50	1	42,70
29436	430	1 1/2"	0 - 60	1	60,30
29437	545	2"	0 - 80	1	93,51

Tenazas perforadoras revólver Professional



Z 65 0 05

n° pdo.	mm	↔	●	🏠	€/unid.
28402	225	9"	2 - 4.5	5	19,17

Llave para apretar tubos en ángulos Classic



de 90°

Z 26 2 00

n° pdo.	mm	Ø	↖ ↗	🏠	€/unid.
29441	320	1"	0 - 50	1	42,70
29442	415	1 1/2"	0 - 60	1	57,68
29443	540	2"	0 - 80	1	88,40

Tenazas perforadoras revólver Professional



Z 65 2 05

n° pdo.	mm	↔	●	🏠	€/unid.
29550	225	9"	4 - 5	5	20,53

### Tenazas grip Classic



#### con cortacables

Z 66 0 00

n° pdo.	mm	"	○	□	🏠	€/unid.
29485	180	7"	8 - 30	0 - 20	5	22,53
29486	250	10"	8 - 40	0 - 20	5	22,27
29487	300	12"	8 - 65	0 - 30	5	40,80

### Cortador de pernos Classic



Z 27 0 01

n° pdo.	mm	"	✂️	Ømm	🏠	€/unid.
39374	450	18"	6	6	1	57,33
39376	600	24"	7	8	1	73,14
39378	750	30"	8	9	1	91,18
39380	900	36"	9	11	1	111,16

### Cabeza de corte de repuesto



#### para cortador de pernos Classic

Z 27 0 01K

n° pdo.	✂️	Ømm	🏠	€/unid.
39375	6	6	1	32,05
39377	7	8	1	46,88
39379	8	9	1	59,26
39381	9	11	1	69,19



**Juego de alicates Professional ESD**



**con alicates de corte diagonal, de corte frontal transversal, alicates de boca semi-redonda, de 5 unid. incl. carpeta de herramientas**

Z99000104

n° pdo.		€/unid.
33507	1	186,42
		Alicates de corte diagonal Professional ESD con cabeza puntiaguda ancha sin chaflán 115 mm, 4 1/2" (26821)
		Alicates de corte diagonal Professional ESD con cabeza semi-redonda ancha con chaflán 115 mm, 4 1/2" (26831)
		Alicates de corte frontal transversal Professional ESD con cabeza ancha, aprox. 29 °, con chaflán pequeño 115 mm, 4 1/2" (26835)
		Alicates de boca semi-redonda Professional ESD con forma recta 120 mm, 4 3/4" (26799)
		Kit de herramientas

**Juego de pinzas SMD Professional ESD**



**en surtido de 5 unid. incl. caja**

ZP99014002

n° pdo.		€/unid.
32349	1	98,99
		Pinzas universales Professional ESD de tipo AA 130 mm (32318)
		Pinzas de precisión Professional ESD de tipo PSF 130 mm (32325)
		Pinzas SMD Professional ESD de tipo 13 120 mm (32340)
		Pinzas SMD Professional ESD de tipo 59 117 mm (32344)
		Caja

**CUADRO INFORMATIVO:  
Herramientas con derivación electrostática ESD**

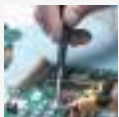

**Los componentes electrónicos sensibles pueden resultar dañados de forma irreparable incluso con la menor tensión.**

- Las herramientas disipadoras de Wiha derivan la energía eléctrica de forma controlada y segura.
- Las herramientas ESD cumplen la norma ESD IEC 61340-5-1.
- Los mangos de las herramientas ESD tienen una resistencia superficial de  $10^6 - 10^9$  ohmios.

Alicates de corte diagonal Professional ESD

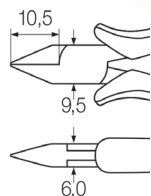

con cabeza puntiaguda estrecha con chaflán pequeño

Z 40 1 04

n° pdo.	mm	in		Ø mm	SB		€/unid.
26808	115	4 1/2"	7	0.6	-	5	42,39
27442	115	4 1/2"	7	0.6	x	5	44,00

DIN ISO 9654. IEC 61340-5-1.

Alicates de corte diagonal Professional ESD

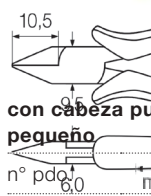

con cabeza puntiaguda estrecha con chaflán pequeño

Z 40 4 04

n° pdo.	mm	in		Ø mm	SB		€/unid.
26814	115	4 1/2"	2	1	-	5	44,39
27443	115	4 1/2"	2	1	x	5	46,00

DIN ISO 9654. IEC 61340-5-1.

Alicates de corte diagonal Professional ESD

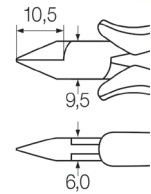

con cabeza puntiaguda estrecha sin chaflán

Z 40 3 04

n° pdo.	mm	in		Ø mm		€/unid.
33521	115	4 1/2"	2	1	5	44,27

DIN ISO 9654. IEC 61340-5-1.

Alicates de corte diagonal Professional ESD

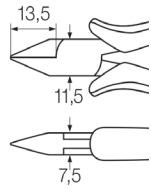

con cabeza puntiaguda ancha con chaflán

Z 41 1 04

n° pdo.	mm	in		Ø mm	SB		€/unid.
26816	115	4 1/2"	7	1	-	5	42,84
27444	115	4 1/2"	7	1	x	5	44,45

DIN ISO 9654. IEC 61340-5-1.



Alicates de corte diagonal Professional ESD



con cabeza puntiaguda ancha sin chaflán

Z 41 3 04

n° pdo.	mm	in	SB	mm	SB	mm	€/unid.
26821	115	4 1/2"	2	1	-	5	43,74
27445	115	4 1/2"	2	1	x	5	45,35

DIN ISO 9654. IEC 61340-5-1.

Alicates de corte diagonal Professional ESD



con cabeza semi-redonda estrecha con chaflán pequeño

Z 43 1 04

n° pdo.	mm	in	SB	mm	SB	mm	€/unid.
26826	115	4 1/2"	2	1.2	-	5	41,12
27447	115	4 1/2"	2	1.2	x	5	42,73

DIN ISO 9654. IEC 61340-5-1.

Alicates de corte diagonal Professional ESD



con cabeza puntiaguda ancha y muelle de sujeción de cable con chaflán pequeño

Z 41 4 04

n° pdo.	mm	in	SB	mm	SB	mm	€/unid.
26822	115	4 1/2"	2	1.2	-	5	43,68
27446	115	4 1/2"	2	1.2	x	5	45,29

DIN ISO 9654. IEC 61340-5-1.

Alicates de corte diagonal Professional ESD



con cabeza semi-redonda ancha con chaflán

Z 44 1 04

n° pdo.	mm	in	SB	mm	SB	mm	€/unid.
26831	115	4 1/2"	7	1	-	5	40,87
27448	115	4 1/2"	7	1	x	5	42,48

DIN ISO 9654. IEC 61340-5-1.

**Alicates de corte diagonal Professional ESD**



**con cabeza semi-redonda ancha con chaflán pequeño**

Z 44 3 04

n° pdo.	mm		✂	Ømm	SB	☒	€/unid.
26832	115	4 1/2"	2	1.2	-	5	41,12
27449	115	4 1/2"	2	1.2	x	5	42,73

DIN ISO 9654. IEC 61340-5-1.

**Alicates de corte frontal Professional ESD**



**con cabeza estrecha con chaflán pequeño**

Z 47 1 04

n° pdo.	mm		✂	Ømm	SB	☒	€/unid.
26839	110	4 1/4"	2	0.6	-	5	47,13
27452	110	4 1/4"	2	0.6	x	5	48,74

DIN ISO 9654. IEC 61340-5-1.

**Alicates de corte frontal transversal Professional ESD**



**con cabeza ancha, aprox. 29°, con chaflán pequeño**

Z 46 1 04

n° pdo.	mm		✂	Ømm	SB	☒	€/unid.
26835	115	4 1/2"	2	1.2	-	5	50,66
27450	115	4 1/2"	2	1.2	x	5	52,28

DIN ISO 9654. IEC 61340-5-1.

**Alicates de corte frontal Professional ESD**



**con cabeza ancha con chaflán pequeño**

Z 47 2 04

n° pdo.	mm		✂	Ømm	SB	☒	€/unid.
26840	115	4 1/2"	2	1.4	-	5	46,63
27453	115	4 1/2"	2	1.4	x	5	48,25

DIN ISO 9654. IEC 61340-5-1.

### Alicates de boca semi-redonda Professional ESD



#### con forma recta

Z 36 0 04

n° pdo.	mm		SB	€/unid.
26799	120	4 3/4"	-	35,36
27329	120	4 3/4"	-	36,97
27905	145	5 3/4"	-	39,28

### Alicates redondos Professional ESD



#### con mordazas redondas cortas

Z 37 0 04

n° pdo.	mm		SB	€/unid.
26804	120	4 3/4"	-	35,36
27440	120	4 3/4"	x	36,97

DIN ISO 9654. IEC 61340-5-1.

### Alicates de boca semi-redonda Professional ESD



#### con forma curvada, aprox. 45°

Z 36 1 04

n° pdo.	mm		SB	€/unid.
26802	120	4 3/4"	-	38,31
27439	120	4 3/4"	x	39,93

DIN ISO 9654. IEC 61340-5-1.

### Alicates planos Professional ESD



#### con mordazas planas cortas

Z 38 0 04

n° pdo.	mm		SB	€/unid.
26806	120	4 3/4"	-	35,36
27441	120	4 3/4"	x	36,97

DIN ISO 9654. IEC 61340-5-1.



**Pinzas universales Professional ESD**



**de tipo AA**

ZP 01 0 14

n° pdo.	mm		🏠	€/unid.
32318	130	AA	10	13,27

IEC 61340-5-1.

**Pinzas de precisión Professional ESD**



**de tipo SS**

ZP 09 0 14

n° pdo.	mm		🏠	€/unid.
32326	135	SS	10	20,33

IEC 61340-5-1.

**Pinzas de precisión Professional ESD**



**de tipo GG**

ZP 06 0 14

n° pdo.	mm		🏠	€/unid.
32347	130	GG	10	19,10

IEC 61340-5-1.

**Pinzas de precisión Professional ESD**



**de tipo 00**

ZP 11 0 14

n° pdo.	mm		🏠	€/unid.
32327	120	0	10	25,29

IEC 61340-5-1.

**Pinzas de precisión Professional ESD**



**de tipo PSF**

ZP 07 1 14

n° pdo.	mm		🏠	€/unid.
32325	130	PSF	10	16,36

IEC 61340-5-1.

**Pinzas de precisión Professional ESD**



**de tipo 2a**

ZP 15 0 14

n° pdo.	mm		🏠	€/unid.
32329	120	2a	10	18,22

IEC 61340-5-1.



**Pinzas de precisión Professional ESD**



**de tipo 3c**

ZP 16 0 14

n° pdo.	mm			€/unid.
32346	110	3c	10	18,22

IEC 61340-5-1.

**Pinzas de precisión Professional ESD**



**de tipo 7abb**

ZP 20 2 14

n° pdo.	mm			€/unid.
32336	120	7abb	10	27,65

IEC 61340-5-1.

**Pinzas de precisión Professional ESD**



**de tipo 5**

ZP 18 0 14

n° pdo.	mm			€/unid.
32334	110	5	10	19,77

IEC 61340-5-1.

**Pinzas SMD Professional ESD**



**de tipo 12**

ZP 24 0 14

n° pdo.	mm			€/unid.
32338	120	12	10	25,18

IEC 61340-5-1.

**Pinzas de precisión Professional ESD**



**de tipo 7a**

ZP 20 1 14

n° pdo.	mm			€/unid.
32335	120	7a	10	21,58

IEC 61340-5-1.

**Pinzas SMD Professional ESD**



**de tipo 13**

ZP 25 2 14

n° pdo.	mm			€/unid.
32340	120	13	10	25,29

IEC 61340-5-1.

## Pinzas universales Professional ESD



### de tipo 40

ZP 46 0 14

n° pdo.	mm			€/unid.
32343	145	40	10	17,98

IEC 61340-5-1.

## Pinzas SMD Professional ESD



### de tipo 59

ZP 50 0 14

n° pdo.	mm			€/unid.
32344	117	59	10	21,76

IEC 61340-5-1.



Alicates de corte diagonal Electronic

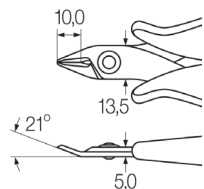

con cabeza puntiaguda ancha sin chaflán

Z 41 1 03

n° pdo.	mm		✂	Ømm	SB	☒	€/unid.
26818	130	5 1/2"	3	1.3	-	5	20,76
27391	130	5 1/2"	3	1.3	x	5	22,37

Alicates de corte diagonal Electronic

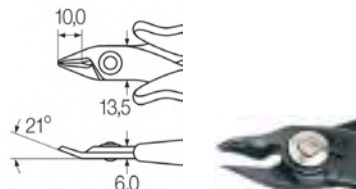

con cabeza puntiaguda ancha y muelle de sujeción de cable sin chaflán

Z 41 6 03

n° pdo.	mm		✂	Ømm	SB	☒	€/unid.
26825	130	5 1/8"	3	1.3	-	5	22,94
27395	130	5 1/8"	3	1.3	x	5	24,55

Alicates de corte diagonal Electronic

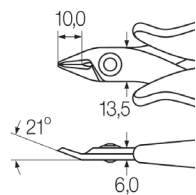

con cabeza puntiaguda ancha con chaflán pequeño

Z 41 3 03

n° pdo.	mm		✂	Ømm	SB	☒	€/unid.
26815	135	5 1/3"	8	0.8	-	5	29,09
27393	135	5 1/3"	8	0.8	x	5	30,70

Alicates de corte diagonal Electronic

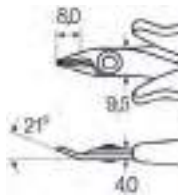

con cabeza puntiaguda muy estrecha sin chaflán

Z 40 0 03

n° pdo.	mm		✂	Ømm	SB	☒	€/unid.
26812	128	5 1/8"	2	0.8	-	5	21,10
27388	128	5 1/8"	2	0.8	x	5	22,71

### Alicates de corte diagonal Electronic



con cabeza puntiaguda estrecha y muelle de sujeción de cable sin chaflán

Z 40 1 03

n° pdo.	mm			Ø mm			€/unid.
26813	126	5"	2	1	-	5	23,77
27390	126	5"	2	1	x	5	25,38

### Alicates de corte frontal transversal Electronic



con cabeza corta muy estrecha sin chaflán

Z 46 0 03

n° pdo.	mm			Ø mm			€/unid.
26830	125	5"	2	0,6	-	5	26,97
27397	125	5"	2	0,6	x	5	28,58

### Alicates de corte frontal transversal Electronic



con cabeza puntiaguda ancha sin chaflán

Z 46 0 03

n° pdo.	mm			Ø mm			€/unid.
26833	130	5 1/8"	3	1,3	-	5	21,24
27398	130	5 1/8"	3	1,3	x	5	22,85

### Tenazas de puntas Electronic



con cabeza corta estrecha con forma recta

Z 36 0 03

n° pdo.	mm					€/unid.
26801	135	5 1/3"	-	-	5	22,54
27326	135	5 1/3"	x	-	5	24,16

## Tenazas de puntas Electronic

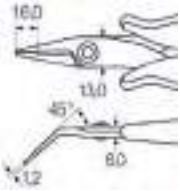

con cabeza larga estrecha, con forma curvada, aprox. 40°

Z 36 1 03

n° pdo.	mm	↔	SB	☒	€/unid.
41015	133	5 1/4"	-	5	31,16
41222	133	5 1/4"	x	5	32,78

## Alicates pelacables Electronic

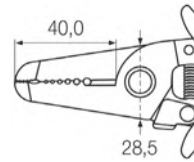

Estaciones pelacables de 0,4-1,3 mm

Z 49 2 03

n° pdo.	mm	↔	Ømm	AWG	SB	☒	€/unid.
33472	165	6 1/2"	0,4 - 1,3	26 - 16	-	5	24,65
35820	165	6 1/2"	0,4 - 1,3	26 - 16	x	5	26,26

## Alicates pelacables Electronic

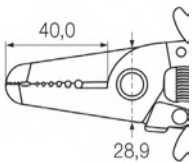

Estaciones pelacables de 0,8-2,6 mm<sup>2</sup>

Z 49 2 03

n° pdo.	mm	↔	Ømm	AWG	SB	☒	€/unid.
33471	165	6 1/2"	0,8 - 2,6	20 - 10	-	5	24,65
36794	165	6 1/2"	0,8 - 2,6	20 - 10	x	5	26,26



# Las potencias de corte de nuestros alicates.

Alambre blando Plástico, cobre, aluminio, cable eléctrico, alambre de plata fino					Alambre semi-duro Clavos de hierro, tornillos de latón, valla de tela metálica				
1	2	3	4	5	6	7	8	9	10
		Alicates de corte diagonal para plástico						Alicates de boca semi-redonda para mecánicos de precisión	
		Alicates de corte diagonal Electronic					Alicates de corte diagonal para mecánicos de precisión		
		Alicates de corte transversal Electronic						Alicates de corte diagonal Electronic con chafán	
		Micro-alcates de corte frontal transversal Electronic							
		Micro-alcates de corte diagonal Electronic							
		Alicates de corte frontal ESD						Alicates de corte diagonal ESD con chafán	
		Alicates de corte frontal transversal ESD							
		Alicates de corte diagonal ESD							



**Alambre duro**

Tornillos, cable de alambre, cesta de rejilla de alambre, carriles para electricistas

**Acero endurecido**

Resortes, pasadores endurecidos, cadenas

✂ 11

12

13

14

15

✂ 16

17

18

19

20

✂ 21

Alicates de instalación TriCut

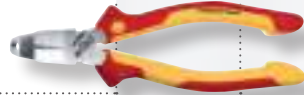

Alicates de corte diagonal para electricistas

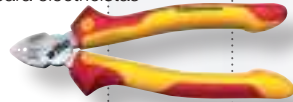

Tenazas



Lineman's Pliers



BiCut® Alicates de corte diagonal 100% /

200 %

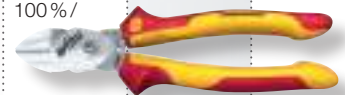

Tenazas rusas de fuerza

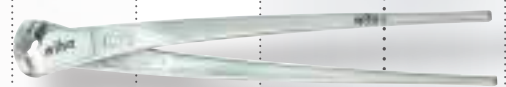

Alicates universales de fuerza

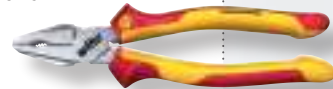

Alicates universales

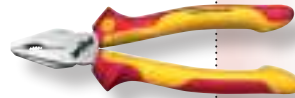

Alicates de corte diagonal



Alicates de corte diagonal de fuerza



Alicates de corte diagonal frontal



Tenazas rusas



Alicates de boca semi-redonda

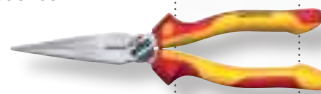

Alicates de boca semiredonda curvados

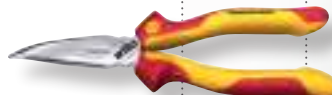



### **Herramienta de impacto y de medición**

#### **Transmisión de fuerzas óptima y trabajo a medida preciso.**

El martillo de electricista de Wiha, con una distribución del peso equilibrada de forma óptima, promete un balance perfecto y es ideal también para el uso en entornos de trabajo estrechos. La colocación de cables y espigas sin ocasionar daños y la retirada de clavos y de abrazaderas de clavos se convierten en un juego de niños. El destornillador-perforador de agujeros para espigas de Wiha portátil permite, gracias a la varilla del destornillador con escala, un agujero para espigas perfectamente dimensionado en la profundidad deseada – en cualquier momento y en cualquier lugar, sin polvo ni suciedad en comparación con el uso de máquinas.

Las herramientas de medición de Wiha han demostrado ser ayudantes fiables en las instalaciones eléctricas. Con el nivel de burbuja de aire para electricistas de Wiha se pueden marcar distancias de forma sencilla para hasta cuatro cajas empotrables. El nivel de burbuja de aire permite medir con facilidad y ofrece una visión perfecta de los niveles de burbuja.

Herramientas de percusión

**Juego de martillos de cara blanda Safety con surtido de cabezales, de 8 unid., en caja**  
Página 324



**Martillo de cara blanda Safety de dureza media/duro con mango de madera Hickory, cabezal redondo**  
Página 325



**Martillo de fragua sin contragolpe, semiduro con mango de madera Hickory, cabezal redondo**  
Página 328



**Martillo de cara blanda sin contragolpe, semiduro con tubo de acero, cabezal redondo**  
Página 328



**Martillo de electricista con cabeza del martillo de 300 g, en blíster**  
Página 330



**Juego de destornilladores-perforadores de agujeros para espigas SoftFinish® con espigas con varilla redonda de 6 mm, en blíster, de 5 unid.**  
Página 330



Instrumentos de medición

**Nivel de burbuja de aire para electricistas de 40 cm**  
Página 331



**Pie de rey digiMax® digital con lectura de 0,01 mm**  
Página 332



**Metro plegable para electricista Longlife 2 m métrico, de 10 eslabones**  
Página 332



**Metro plegable LongLife® Plus Composite de 2 m métrico, de 10 eslabones**  
Página 332





con surtido de cabezales, de 8 unid., en caja

832B801

n° pdo.



€/unid.

44008

1

74,45

- 1 x Cabezal blando redondo para martillo de cara blanda Safety
- 2 x Cabezal dureza media redondo para martillo de cara blanda Safety
- 2 x Cabezal semiduro redondo para martillo de cara blanda Safety
- 2 x Cabezal duro redondo para martillo de cara blanda Safety
- 1 x Cabezal muy duro redondo para martillo de cara blanda Safety
- 1 x Mango de madera Hickory para martillo de cara blanda Safety
- 1 x Juego de carcasas para martillos con tornillo y tuerca de seguridad para martillo de cara blanda Safety
- 1 x 6.0 mm

## INFOBOX:

### Sistema de colores de los cabezales de Wiha



#### Indicación de seguridad:

- Al trabajar con un martillo de cabezal blando utilice siempre gafas y guantes de protección. Además, tenga en cuenta las normas y prescripciones nacionales.
- Utilice los siguientes pares de apriete para cambiar el cabezal o el mango:

Tamaño 30 = 20 Nm  
 Tamaño 40 = 40 Nm  
 Tamaño 50 = 70 Nm  
 Tamaño 60 = 70 Nm  
 Tamaño 80 = 80 Nm



#### Cabezal

#### Campo de aplicación

blando (azul)

para materiales sensibles, p. ej. para la construcción de muebles y las obras interiores, los trabajos de montaje ligeros. Material: Elastómero.

dureza media (negro)

aplicación universal, p. ej. para la construcción de herramientas y máquinas, la reparación de vehículos, los trabajos de chapa y de montaje. Material: Poliuretano.

semiduro (amarillo)

aplicación universal, p. ej. para la construcción de herramientas y máquinas, la reparación de vehículos, los trabajos de chapa y de montaje. Material: Poliuretano.

duro (naranja)

para cargas elevadas, p. ej. para trabajos de montaje y desmontaje, ámbito de la construcción, trabajos en talleres. Material: Acetato de celulosa.

muy duro (blanco)

para una fuerza de impacto elevada, p. ej. para la industria pesada y de la construcción, la construcción de moldes, la construcción de carreteras, la jardinería y el paisajismo. Material: Poliamida.

Podrá encontrar unas instrucciones completas sobre la sustitución visitando la página Web [www.wiha.com/es/es/servicio/descargas/](http://www.wiha.com/es/es/servicio/descargas/)

**Martillo de cara blanda Safety blando/dureza media**



**con mango de madera Hickory, cabezal redondo** 832-13

n° pdo.			mm			€/unid.
26649	30	87	290	289	5	19,63
26650	40	110	325	637	5	25,34
26651	50	131	360	1117	2	34,96
26652	60	150	400	1636	2	44,85

**Martillo de cara blanda Safety de dureza media/semiduro**



**con mango de madera Hickory, cabezal redondo** 832-35

n° pdo.			mm			€/unid.
26434	30	87	290	295	5	20,26
26435	40	110	325	636	5	27,24
26436	50	131	360	1100	2	38,51
26437	60	150	400	1623	2	50,54

**Martillo de cara blanda Safety de dureza media/duro**



**con mango de madera Hickory, cabezal redondo** 832-15

n° pdo.			mm			€/unid.
26653	30	87	290	272	5	20,91
26654	40	110	325	620	5	28,47
26655	50	131	360	1077	2	40,93
26656	60	150	400	1555	2	53,15

**Martillo de cara blanda Safety de dureza media/duro**



**con mango de madera Hickory, cabezal redondo** 832-38

n° pdo.			mm			€/unid.
26611	30	87	290	306	5	19,00
26612	40	110	325	621	5	25,60
26613	50	131	360	1103	2	35,97
26614	60	150	400	1640	2	46,74

**Martillo de cara blanda Safety de dureza media/dureza media**



**con mango de madera Hickory, cabezal redondo** 832-33

n° pdo.			mm			€/unid.
26509	30	87	290	302	5	20,44
26431	40	110	325	640	5	25,24
26432	50	131	360	1130	2	35,53
26433	60	150	400	1692	2	45,68
26439	80	185	490	3136	2	76,68

**Martillo de cara blanda Safety de dureza media/muy duro**



**con mango de madera Hickory, cabezal redondo** 832-39

n° pdo.			mm			€/unid.
26657	30	87	290	314	5	21,15
26658	40	110	325	649	5	27,62
26659	50	131	360	1099	2	40,93
26660	60	150	400	1682	2	54,09
26582	80	185	490	3090	2	88,67
26661	80L•	185	840	3324	2	99,64

•Martillos de fragua

**Cabezal blando**



**redondo para martillo de cara blanda Safety** 831-1

n° pdo.				€/unid.
26663	30	20.5	5	3,99
26664	40	44	5	5,53
26665	50	83.5	2	7,73
26666	60	136	2	10,59

Podrá encontrar unas instrucciones completas sobre la sustitución visitando la página Web [www.wiha.com/es/es/servicio/descargas/](http://www.wiha.com/es/es/servicio/descargas/)

**Martillo de cara blanda Safety semiduro/semiduro**



**con mango de madera Hickory, cabezal redondo** 832-55

n° pdo.			mm			€/unid.
26640	30	87	290	296	5	21,16
26641	40	110	325	609	5	29,97
26642	50	131	360	1120	2	44,34
26643	60	150	400	1638	2	58,43

**Martillo de cara blanda Safety de dureza media/muy duro**



**con mango de madera Hickory, cabezal redondo** 832-99

n° pdo.			mm			€/unid.
26644	30	87	290	299	5	23,05
26645	40	110	325	602	5	31,36
26646	50	131	360	1128	2	49,74
26647	60	150	400	1637	2	63,96
26648	80	185	490	2940	2	103,62
26674	80L•	185	840	3284	2	109,87

•Martillos de fragua

**Cabezal dureza media**



**redondo para martillo de cara blanda Safety** 831-3

n° pdo.				€/unid.
26422	30	30.6	5	3,48
26423	40	78	5	4,68
26424	50	129.5	2	6,30
26425	60	229	2	8,95
26426	80•	479	2	15,60

•también para martillos macho

Podrá encontrar unas instrucciones completas sobre la sustitución visitando la página Web [www.wiha.com/es/es/servicio/descargas/](http://www.wiha.com/es/es/servicio/descargas/)

**Cabezal semiduro**



**redondo para martillo de cara blanda Safety** 831-5

n° pdo.				€/unid.
26427	30	28.2	5	4,43
26428	40	58.5	5	7,18
26429	50	117	2	10,45
26430	60	189	2	15,11

Podrá encontrar unas instrucciones completas sobre la sustitución visitando la página Web [www.wiha.com/es/es/servicio/descargas/](http://www.wiha.com/es/es/servicio/descargas/)

### Cabezal duro



#### redondo para martillo de cara blanda Safety

831-8

n° pdo.				€/unid.
26615	30	25.5	5	3,29
26616	40	53.5	5	5,91
26618	50	98.7	2	8,98
26620	60	182.5	2	12,57

### Juego de carcasas para martillos



#### con tornillo y tuerca de seguridad para martillo de cara blanda Safety

829-0

n° pdo.				€/unid.
26668	30	159	1	9,73
26669	40	375	1	13,96
26670	50	709	1	19,17
26671	60	1017	1	23,55
26672	80•	1894	1	44,27

•también para martillos macho

Podrá encontrar unas instrucciones completas sobre la sustitución visitando la página Web [www.wiha.com/es/es/servicio/descargas/](http://www.wiha.com/es/es/servicio/descargas/)

### Cabezal muy duro



#### redondo para martillo de cara blanda Safety

831-9

n° pdo.				€/unid.
26510	30	26.8	5	5,53
26511	40	57.4	5	8,45
26512	50	112	2	14,33
26513	60	191	2	20,05
26514	80•	395	2	31,37

•también para martillos macho

Podrá encontrar unas instrucciones completas sobre la sustitución visitando la página Web [www.wiha.com/es/es/servicio/descargas/](http://www.wiha.com/es/es/servicio/descargas/)

### Mango de madera Hickory



#### para martillo de cara blanda Safety

830-0

n° pdo.					€/unid.
26417	30	260	93	5	4,97
26418	40	280	119	5	5,38
26419	50	310	190	5	6,64
26420	60	340	202	10	7,29
26421	80	400	302	5	8,69
26667	80	800	601	1	19,03

Podrá encontrar unas instrucciones completas sobre la sustitución visitando la página Web [www.wiha.com/es/es/servicio/descargas/](http://www.wiha.com/es/es/servicio/descargas/)

**Martillo de cara blanda sin contragolpe, muy duro**



**con mango de madera Hickory, cabezal redondo** 8001

n° pdo.			mm			€/unid.
39008	30	115	350	444	5	33,88
39010	40	125	375	750	5	42,70
39012	50	135	385	1040	2	54,03
39014	60	165	420	1700	2	91,92

**Martillo de cara blanda sin contragolpe, muy duro**



**con tubo de acero, cabezal redondo** 8021

n° pdo.			mm			€/unid.
39017	30	115	290	556	5	39,96
39019	40	125	305	792	5	48,06
39021	50	135	365	1276	2	60,75
39022	60	165	375	1868	2	95,36

**Martillo de cara blanda sin contragolpe**



**con mango de madera Hickory, cabezal redondo** 800

n° pdo.			mm			€/unid.
02092	25	108	320	300	5	28,42
02093	30	115	350	436	5	29,73
02094	35	118	355	543	5	32,85
02095	40	125	375	736	5	37,54
02096	45	130	380	848	2	43,17
02097	50	135	385	1085	2	47,85
02098	60	165	420	1710	2	80,59
02099	70	165	430	2256	2	103,50

**Martillo de cara blanda sin contragolpe, semiduro**



**con tubo de acero, cabezal redondo** 802

n° pdo.			mm			€/unid.
02122	25	108	288	461	5	34,09
02123	30	115	290	558	5	36,60
02124	35	118	300	659	5	38,21
02125	40	125	305	791	5	44,56
02126	45	130	310	935	2	50,42
02127	50	135	365	1277	2	56,02
02128	60	165	375	1879	2	88,02
02129	70	165	385	2571	2	132,10

**Martillo de fragua sin contragolpe, semiduro**



**con mango de madera Hickory, cabezal redondo** 800V

n° pdo.			mm			€/unid.
02101	80	205	880	4580	2	202,79
02091	100	210	1000	6880	1	318,32



### Mango de madera Hickory



#### redonda para martillo de cara blanda sin contragolpe

800S

n° pdo.		 mm			€/unid.
02113	25	295	63	10	5,86
02114	30	320	105	10	6,24
02115	40	335	142	10	6,92
02116	50	335	145	10	7,18
02117	60	360	192	5	8,70
28051	80•	800	792	10	21,66
28052	100•	900	1017	1	28,47

•también para martillos macho



Podrá encontrar unas instrucciones completas sobre la sustitución visitando la página Web [www.wiha.com/es/es/servicio/descargas/](http://www.wiha.com/es/es/servicio/descargas/)

### Cabezal muy duro



#### redonda para martillo de cara blanda sin contragolpe

8001K



n° pdo.				€/unid.
39149	30	17.4	10	5,57
39150	40	69	5	6,36
39151	50	67	2	8,21
39152	60	115	1	12,96

### Cabezal semiduro



#### redonda para martillo de cara blanda sin contragolpe

800K

n° pdo.				€/unid.
02103	25	13.17	10	3,42
02104	30	18.4	10	3,79
02105	35	26	10	4,55
02106	40	37.5	10	5,53
02107	45	52.5	5	6,35
02108	50	72	5	7,22
02109	60	119	5	11,71
02110	70	166	5	17,32
02111	80	239	2	23,04
02102	100	394	2	35,35

#### INFOBOX:

#### Martillo de cara blanda sin contragolpe



- Trabajar sin retroceso gracias al relleno de metal especial de la cabeza del martillo.
- La masa un 25 % mayor de la cabeza del martillo ofrece una potencia adicional.
- Protege las superficies de impacto y los bordes sensibles mediante el comportamiento adecuado de impacto.

**Juego de destornilladores-perforadores de agujeros para espigas SoftFinish® con espigas**



con varilla redonda de 6 mm, en blíster, de 5 unid.

SB534S5

n° pdo.	📦	€/unid.
41289	1	27,84

- 1 x Destornillador-perforador de agujeros para espigas
- 2 x Pasador de 30 mm / 2 x Pasador de 40 mm

**Martillo de electricista**



con cabeza del martillo de 300 g, en blíster

846

n° pdo.	📏	mm	🔩	📦	€/unid.
42071	23.9	283	500	4	36,34

**INFOBOX:**

**Juego de destornilladores-perforadores de agujeros para espigas SoftFinish® con espigas**

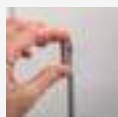

- Facilita la inserción de espigas y ahorra un tiempo de trabajo valioso.
- Permite trabajar sin suciedad y sin polvo en comparación con el uso de máquinas.
- La separación galvánica entre la varilla y la plancha de acero protege con posibles descargas eléctricas.
- Es perfecto para el uso móvil, ya que es posible realizar un agujero para espigas en cualquier momento y en cualquier lugar mediante un simple golpe con el martillo.

**INFOBOX:**

**Martillo de electricista**



- La distribución del peso equilibrada de forma óptima garantiza un balance perfecto para golpear y para realizar un trabajo sin fatigas.
- Las orejas planas del martillo facilitan la retirada de elementos de fijación como abrazaderas de clavos, incluso en lugares de difícil acceso.
- Gracias a la superficie de impacto en forma de U, permite una accesibilidad óptima a los espacios estrechos y a las esquinas.
- La base plana del mango del martillo sirve como martillo de cara blanda para la colocación sin ocasionar daños, p. ej. de cables y espigas.

## Nivel de burbuja de aire para electricistas



40 cm

246

n° pdo.	mm			€/unid.
42074	400	330	1	40,45

### INFOBOX:

#### Nivel de burbuja de aire para electricistas de 40 cm



- Permite marcar de forma sencilla y rápida hasta cuatro cajas empotrables en una sola operación gracias a los puntos de marcado integrados.
- La carcasa continua permite marcar líneas sin interrupciones.
- Incluso visto desde arriba, se puede realizar una medición precisa con la ayuda de una escala adicional colocada en la parte superior.
- Incluso en ángulos agudos se pueden leer perfectamente los niveles de burbuja.
- Gracias a la forma compacta se adapta perfectamente para el uso móvil.

**Pie de rey digiMax® digital**



con lectura de 0,01 mm

4111

n° pdo.					€/unid.
29422	150	6"	139	5	101,51

**Metro plegable para electricista Longlife 2 m**



métrico, de 10 eslabones

4102008

n° pdo.					€/unid.
42068	15	naranja	135	10	14,29

**Pie de rey caliMax®**



con lectura de 0,1 mm

4113

n° pdo.					€/unid.
27083	150	6"	74	10	35,98

**Metro plegable LongLife® Plus Composite de 2 m**



métrico, de 10 eslabones

4102005

n° pdo.					€/unid.
37067	15	roja / negra	124	10	13,75

**Pie de rey con reloj dialMax®**



con lectura de 0,1 mm

4112

n° pdo.					€/unid.
27082	150	6"	104	1	45,87

**Pie de rey con reloj dialMax® ESD**



con lectura de 0,1 mm

4112

n° pdo.					€/unid.
31439	150	6"	96	1	61,30

**INFOBOX:  
Metro plegable  
LongLife® Plus  
Composite**



- La rigidez elevada minimiza el riesgo de rotura.
- Enclavamiento de 90° y de 180° rígido de todas las articulaciones.
- Extremos de metal imperdibles en el eslabón inicial y en el final.
- Lectura por ambos lados gracias a la escala recto verso.

### Metro plegable Longlife® All in One de 2 m



#### métrico, de 10 eslabones

4102007

n° pdo.					€/unid.
33232	15	blanca	139	10	14,52

### Metro plegable LongLife® Plus de 2 m



#### métrico, de 10 eslabones

4102001

n° pdo.					€/unid.
27055	15	amarilla	136	10	12,86
27059	15	blanca	136	10	12,86

### Metro plegable Longlife® de 2 m



#### métrico, de 10 eslabones

4102000

n° pdo.					€/unid.
27058	15	amarilla	137	10	10,86
27057	15	blanca	136	10	10,86

### Metro plegable Longlife® de 1 m



#### métrico, de 10 eslabones

4101000

n° pdo.					€/unid.
27061	13	amarilla	43	10	8,35
27062	13	blanca	43	10	8,35

### Cinta métrica 5 m



#### con clip para el cinturón

n° pdo.					€/unid.
33251	70	80	5000 x 19	1	10,94



### **Accesorios electrotécnicos Para una conexión segura.**

Precisamente en la conexión de cables de alambre fino en bornes, los electricistas tienen que tener cuidado de que los alambres individuales no se aplasten ni queden sueltos. De lo contrario pueden producirse roturas de cable o cortocircuitos, que representan una causa potencial de incendios. Los extremos del cable pueden evitar esta situación y se encargan de ofrecer una seguridad de contacto y, con ello, un funcionamiento seguro. El cuello cónico facilita la inserción del torón en el casquillo durante la instalación. Con el casquillo también se simplifica la inserción del cable en el borne. Los extremos de cable gemelos están especialmente diseñados para la conexión de dos cables. Los extremos de cable sin halógenos de Wiha tienen una resistencia térmica de hasta 105 °C.

Ideal para la conexión de cables de alambre fino, especialmente en conexiones de borne.

Con herramienta para cortar a medida, desaislar y pelar cables entre 0,03 y 16 mm<sup>2</sup>.

Para aplicaciones en la electricidad

Herramienta pelacables y crimpadora, juego de 4 unid. con elementos de unión 2600 ud. codificación por colores DIN en caja surtida  
Página 336



Juego de cajas insertables de 16 unid., para caja para herramientas surtidas, con elementos de fijación  
Página 337



Herramienta pelacables y crimpadora, juego de 5 unid. con extremos de cable 500 ud. codificación por colores DIN en L-Boxx Mini  
Página 337



Expositor de extremos de cable Código de color DIN, 0,5 - 10 mm<sup>2</sup> en bolsa y 0,5 - 16 mm<sup>2</sup> en caja expendedora  
Página 338



Extremo del cable con cuello de plástico, juego 0,5 - 2,5 mm<sup>2</sup> 400 ud. codificación por colores DIN en bote distribuidor  
Página 339

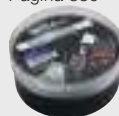

Extremo del cable gemelo con cuello de plástico, juego 2 x 0,75 - 2 x 2,50 mm<sup>2</sup> 200 ud. codificación por colores DIN en bote distribuidor  
Página 339



Extremo del cable con cuello de plástico, juego 100 ud. codificación por colores 1 (FR) / DIN  
Página 340



Extremo del cable gemelo con cuello de plástico 100 ud. codificación por colores 1 (FR) & DIN  
Página 342



Terminal de cable plano forma anular aislado 100 ud. según DIN  
Página 344



Terminal de cable plano forma de horquilla aislado 100 ud. según DIN  
Página 344



Conector de choque aislado 100 ud. según DIN  
Página 345



Casquillo de enchufe plano aislado 100 ud. según DIN  
Página 345



Casquillo de enchufe plano completamente aislado 100 ud. según DIN  
Página 346



Enchufe plano aislado 100 ud. según DIN  
Página 346

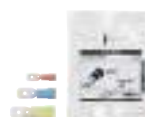

Herramienta pelacables y crimpadora, juego de 4 unid.



con elementos de unión 2600 ud. codificación por colores DIN en caja surtida

93001013

n° pdo.		€/unid.
43984		1 636,05
●	1 x Crimpadora automática para extremos de cables, con presión hexagonal	
	1 x Herramienta pelacable automática hasta 16 mm <sup>2</sup> en blíster	
●	1 x Crimpadoras para terminales de cables y contactos aislados	
🔌	400 x 0.5 mm <sup>2</sup> / 400 x 0.75 mm <sup>2</sup> / 400 x 1 mm <sup>2</sup> / 300 x 1.5 mm <sup>2</sup> / 200 x 2.5 mm <sup>2</sup> / 100 x 4 mm <sup>2</sup> / 50 x 6 mm <sup>2</sup> / 50 x 10 mm <sup>2</sup> / 50 x 16 mm <sup>2</sup>	
🔌	50 x 0.5 - 1; M4 / 50 x 0.5 - 1; M5 / 50 x 1.5 - 2.5; M5 / 50 x 1.5 - 2.5; M6 / 50 x 4 - 6; M6 / 50 x 4 - 6; M8	
🔌	50 x 0.5 - 1 mm <sup>2</sup> / 50 x 1.5 - 2.5 mm <sup>2</sup> / 50 x 4 - 6 mm <sup>2</sup>	
🔌	50 x 0.5 - 1 mm <sup>2</sup> / 50 x 1.5 - 2.5 mm <sup>2</sup>	
🔌	50 x 0.5 - 1 mm <sup>2</sup> / 50 x 1.5 - 2.5 mm <sup>2</sup>	
	1 x Caja	

con elementos de unión 2600 ud. codificación por colores 1 (FR) en caja surtida

93001011

n° pdo.		€/unid.
43982		1 636,05
●	1 x Crimpadora automática para extremos de cables, con presión hexagonal	
	1 x Herramienta pelacable automática hasta 16 mm <sup>2</sup> en blíster	
●	1 x Crimpadoras para terminales de cables y contactos aislados	
🔌	400 x 0.5 mm <sup>2</sup> / 400 x 0.75 mm <sup>2</sup> / 400 x 1 mm <sup>2</sup> / 300 x 1.5 mm <sup>2</sup> / 200 x 2.5 mm <sup>2</sup> / 100 x 4 mm <sup>2</sup> / 50 x 6 mm <sup>2</sup> / 50 x 10 mm <sup>2</sup> / 50 x 16 mm <sup>2</sup>	
🔌	50 x 0.5 - 1; M4 / 50 x 0.5 - 1; M5 / 50 x 1.5 - 2.5; M5 / 50 x 1.5 - 2.5; M6 / 50 x 4 - 6; M6 / 50 x 4 - 6; M8	
🔌	50 x 0.5 - 1 mm <sup>2</sup> / 50 x 1.5 - 2.5 mm <sup>2</sup> / 50 x 4 - 6 mm <sup>2</sup>	
🔌	50 x 0.5 - 1 mm <sup>2</sup> / 50 x 1.5 - 2.5 mm <sup>2</sup>	
🔌	50 x 0.5 - 1 mm <sup>2</sup> / 50 x 1.5 - 2.5 mm <sup>2</sup>	
	1 x Caja	



## Juego de cajas insertables



de 16 unid., para caja para herramientas surtidas, con elementos de fijación

93001911R

n° pdo.



€/unid.

43995

1

23,27

8 x Caja surtida, pequeña

8 x Caja surtida, grande

Recambio: Cajas de inserción para la caja de surtido de elementos de conexión 43982 y 43984

## Herramienta pelacables y crimpadora, juego de 5 unid.



con extremos de cable 500 ud. codificación por colores DIN en L-Boxx Mini

93001003

n° pdo.



€/unid.

43987

1

395,87

### Desaislar / pelar / crimpar

● 1 x Crimpadora automática para extremos de cables, con presión hexagonal

1 x Herramienta pelacable automática hasta 16 mm<sup>2</sup> en blíster

Extremo del cable con cuello de plástico, juego 0,5 - 2,5 mm<sup>2</sup> 400 ud. codificación por colores DIN en bote distribuidor (43904)  
50 x 0,5 mm<sup>2</sup> / 100 x 0,75 mm<sup>2</sup> / 100 x 1 mm<sup>2</sup> / 100 x 1,5 mm<sup>2</sup> / 50 x 2,5 mm<sup>2</sup>

Extremo del cable con cuello de plástico, juego 4 - 16 mm<sup>2</sup> 100 ud. codificación por colores DIN en bote distribuidor (43903)  
50 x 4 mm<sup>2</sup> / 20 x 6 mm<sup>2</sup> / 20 x 10 mm<sup>2</sup> / 10 x 16 mm<sup>2</sup>

### Almacenamiento

1 x L-Boxx Mini

con extremos de cable 500 ud. codificación por colores 1 (FR) en L-Boxx Mini

93001001

n° pdo.



€/unid.

43985

1

395,87

### Desaislar / pelar / crimpar

● 1 x Crimpadora automática para extremos de cables, con presión hexagonal

1 x Herramienta pelacable automática hasta 16 mm<sup>2</sup> en blíster

Extremo del cable con cuello de plástico, juego 0,5 - 2,5 mm<sup>2</sup> 400 ud. codificación por colores 1 (FR) en bote distribuidor (43900)  
50 x 0,5 mm<sup>2</sup> / 100 x 0,75 mm<sup>2</sup> / 100 x 1 mm<sup>2</sup> / 100 x 1,5 mm<sup>2</sup> / 50 x 2,5 mm<sup>2</sup>

Extremo del cable con cuello de plástico, juego 4 - 16 mm<sup>2</sup> 100 ud. codificación por colores 1 (FR) en bote distribuidor (43899)  
50 x 4 mm<sup>2</sup> / 20 x 6 mm<sup>2</sup> / 20 x 10 mm<sup>2</sup> / 10 x 16 mm<sup>2</sup>

### Almacenamiento

1 x L-Boxx Mini





**Código de color DIN, 0,5 - 10 mm<sup>2</sup> en bolsa y 0,5 - 16 mm<sup>2</sup> en caja expendedora**

C000CVH

n° pdo.	€/unid.
44007	1 1682,25
8 x Extremo del cable con cuello de plástico, juego 0,5 - 2,5 mm <sup>2</sup> 400 ud. codificación por colores DIN en bote distribuidor (43904) 50 x 0,5 mm <sup>2</sup> / 100 x 0,75 mm <sup>2</sup> / 100 x 1 mm <sup>2</sup> / 100 x 1,5 mm <sup>2</sup> / 50 x 2,5 mm <sup>2</sup>	
8 x Extremo del cable con cuello de plástico, juego 4 - 16 mm <sup>2</sup> 100 ud. codificación por colores DIN en bote distribuidor (43903) 50 x 4 mm <sup>2</sup> / 20 x 6 mm <sup>2</sup> / 20 x 10 mm <sup>2</sup> / 10 x 16 mm <sup>2</sup>	
80 x 0.5 mm <sup>2</sup> / 80 x 0.75 mm <sup>2</sup> / 60 x 1 mm <sup>2</sup> / 60 x 1.5 mm <sup>2</sup> / 50 x 2.5 mm <sup>2</sup> / 30 x 4 mm <sup>2</sup> / 20 x 6 mm <sup>2</sup> / 20 x 10 mm <sup>2</sup>	

**Código de color 1 (FR), 0,5 - 10 mm<sup>2</sup> en bolsa y 0,5 - 16 mm<sup>2</sup> en caja expendedora**

C000AVH

n° pdo.	€/unid.
44005	1 1682,25
8 x Extremo del cable con cuello de plástico, juego 0,5 - 2,5 mm <sup>2</sup> 400 ud. codificación por colores 1 (FR) en bote distribuidor (43900) 50 x 0,5 mm <sup>2</sup> / 100 x 0,75 mm <sup>2</sup> / 100 x 1 mm <sup>2</sup> / 100 x 1,5 mm <sup>2</sup> / 50 x 2,5 mm <sup>2</sup>	
8 x Extremo del cable con cuello de plástico, juego 4 - 16 mm <sup>2</sup> 100 ud. codificación por colores 1 (FR) en bote distribuidor (43899) 50 x 4 mm <sup>2</sup> / 20 x 6 mm <sup>2</sup> / 20 x 10 mm <sup>2</sup> / 10 x 16 mm <sup>2</sup>	
80 x 0.5 mm <sup>2</sup> / 80 x 0.75 mm <sup>2</sup> / 60 x 1 mm <sup>2</sup> / 60 x 1.5 mm <sup>2</sup> / 50 x 2.5 mm <sup>2</sup> / 30 x 4 mm <sup>2</sup> / 20 x 6 mm <sup>2</sup> / 20 x 10 mm <sup>2</sup>	

**Extremo del cable con cuello de plástico, juego**



**0,5 - 2,5 mm<sup>2</sup> 400 ud. codificación por colores DIN en bote distribuidor**

C000C400

n° pdo.		€/unid.
43904	8	27,12

50 x 0.5 mm<sup>2</sup> / 100 x 0.75 mm<sup>2</sup> / 100 x 1 mm<sup>2</sup> / 100 x 1.5 mm<sup>2</sup> / 50 x 2.5 mm<sup>2</sup>

**0,5 - 2,5 mm<sup>2</sup> 400 ud. codificación por colores 1 (FR) en bote distribuidor**

C000A400

n° pdo.		€/unid.
43900	8	27,12

50 x 0.5 mm<sup>2</sup> / 100 x 0.75 mm<sup>2</sup> / 100 x 1 mm<sup>2</sup> / 100 x 1.5 mm<sup>2</sup> / 50 x 2.5 mm<sup>2</sup>

**4 - 16 mm<sup>2</sup> 100 ud. codificación por colores DIN en bote distribuidor**

C000C100

n° pdo.		€/unid.
43903	8	27,12

50 x 4 mm<sup>2</sup> / 20 x 6 mm<sup>2</sup> / 20 x 10 mm<sup>2</sup> / 10 x 16 mm<sup>2</sup>

**4 - 16 mm<sup>2</sup> 100 ud. codificación por colores 1 (FR) en bote distribuidor**

C000A100

n° pdo.		€/unid.
43899	8	27,12

50 x 4 mm<sup>2</sup> / 20 x 6 mm<sup>2</sup> / 20 x 10 mm<sup>2</sup> / 10 x 16 mm<sup>2</sup>

**Extremo del cable gemelo con cuello de plástico, juego**



**2 x 0,75 - 2 x 2,50 mm<sup>2</sup> 200 ud. codificación por colores DIN en bote distribuidor**

C001C200

n° pdo.		€/unid.
43907	8	27,12

50 x 2 x 0.75 / 50 x 2 x 1 / 50 x 2 x 1.5 / 50 x 2 x 2.5

**2 x 0,75 - 2 x 2,50 mm<sup>2</sup> 200 ud. codificación por colores 1 (FR) en bote distribuidor**

C001A200

n° pdo.		€/unid.
43905	8	27,12

50 x 2 x 0.75 / 50 x 2 x 1 / 50 x 2 x 1.5 / 50 x 2 x 2.5



Extremo del cable con cuello de plástico, juego

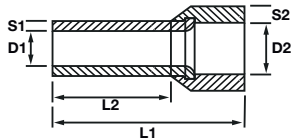

100 ud. codificación por colores 1 (FR) / DIN

C000A

n° pdo.		mm <sup>2</sup>	AWG	D1	D2	L1	L2	S1	S2	↓↑		€/unid.
43911	blanca	0.5	20	1	2.6	14	8	0.15	0.25	100	40	2,54
43996	gris	0.75	18	1.2	2.8	14	8	0.15	0.25	100	40	2,54
43913	roja	1	18	1.4	3	14	8	0.15	0.25	100	60	2,44
43914	negra	1.5	16	1.7	3.5	14	8	0.15	0.25	100	60	2,44
43927	azul	2.5	14	2.2	4.2	14	8	0.15	0.25	100	50	2,96
43928	gris	4	12	2.8	4.8	17	10	0.2	0.3	100	30	4,91
43932	amarilla	6	10	3.5	6.3	20	12	0.2	0.3	100	20	7,59
43933	roja	10	8	4.5	7.6	22	12	0.2	0.4	50	20	5,13
43934	azul	16	6	5.8	8.8	24	12	0.2	0.4	50	20	7,19

















100 ud. codificación por colores 1 (FR)

C000A

n° pdo.		mm <sup>2</sup>	AWG	D1	D2	L1	L2	S1	S2	↓↑		€/unid.
43908	marrón•	0.14	26	0.7	1.6	12	6	0.15	0.25	100	40	3,23
43909	púrpura•	0.25	24	0.75	1.8	12	6	0.15	0.25	100	40	3,23
43910	rosa clarodo•	0.34	22	0.8	2	12	6	0.15	0.25	100	40	3,23
43911	blanca	0.5	20	1	2.6	14	8	0.15	0.25	100	40	2,54
43912	azul	0.75	18	1.2	2.8	14	8	0.15	0.25	100	40	2,54
43913	roja	1	18	1.4	3	14	8	0.15	0.25	100	60	2,44
43914	negra	1.5	16	1.7	3.5	14	8	0.15	0.25	100	60	2,44
43915	gris	2.5	14	2.2	4.2	14	8	0.15	0.25	100	50	2,96
43916	naranja	4	12	2.8	4.8	17	10	0.2	0.3	100	30	4,91
43917	verde	6	10	3.5	6.3	20	12	0.2	0.3	100	20	7,59
43918	marrón	10	8	4.5	7.6	22	12	0.2	0.4	50	20	5,13
43919	marfil	16	6	5.8	8.8	24	12	0.2	0.4	50	20	7,19

•Tamaño adicional a las dimensiones DIN

CUADRO INFORMATIVO:  
**Extremo del cable con  
 cuello de plástico**

mm <sup>2</sup>	mm	↓	⌘	Codificación por colores DIN		Codificación por colores 1 (FR)	
					N° pdo.		N° pdo.
0,14	6	100	40			 marrón•	43908
0,25	6	100	40			 lila•	43909
0,34	6	100	40			 rosa claro•	43910
0,50	8	100	40		blanco 43911		blanco 43911
0,75	8	100	40		gris 43996		azul 43912
1,00	8	100	60		rojo 43913		rojo 43913
1,50	8	100	60		negro 43914		negro 43914
2,50	8	100	50		azul 43927		gris 43915
4,00	10	100	30		gris 43928		naranja 43916
6,00	12	100	20		amarillo 43932		verde 73917
10,00	12	50	20		rojo 43933		marrón 43918
16,00	12	50	20		azul 43934		marfil 43919

• Tamaño complementario a las dimensiones DIN



Extremo del cable gemelo con cuello de plástico

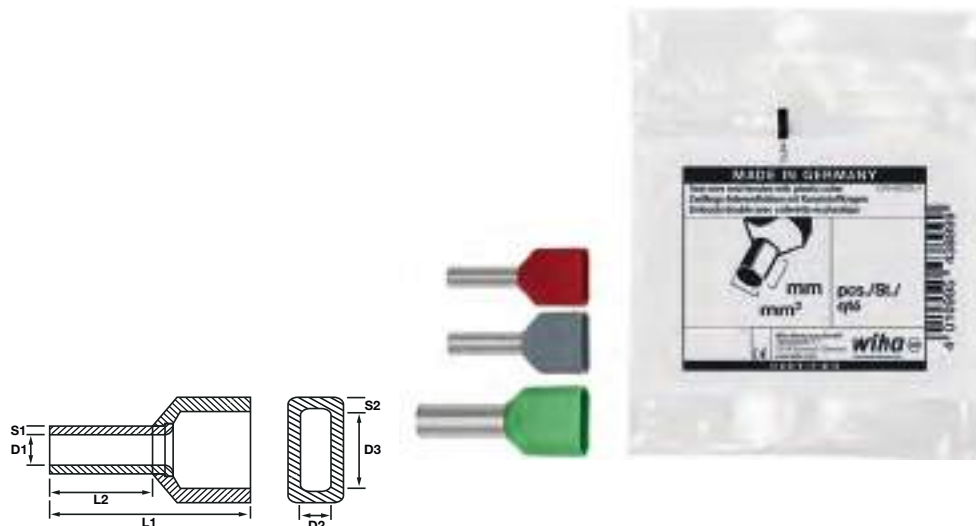

100 ud. codificación por colores 1 (FR) & DIN

C001A

n° pdo.		mm <sup>2</sup>	AWG	D1	D2	D3	L1	L2	S1	S2	↓		€/unid.
43935	blanca	2 x 0.5	2 x 20	1.4	2.5	4.7	15	8	0.15	0.25	100	30	4,25
43951	gris	2 x 0.75	2 x 18	1.7	2.8	5	15	8	0.15	0.25	100	20	4,52
43937	roja	2 x 1	2 x 18	1.95	3.4	5.4	15	8	0.15	0.3	100	20	5,00
43938	negra	2 x 1.5	2 x 16	2.2	3.6	6.6	16	8	0.15	0.3	100	30	5,03
43947	azul	2 x 2.5	2 x 14	2.8	4.2	7.8	18.5	10	0.2	0.3	100	20	6,96
43948	gris	2 x 4	2 x 12	3.7	4.9	8.8	23	12	0.2	0.4	50	20	6,99
43952	amarilla	2 x 6	2 x 10	4.8	6.9	10	26	14	0.2	0.4	50	15	9,89
43953	roja	2 x 10	2 x 8	6.4	7.2	13	26	14	0.2	0.4	25	20	8,00

100 ud. codificación por colores 1 (FR) & DIN

C001A

n° pdo.		mm <sup>2</sup>	AWG	D1	D2	D3	L1	L2	S1	S2	↓		€/unid.
43935	blanca	2 x 0.5	2 x 20	1.4	2.5	4.7	15	8	0.15	0.25	100	30	4,25
43936	azul	2 x 0.75	2 x 18	1.7	2.8	5	15	8	0.15	0.25	100	20	4,52
43937	roja	2 x 1	2 x 18	1.95	3.4	5.4	15	8	0.15	0.3	100	20	5,00
43938	negra	2 x 1.5	2 x 16	2.2	3.6	6.6	16	8	0.15	0.3	100	30	5,03
43939	gris	2 x 2.5	2 x 14	2.8	4.2	7.8	18.5	10	0.2	0.3	100	20	6,96
43940	naranja	2 x 4	2 x 12	3.7	4.9	8.8	23	12	0.2	0.4	50	20	6,99
43941	verde	2 x 6	2 x 10	4.8	6.9	10	26	14	0.2	0.4	50	15	9,89
43942	marrón	2 x 10	2 x 8	6.4	7.2	13	26	14	0.2	0.4	25	20	8,00

CUADRO INFORMATIVO:  
**Extremo del cable  
gemelo con cuello de  
plástico**

mm <sup>2</sup>	mm	↓	⏏	Codificación por colores DIN		Codificación por colores 1 (FR)	
					N° pdo.		N° pdo.
2 x 0,50	8	100	30	 blanco	43935	 blanco	43935
2 x 0,75	8	100	20	 gris	43951	 azul	43936
2 x 1,00	8	100	20	 rojo	43937	 rojo	43937
2 x 1,50	8	100	30	 negro	43938	 negro	43938
2 x 2,50	10	100	20	 azul	43947	 gris	43939
2 x 4,00	12	50	20	 gris	43948	 naranja	43940
2 x 6,00	14	50	15	 amarillo	43952	 verde	43941
2 x 10,00	14	25	20	 rojo	43953	 marrón	43942



## Terminal de cable plano forma anular aislado

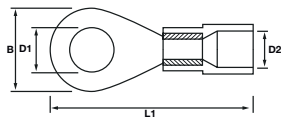

### 100 ud. según DIN

C020

n° pdo.		mm <sup>2</sup>	AWG		D1	D2	L1	B			€/unid.
43954	roja	0.5 - 1 mm <sup>2</sup>	22 - 16	M4	4.1	4.3	18	8	100	15	13,34
43956	roja	0.5 - 1 mm <sup>2</sup>	22 - 16	M5	4.1	5.3	19	10	100	15	13,84
43958	roja	0.5 - 1 mm <sup>2</sup>	22 - 16	M6	4.1	6.5	21	11	100	15	15,99
43955	azul	1.5 - 2.5 mm <sup>2</sup>	16 - 14	M4	4.5	4.3	18	8	100	15	13,71
43957	azul	1.5 - 2.5 mm <sup>2</sup>	16 - 14	M5	4.5	5.3	20	10	100	15	14,57
43959	azul	1.5 - 2.5 mm <sup>2</sup>	16 - 14	M6	4.5	6.5	22	11	100	15	17,26
43960	amarilla	4 - 6 mm <sup>2</sup>	12 - 10	M6	6.5	6.5	23	11	50	15	23,50
43961	amarilla	4 - 6 mm <sup>2</sup>	12 - 10	M8	6.5	8.4	26	14	50	15	26,12

## Terminal de cable plano forma de horquilla aislado

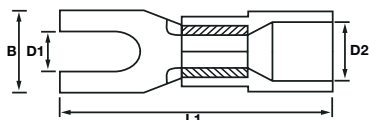

### 100 ud. según DIN

C040

n° pdo.		mm <sup>2</sup>	AWG		D1	D2	L1	B			€/unid.
43962	roja	0.5 - 1 mm <sup>2</sup>	22 - 16	M4	4.1	4.3	18	8	100	15	14,27
43963	azul	1.5 - 2.5 mm <sup>2</sup>	16 - 14	M4	4.5	4.3	18	8	100	15	14,32
43964	amarilla	4 - 6 mm <sup>2</sup>	12 - 10	M5	6.5	5.3	22	10	50	15	22,89



## Conector de choque aislado

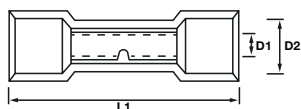

### 100 ud. según DIN

C101

n° pdo.		mm <sup>2</sup>	AWG	D1	D2	L1	↓		€/unid.
43965	roja	0.5 - 1 mm <sup>2</sup>	22 - 16	4.1	1.6	26	100	15	16,17
43966	azul	1.5 - 2.5 mm <sup>2</sup>	16 - 14	4.5	2.3	26	100	15	17,89
43967	amarilla	4 - 6 mm <sup>2</sup>	12 - 10	6.5	3.6	28	50	15	26,06

## Casquillo de enchufe plano aislado

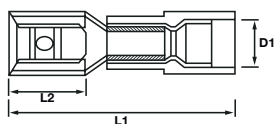

### 100 ud. según DIN

C141

n° pdo.		mm <sup>2</sup>	AWG		D1	L1	L2	↓		€/unid.
43968	roja	0.5 - 1 mm <sup>2</sup>	22 - 16	6.3 x 0.8 mm	3.5	21	7.8	100	15	17,21
43969	azul	1.5 - 2.5 mm <sup>2</sup>	16 - 14	6.3 x 0.8 mm	4.3	21	7.8	100	15	17,82
43970	amarilla	4 - 6 mm <sup>2</sup>	12 - 10	6.3 x 0.8 mm	6.2	23.8	7.8	50	15	25,52



## Casquillo de enchufe plano completamente aislado

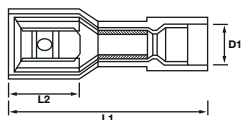

### 100 ud. según DIN

C146

n° pdo.		mm <sup>2</sup>	AWG		D1	L1	L2	↓		€/unid.
43971	roja	0.5 - 1 mm <sup>2</sup>	22 - 16	6.3 x 0.8 mm	3.5	21.5	6.8	100	15	20,33
43972	azul	1.5 - 2.5 mm <sup>2</sup>	16 - 14	6.3 x 0.8 mm	4.3	21.8	6.8	100	15	21,12
43973	amarilla	4 - 6 mm <sup>2</sup>	12 - 10	6.3 x 0.8 mm	5.8	25	6.8	50	15	25,81

## Enchufe plano aislado

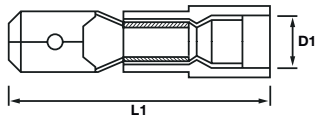

### 100 ud. según DIN

C161

n° pdo.		mm <sup>2</sup>	AWG		D1	L1	↓		€/unid.
43974	roja	0.5 - 1 mm <sup>2</sup>	22 - 16	6.3 x 0.8 mm	3.5	21.5	100	15	14,81
43975	azul	1.5 - 2.5 mm <sup>2</sup>	16 - 14	6.3 x 0.8 mm	4.3	21.3	100	15	15,92
43976	amarilla	4 - 6 mm <sup>2</sup>	12 - 10	6.3 x 0.8 mm	6.2	24	50	15	23,12



# ¿En qué página puedo encontrar mi producto?

## Destornilladores, herramientas dinamométricas

### Destornilladores











	Ranurado	Phillips PH	Xeno SL/PH	Pozidriv PZ	Xeno SL/PZ	TORX®	TORX® Tamper Resistant	TORX PLUS®
Destornillador SoftFinish®	•	•		•		•	•	•
Destornillador SoftFinish® con función de sujeción	•	•						
Destornillador SoftFinish® con escala en mm	•	•		•				
Destornillador SoftFinish® Stubby	•	•		•				
Destornillador MicroFinish	•	•		•		•		
Destornillador pequeño	•							
Destornillador de precisión PicoFinish®	•	•		•		•		•
Destornillador SoftFinish® electric slimFix	•	•	•	•	•	•	•	
Destornillador SoftFinish® electric	•	•	•	•	•	•		
Bit slimBit electric	•	•	•	•	•	•		
Destornillador de precisión PicoFinish® electric	•	•						
Comprobador de tensión	•							
Destornillador SoftFinish® ESD	•	•		•		•		
Destornillador de precisión PicoFinish® ESD	•	•		•		•		•













### Herramientas dinamométricas



	Ranurado	Phillips PH	Xeno SL/PH	Pozidriv PZ	Xeno SL/PZ	TORX®	TORX® Tamper Resistant	TORX PLUS®
Destornillador dinamométrico de ajuste variable	•	•		•		•		•
Destornillador dinamométrico preajustado de forma fija	•	•		•		•		•
Destornillador dinamométrico electric	•	•	•	•	•	•		
Bit slimBit electric	•	•	•	•	•	•		
Destornillador dinamométrico con mango corredizo						•		•
Destornillador dinamométrico con mango de llave TorqueFix®						•		•

												
Hexagonal interior	Hexágono exterior	Cuadrado interior	Cuadrado exterior	Hexagonal interior con taladro (Tamper Resistant)	Triángulo exterior	Multi-dientes	Tri-Wing®	Torq-Set®	SIT	Spanner	Pentalobe PL	Y-Type

•	•				•							
	•											
•	•										•	•
•	•	•										
•	•	•										
•	•	•										
•	•											

												
Hexagonal interior	Hexágono exterior	Cuadrado interior	Cuadrado exterior	Hexagonal interior con taladro (Tamper Resistant)	Triángulo exterior	Multi-dientes	Tri-Wing®	Torq-Set®	SIT	Spanner	Pentalobe PL	Y-Type

•	•											
•	•											
•		•										
•		•										
•												
•												
•												

# ¿En qué página puedo encontrar mi producto?

## Herramientas multiusos, llaves Allen, bits

### Herramientas multiusos







							
Ranurado	Phillips PH	Xeno SL/PH	Pozidriv PZ	Xeno SL/PZ	TORX®	TORX® Tamper Resistant	TORX PLUS®

Destornillador con cargador LiftUp electric	•	•		•	•	•	
Destornillador con cargador 26one®	•	•		•	•	•	
Destornillador con cargador LiftUp 25 + 70	•	•		•	•	•	
Destornillador con cargador	•	•		•	•	•	
Destornillador con cargador Stubby	•	•		•	•	•	
Llave Allen herramienta multiusos PocketStar	•	•				•	•
Destornillador con varilla intercambiable SYSTEM 6	•	•		•	•	•	
Destornillador con varilla intercambiable SYSTEM 4	•	•		•	•	•	

### Llave Allen



							
Ranurado	Phillips PH	Xeno SL/PH	Pozidriv PZ	Xeno SL/PZ	TORX®	TORX® Tamper Resistant	TORX PLUS®

Llave Allen					•	•	•
Juego de llaves Allen en soporte ErgoStar					•		
Juego de llaves Allen en soporte ProStar					•		
Juego de llaves Allen en soporte Compact							
Juego de llaves Allen en soporte Classic					•	•	•
Llave Allen con mango corredizo Comfort grip					•		
Llave Allen con mango corredizo Classic					•		•
Llave Allen con mango corredizo electric							
Llave Allen con mango de llave					•		•
Llave Allen con mango de bandera					•		•

### Bits















							
Ranurado	Phillips PH	Xeno SL/PH	Pozidriv PZ	Xeno SL/PZ	TORX®	TORX® Tamper Resistant	TORX PLUS®











TY-Bit		•		•	•		
T-Bit		•		•	•		
Y-Bit		•		•	•		
Bit Professional	•	•		•	•	•	•
Bits con MagicRing®	•	•	•	•	•	•	•
Bit con rosca							
Bit Standard forma C4		•		•	•		
Ranurado	•	•			•		

												
Hexagonal interior	Hexágono exterior	Cuadrado interior	Cuadrado exterior	Hexagonal interior con taladro (Tamper Resistant)	Triángulo exterior	Multi-dientes	Tri-Wing®	Torq-Set®	SIT	Spanner	Pentalobe PL	Y-Type

•		•										
•												
•												
•	•						•	•				
•	•											
•	•											

												
Hexagonal interior	Hexágono exterior	Cuadrado interior	Cuadrado exterior	Hexagonal interior con taladro (Tamper Resistant)	Triángulo exterior	Multi-dientes	Tri-Wing®	Torq-Set®	SIT	Spanner	Pentalobe PL	Y-Type

•												
•												
•												
•												
•												
•												
•	•											
•	•											
•			•									
•												

												
Hexagonal interior	Hexágono exterior	Cuadrado interior	Cuadrado exterior	Hexagonal interior con taladro (Tamper Resistant)	Triángulo exterior	Multi-dientes	Tri-Wing®	Torq-Set®	SIT	Spanner	Pentalobe PL	Y-Type

•												
•		•										
•		•		•		•	•	•	•	•		
•		•						•				
•		•						•				
•												
•	•										•	

# Registro de números de referencia

n° pdo.	Página	n° pdo.	Página	n° pdo.	Página	n° pdo.	Página
<b>00</b>		00706	147	00857	142	00975	226
00456	142	00707	147	00858	142	00977	226
00576	203	00708	147	00859	142	00978	226
00577	203	00709	147	00860	142	00980	226
00578	203	00711	147	00861	142	00982	226
00579	203	00712	147	00862	142	00983	226
00580	203	00713	147	00863	142	00985	226
00582	203	00731	152	00864	142	00986	226
00583	203	00732	152	00865	142	00988	226
00584	203	00733	152	00866	142	00989	226
00585	203	00734	152	00867	142	00990	226
00586	203	00735	152	00868	142	00991	226
00587	203	00736	152	00877	141	00993	226
00597	203	00737	152	00878	141	00994	226
00598	203	00738	152	00879	141	00995	226
00599	203	00739	152	00880	141	<b>01</b>	
00600	203	00740	152	00881	141	01005	226
00601	203	00754	147	00882	141	01006	226
00602	203	00756	147	00894	228	01007	226
00603	203	00757	147	00895	228	01008	226
00610	200	00759	147	00896	228	01018	149
00613	200	00760	147	00897	228	01020	149
00616	200	00762	147	00904	225	01021	149
00623	195	00763	147	00905	225	01022	149
00629	198	00764	152	00906	225	01023	149
00630	198	00765	152	00907	225	01024	149
00631	198	00766	152	00908	225	01025	149
00632	198	00767	152	00909	225	01026	149
00635	198	00768	147	00910	225	01027	149
00636	198	00770	147	00911	225	01028	149
00637	198	00772	147	00912	225	01029	149
00638	198	00774	147	00913	225	01030	149
00639	198	00776	152	00914	225	01031	149
00654	198	00777	152	00915	225	01032	149
00655	198	00778	152	00916	225	01033	149
00656	198	00779	152	00917	225	01034	144
00657	198	00819	141	00918	225	01076	149
00658	198	00820	141	00919	225	01077	149
00665	198	00821	141	00921	225	01078	149
00666	198	00822	141	00922	225	01079	149
00679	154	00823	141	00923	225	01081	149
00683	154	00824	141	00924	225	01092	150
00684	147	00825	141	00926	225	01093	150
00685	147	00826	141	00928	225	01094	150
00686	147	00827	141	00929	225	01095	150
00687	147	00828	141	00930	225	01096	150
00689	147	00829	141	00931	225	01097	150
00690	147	00830	141	00933	225	01098	150
00691	147	00831	141	00934	225	01121	221
00692	147	00832	141	00937	225	01122	221
00694	147	00833	133	00953	216	01123	221
00695	147	00834	133	00965	226	01124	221
00696	147	00846	141	00966	226	01126	221
00697	147	00847	141	00967	226	01128	221
00698	147	00848	141	00968	226	01130	221
00700	147	00849	141	00969	226	01131	221
00701	147	00850	141	00971	226	01132	221
00702	147	00853	142	00972	226	01133	221
00703	147	00855	142	00973	226	01134	221
00704	147	00856	142	00974	226	01135	221



n° pdo.	Página	n° pdo.	Página	n° pdo.	Página	n° pdo.	Página
01136	221	01345	228	01681	246	01913	261
01137	221	01348	217	01688	246	01919	261
01138	221	01350	229	01689	246	01922	259
01139	221	01351	229	01690	246	01923	259
01140	221	01352	229	01703	247	01924	259
01141	221	01353	229	01704	247	01926	259
01142	221	01354	229	01705	247	01927	259
01143	221	01355	229	01706	247	01930	259
01285	148	01356	229	01707	247	01933	258
01286	148	01391	220	01708	247	01935	258
01287	148	01392	219	01709	247	01937	256
01288	148	01393	219	01710	247	01938	256
01289	148	01395	219	01711	246	01939	256
01290	148	01396	219	01712	246	01940	256
01291	148	01398	219	01713	246	01942	256
01292	148	01400	219	01714	246	01943	256
01293	148	01402	219	01715	246	01945	256
01294	148	01404	219	01716	246	01946	256
01295	148	01406	219	01717	246	01947	257
01296	148	01408	219	01718	246	<b>02</b>	
01297	148	01416	209	01719	246	02091	328
01299	143	01418	209	01720	246	02092	328
01300	148	01420	210	01721	246	02093	328
01301	148	01422	220	01722	246	02094	328
01302	148	01423	220	01723	246	02095	328
01303	148	01424	220	01724	246	02096	328
01304	148	01425	220	01726	246	02097	328
01305	148	01426	220	01727	246	02098	328
01306	148	01427	220	01728	246	02099	328
01310	223	01428	220	01729	246	02101	328
01311	223	01429	220	01730	246	02102	329
01312	223	01430	220	01731	246	02103	329
01313	223	01431	220	01732	246	02104	329
01314	223	01432	220	01733	246	02105	329
01315	223	01433	220	01734	247	02106	329
01316	223	01434	220	01735	247	02107	329
01317	223	01435	150	01736	247	02108	329
01318	223	01436	150	01737	247	02109	329
01319	223	01437	150	01738	247	02110	329
01320	223	01438	150	01739	247	02111	329
01321	223	01439	150	01740	247	02113	329
01322	223	01440	150	01790	250	02114	329
01323	223	01443	150	01791	250	02115	329
01324	223	01475	262	01792	250	02116	329
01326	214	01476	262	01793	250	02117	329
01328	228	01479	262	01794	250	02122	328
01329	228	01481	263	01795	250	02123	328
01330	228	01508	155	01796	250	02124	328
01331	228	01537	154	01798	250	02125	328
01332	228	01538	154	01799	250	02126	328
01333	228	01539	154	01800	250	02127	328
01334	228	01548	154	01803	250	02128	328
01335	228	01623	246	01805	250	02129	328
01336	228	01624	246	01808	250	02292	209
01337	228	01626	246	01809	250	02568	155
01338	228	01627	246	01811	250	02802	226
01339	228	01649	246	01812	250	02803	226
01340	228	01657	246	01894	261	02804	226
01341	228	01658	246	01895	261	02805	226
01343	228	01659	246	01910	261	02806	226

# Registro de números de referencia

n° pdo.	Página	n° pdo.	Página	n° pdo.	Página	n° pdo.	Página
02807	226	03853	160	04925	246	07855	248
02808	226	03854	160	04926	246	07856	248
02809	226	03868	220	04927	246	07857	248
02810	226	03869	220	04928	246	07859	248
02811	226	03870	220	04929	246	07860	248
02819	227	03871	220	04930	246	07861	248
02820	227	03872	220	04931	246	07869	261
02821	227	03873	220	<b>05</b>		07922	219
02822	227	03874	220	05271	142	07943	244
02823	227	03875	220	05298	246	<b>08</b>	
02824	227	03876	220	05300	246	08047	249
02836	150	03879	210	05301	252	08048	249
02837	150	03882	199	05302	252	08049	249
02838	150	03883	199	05303	252	08056	249
02839	150	03988	160	05638	220	08057	249
02840	150	03992	210	05799	250	08058	249
02939	210	<b>04</b>		05800	250	08065	249
<b>03</b>		04009	250	<b>06</b>		08066	249
03106	148	04010	250	06059	220	08067	249
03107	148	04011	247	06218	221	08068	249
03108	148	04059	250	06358	220	08069	249
03115	246	04096	225	06359	220	08070	249
03117	246	04099	225	06360	220	08179	158
03186	203	04105	225	06361	220	08182	158
03223	151	04108	225	06362	220	08183	158
03224	151	04111	225	06363	220	08184	158
03225	151	04126	250	06364	220	08185	158
03226	151	04127	250	06365	220	08186	158
03228	151	04176	250	06366	220	08421	248
03230	151	04194	252	06367	220	08422	248
03231	151	04195	252	06368	220	08423	248
03232	151	04196	252	06369	220	08424	248
03237	151	04197	252	06370	220	08425	248
03238	151	04198	252	06371	220	08426	248
03239	151	04204	258	06378	211	08900	199
03245	151	04362	258	06379	210	08901	199
03246	151	04508	258	06382	211	08902	199
03247	151	04509	258	06386	210	08903	199
03591	195	04510	258	06634	247	08904	199
03723	209	04511	258	06635	247	08905	199
03724	229	04512	258	06636	247	08906	199
03725	229	04513	258	06637	252	08907	199
03726	229	04514	258	06638	252	08908	199
03727	229	04631	258	06639	252	08909	199
03728	229	04632	258	06725	160	08911	199
03729	229	04633	258	06726	160	<b>09</b>	
03730	229	04634	258	06727	160	09195	203
03731	229	04635	258	06728	160	09393	244
03738	147	04636	258	06729	160	<b>20</b>	
03739	147	04637	258	06730	160	20218	252
03760	141	04638	258	06731	160	20219	252
03761	141	04639	258	06732	160	20220	252
03762	141	04640	258	06888	250	20221	252
03764	223	04670	257	06889	250	20222	252
03847	160	04671	257	<b>07</b>		20223	252
03848	160	04677	256	07152	143	20224	252
03849	160	04678	256	07153	143	20549	218
03850	160	04684	258	07155	143	20550	218
03851	160	04685	258	07185	208	20551	218
03852	160	04918	229	07192	208	20552	218

n° pdo.	Página	n° pdo.	Página	n° pdo.	Página	n° pdo.	Página
20553	218	23040	192	24313	222	<b>26</b>	
20554	194	23041	192	24314	222	26000	252
20555	247	23047	190	24315	222	26002	252
20556	247	23049	190	24316	222	26045	247
20557	247	23051	190	24317	222	26047	174
20558	247	23053	190	24318	222	26048	174
20559	247	23145	252	24319	222	26049	174
20560	247	23147	252	24320	222	26051	174
20570	218	23149	252	24321	222	26052	174
20783	194	23151	252	24322	222	26053	174
<b>21</b>		23159	155	24323	222	26058	176
21045	252	23173	246	24324	222	26059	176
21047	252	23175	246	24325	222	26060	176
21248	144	23177	246	24341	218	26061	176
21249	144	23179	246	24506	143	26062	176
21250	145	23181	246	24515	222	26063	176
21251	145	23183	246	24517	222	26064	176
21960	225	23185	246	24519	222	26065	176
21962	225	23187	246	24521	222	26066	176
<b>22</b>		23189	246	24523	222	26067	176
22096	216	23191	246	24525	222	26068	176
22168	225	23193	246	24527	222	26069	176
22170	225	23195	252	24529	222	26070	176
22172	225	23197	252	24531	222	26071	176
22174	225	23199	252	24533	222	26072	176
22436	158	23201	252	24733	248	26073	176
22509	250	23203	252	24742	248	26077	148
22510	250	23205	252	24746	248	26079	148
22511	250	23207	252	24748	248	26081	148
22512	250	23209	252	24750	248	26083	148
22591	247	23211	252	24851	208	26085	148
22592	247	23213	250	24852	214	26091	148
22593	247	23215	250	24867	252	26093	148
22594	247	23217	250	<b>25</b>		26095	148
22595	247	23219	250	25097	246	26097	148
22596	252	23221	250	25128	191	26099	148
22597	252	23223	250	25130	191	26101	148
22598	252	23225	250	25164	191	26103	148
22599	252	23226	250	25166	191	26105	148
22600	252	23227	250	25293	190	26107	148
22603	247	23228	250	25295	190	26109	148
22604	247	<b>24</b>		25477	133	26111	148
22605	247	24107	223	25560	247	26113	143
22606	247	24109	223	25561	247	26122	203
22607	247	24111	223	25562	247	26123	203
22608	247	24113	223	25563	247	26124	203
22655	248	24115	223	25564	247	26127	174
22955	247	24117	223	25572	247	26128	174
22956	247	24119	223	25624	217	26129	174
22957	247	24121	223	25625	217	26130	174
22958	247	24123	223	25679	248	26131	174
22959	247	24189	208	25681	248	26133	174
22960	247	24302	218	25739	252	26135	224
22961	247	24303	218	25740	252	26136	224
22962	247	24304	218	25741	252	26137	224
<b>23</b>		24305	218	25742	252	26138	224
23031	192	24306	218	25874	262	26139	224
23033	192	24307	218	25994	246	26140	224
23035	193	24308	218	25996	246	26146	144
23037	193	24312	214	25998	246	26148	176

# Registro de números de referencia

n° pdo.	Página	n° pdo.	Página	n° pdo.	Página	n° pdo.	Página
26151	176	26234	149	26457	148	26704	294
26152	176	26247	216	26458	148	26705	278
26154	176	26248	216	26461	174	26706	295
26155	176	26249	247	26462	174	26707	294
26156	176	26250	246	26463	174	26708	278
26157	176	26252	245	26464	174	26709	295
26158	176	26253	245	26509	325	26710	294
26159	176	26259	148	26510	327	26711	278
26164	224	26260	148	26511	327	26712	295
26165	224	26261	217	26512	327	26713	295
26166	224	26277	176	26513	327	26714	278
26167	224	26278	176	26514	327	26715	295
26168	224	26279	176	26544	176	26716	295
26169	224	26303	148	26582	326	26717	278
26170	224	26304	148	26611	325	26718	296
26171	224	26305	148	26612	325	26719	296
26172	224	26307	148	26613	325	26720	279
26173	224	26309	247	26614	325	26721	296
26174	224	26327	174	26615	327	26722	296
26175	224	26328	148	26616	327	26723	297
26176	224	26329	148	26618	327	26724	296
26177	224	26330	148	26620	327	26725	297
26178	224	26331	148	26625	166	26726	296
26179	263	26332	148	26626	166	26727	279
26181	229	26333	148	26627	166	26728	280
26182	229	26346	246	26629	181	26729	280
26183	229	26347	246	26640	326	26730	298
26184	229	26348	246	26641	326	26731	298
26185	229	26349	246	26642	326	26732	280
26186	229	26350	246	26643	326	26733	299
26187	229	26351	246	26644	326	26734	299
26188	229	26352	247	26645	326	26735	280
26190	148	26353	247	26646	326	26745	276
26191	148	26354	247	26647	326	26755	104
26192	148	26355	247	26648	326	26757	302
26193	148	26356	247	26649	325	26758	302
26194	148	26417	327	26650	325	26759	302
26195	148	26418	327	26651	325	26760	300
26196	176	26419	327	26652	325	26761	300
26197	176	26420	327	26653	325	26762	300
26198	176	26421	327	26654	325	26763	300
26199	176	26422	326	26655	325	26764	301
26200	176	26423	326	26656	325	26765	301
26212	150	26424	326	26657	326	26766	300
26213	150	26425	326	26658	326	26767	301
26214	150	26426	326	26659	326	26771	302
26216	150	26427	326	26660	326	26772	302
26217	150	26428	326	26661	326	26773	302
26221	176	26429	326	26663	326	26774	302
26222	176	26430	326	26664	326	26775	302
26223	176	26431	325	26665	326	26776	302
26224	176	26432	325	26666	326	26777	302
26225	176	26433	325	26667	327	26778	302
26227	176	26434	325	26668	327	26779	302
26228	176	26435	325	26669	327	26780	302
26229	177	26436	325	26670	327	26781	305
26230	149	26437	325	26671	327	26782	305
26231	149	26439	325	26672	327	26783	305
26232	149	26454	147	26674	326	26784	305
26233	149	26455	147	26703	295	26785	305

n° pdo.	Página	n° pdo.	Página	n° pdo.	Página	n° pdo.	Página
26786	305	26959	228	27374	302	27627	198
26787	305	26960	228	27375	302	27628	198
26788	305	26964	152	27376	302	27629	198
26789	305	26965	152	27377	302	27630	198
26790	305	26966	152	27378	302	27631	198
26791	305	26967	152	27379	302	27632	198
26792	305	26968	152	27380	302	27633	198
26793	290	26969	152	27381	300	27634	198
26794	305	26970	152	27382	300	27641	158
26795	305	26971	152	27383	301	27712	197
26796	305	26972	152	27384	301	27713	196
26797	305	26973	152	27388	316	27736	147
26799	312	<b>27</b>		27390	317	27737	147
26801	317	27055	333	27391	316	27738	147
26802	312	27057	333	27393	316	27739	147
26804	312	27058	333	27395	316	27740	147
26806	312	27059	333	27397	317	27741	147
26808	309	27061	333	27398	317	27742	147
26812	316	27062	333	27399	294	27743	147
26813	317	27064	247	27418	278	27744	147
26814	309	27065	247	27419	278	27745	147
26815	316	27066	247	27420	278	27746	143
26816	309	27067	247	27421	278	27753	147
26818	316	27077	249	27422	279	27754	147
26821	310	27079	176	27423	279	27755	147
26822	310	27082	332	27424	280	27756	147
26825	316	27083	332	27425	280	27757	147
26826	310	27144	158	27426	280	27758	147
26830	317	27145	158	27427	280	27811	147
26831	310	27146	158	27431	276	27812	176
26832	311	27147	158	27437	282	27813	176
26833	317	27148	158	27439	312	27814	176
26835	311	27149	158	27440	312	27815	176
26839	311	27150	158	27441	312	27816	176
26840	311	27151	158	27442	309	27817	176
26845	283	27252	157	27443	309	27818	176
26846	283	27253	157	27444	309	27820	200
26847	282	27256	247	27445	310	27892	257
26850	289	27257	247	27446	310	27893	257
26852	274	27258	247	27447	310	27894	257
26853	288	27259	247	27448	310	27895	257
26854	289	27260	247	27449	311	27896	257
26864	177	27325	295	27450	311	27897	257
26865	181	27326	317	27452	311	27898	257
26866	181	27327	294	27453	311	27899	257
26888	174	27328	278	27501	302	27900	257
26889	176	27329	312	27502	302	27901	257
26893	173	27336	295	27503	302	27905	312
26901	174	27337	295	27504	302	27928	227
26920	155	27340	296	27526	177	27929	227
26925	174	27341	296	27530	246	27930	227
26928	158	27342	297	27606	155	27931	227
26929	158	27343	297	27614	229	27932	227
26931	147	27344	298	27615	229	27933	227
26953	228	27345	299	27616	229	27934	227
26954	228	27350	300	27617	229	27935	227
26955	228	27351	301	27618	229	27936	190
26956	228	27368	283	27619	229	27963	257
26957	228	27372	302	27620	229	27964	228
26958	228	27373	302	27621	229	27965	228

# Registro de números de referencia

n° pdo.	Página	n° pdo.	Página	n° pdo.	Página	n° pdo.	Página
27966	228	29159	156	30700	141	32304	251
27967	228	29162	156	30701	141	32305	251
27968	228	29163	156	30715	141	32306	251
27970	228	29164	156	30716	141	32307	251
27971	228	29165	156	30824	113	32308	251
<b>28</b>		29228	178	30826	294	32309	251
28005	148	29229	178	30852	176	32310	263
28026	257	29230	178	30978	294	32311	263
28027	257	29231	178	30979	294	32318	313
28051	329	29232	178	<b>31</b>		32319	295
28052	329	29233	178	31233	221	32320	295
28058	257	29234	178	31234	221	32322	296
28330	286	29236	178	31235	221	32323	296
28372	224	29416	241	31236	221	32324	297
28373	224	29417	241	31237	221	32325	313
28374	224	29420	288	31238	221	32326	313
28375	224	29422	332	31239	221	32327	313
28376	224	29425	305	31240	221	32328	297
28377	224	29427	305	31241	221	32329	313
28402	306	29428	305	31242	221	32330	298
28481	252	29429	305	31243	221	32332	299
28691	172, 179	29435	306	31244	221	32334	314
28734	179	29436	306	31432	158	32335	314
28735	179	29437	306	31439	332	32336	314
28736	179	29441	306	31496	198	32338	314
28737	179	29442	306	31497	197	32340	314
28738	179	29443	306	31498	202	32342	300
28739	179	29463	262	31499	202	32343	315
28740	179	29466	134	31771	142	32344	315
28741	179	29467	176	31863	141	32345	283
28742	179	29471	219	31901	158	32346	314
28743	179	29472	219	31957	250	32347	313
28744	179	29473	219	31958	250	32349	308
28745	179	29474	219	31959	250	32352	301
28746	179	29475	219	31960	250	32383	147
28747	179	29485	307	31961	250	32384	147
28748	179	29486	307	31962	250	32386	221
28749	179	29487	307	<b>32</b>		32387	221
28756	179	29544	249	32055	248	32388	221
28757	179	29550	306	32070	248	32389	221
28758	179	29553	176	32071	248	32390	221
28760	148	29554	176	32105	250	32391	221
28761	148	29555	176	32160	262	32392	221
28762	148	29556	176	32161	263	32393	221
28763	148	29557	176	32201	142	32394	213
28764	148	29558	176	32250	147	32395	213
28765	148	29559	176	32251	147	32396	141
28766	148	29560	176	32252	147	32397	141
<b>29</b>		<b>30</b>		32253	147	32399	147
29133	156	30050	247	32254	147	32400	147
29134	156	30066	286	32255	147	32404	151
29135	156	30361	141	32256	147	32405	151
29136	156	30362	141	32264	148	32406	151
29137	156	30363	141	32265	148	32410	251
29138	156	30364	141	32281	133	32411	251
29139	156	30365	141	32282	133	32412	251
29149	156	30366	141	32298	196	32413	251
29150	156	30372	198	32299	251	32414	251
29151	156	30373	202	32302	251	32415	251
29158	156	30495	181	32303	251	32416	251

n° pdo.	Página	n° pdo.	Página	n° pdo.	Página	n° pdo.	Página
32417	251	33717	251	34312	300	34736	214
32418	251	33718	251	34313	283	34740	212
32419	251	33719	251	34452	251	34745	142
32421	251	33720	251	34453	251	34746	248
32423	251	33721	251	34454	251	<b>35</b>	
32477	260	33722	251	34455	251	35378	142
32484	263	33723	251	34456	251	35389	132
32490	250	33724	251	34457	251	35390	140
32491	250	33725	251	34515	296	35391	140
32492	250	33726	251	34518	301	35392	140
32493	250	33727	251	34533	174	35393	140
32494	250	33728	251	34554	252	35394	140
32495	250	33729	251	34555	252	35395	140
32496	250	33730	251	34556	252	35396	140
32497	250	33731	251	34557	252	35397	151
32505	256	33732	251	34558	252	35398	151
32547	259	33736	189	34559	252	35400	256
32556	259	33738	189	34560	252	35401	256
32573	259	33740	189	34565	294	35402	256
32686	250	33741	189	34567	295	35403	256
32687	250	33743	189	34568	299	35446	140
32688	250	33744	189	34569	297	35456	250
32689	250	33746	189	34570	297	35457	250
32804	254	33749	221	34577	135	35462	280
32867	151	33753	212	34578	170, 138	35465	278
32868	151	33754	212	34579	170, 138	35477	279
32869	151	33764	189	34580	170, 138	35480	208
32870	151	33841	287	34581	170, 138	35481	208
32871	151	33842	288	34582	170, 138	35482	219
32901	189	33843	287	34583	170, 138	35483	219
32902	189	33844	287	34584	170, 138	35484	219
32903	189	33848	201	34585	170, 138	35485	219
<b>33</b>		33920	251	34586	170, 138	35486	219
33007	189	33921	251	34587	170, 138	35487	219
33008	189	33922	251	34588	170, 138	35488	219
33009	189	33923	251	34589	170, 138	35489	219
33178	279	33924	251	34590	170, 138	35490	219
33186	278	33925	251	34614	173	35501	140
33232	333	33926	251	34686	244	35502	140
33251	333	33927	251	34688	304	35503	140
33471	318	33928	251	34689	304	35504	140
33472	318	33929	251	34690	304	35505	140
33503	201	33930	251	34691	304	35506	138, 170
33507	308	33931	251	34692	304	35507	138, 170
33520	282	33932	251	34693	304	35508	138, 170
33521	309	33961	250	34694	304	35509	138, 170
33703	250	33962	250	34695	304	35510	138, 170
33704	250	33963	250	34696	304	35511	138, 170
33705	250	33964	250	34697	304	35709	248
33706	250	33965	250	34698	304	35820	318
33707	250	33966	250	34699	304	35832	248
33708	250	33969	103	34700	304	35834	249
33709	251	33970	112	34701	304	35861	286
33710	251	33971	112	34702	304	35862	286
33711	251	<b>34</b>		34703	304	35870	168
33712	251	34306	261	34704	304	<b>36</b>	
33713	251	34307	294	34705	304	36038	300
33714	251	34308	294	34706	304	36039	300
33715	251	34309	296	34707	304	36040	301
33716	251	34310	298	34708	290	36041	301

# Registro de números de referencia

n° pdo.	Página	n° pdo.	Página	n° pdo.	Página	n° pdo.	Página
36053	285	36462	215	38371	251	38801	180
36071	138, 170	36483	297	38372	251	38802	180
36072	151	36487	212	38552	275	38803	180
36079	168	36503	211	38556	180	38804	180
36082	253	36521	207	38557	180	38805	180
36085	151	36536	140	38558	180	38806	180
36086	253	36537	140	38600	189	38807	180
36092	261	36538	140	38601	189	38808	180
36093	261	36539	140	38605	189	38809	180
36094	261	36540	140	38606	189	38810	180
36112	261	36541	140	38610	186	38811	180
36114	194	36542	140	38611	186	38812	180
36189	298	36558	132	38612	186	38813	180
36193	253	36711	282	38613	186	38814	180
36218	304	36791	164	38616	180	38815	180
36219	304	36794	318	38617	180	38816	180
36220	304	36800	260	38618	180	38817	180
36221	304	36846	175	38619	180	38818	180
36222	304	36847	175	38620	180	38819	180
36223	304	36849	174	38621	180	38820	180
36224	304	36850	174	38622	180	38821	180
36225	304	36851	181	38627	275	38853	275
36226	304	36852	181	38631	282	38854	275
36229	175	36886	172	38632	282	38855	278
36230	175	36887	172	38637	274	38856	278
36231	175	36888	172	38649	248	38857	279
36233	175	36951	241	38650	248	38858	279
36234	175	36975	304	38651	248	38859	280
36235	175	36976	304	38652	248	38867	282
36236	175	36977	304	38653	248	38918	171
36237	175	36978	304	38654	248	38919	171
36238	175	36979	304	38656	248	38920	171
36239	175	36980	304	38657	248	38921	171
36240	175	36985	300	38658	248	38925	171
36272	304	36986	300	38659	248	38926	171
36275	248	36987	301	38660	248	38927	171
36280	248	36988	301	38676	253	38928	171
36282	248	36990	240	38677	253	38929	171
36285	249	<b>37</b>		38679	253	38930	171
36288	248	37067	332	38680	253	38931	171
36310	245	37147	138, 170	38681	253	38932	171
36320	175	37222	138, 170	38684	253	38933	171
36321	175	37223	138, 170	38685	253	38934	171
36327	251	37224	138, 170	38686	253	38935	171
36329	140	37225	138, 170	38687	253	38936	171
36330	140	37226	138, 170	38689	253	38981	291
36333	132	37227	138, 170	38690	253	38982	291
36388	111	37351	207	38706	253	38983	291
36389	102	37402	297	38707	253	38984	276
36390	111	37403	297	38708	253	38985	286
36414	177	37450	282	38709	253	38986	286
36415	177	<b>38</b>		38710	253	<b>39</b>	
36417	177	38020	103	38711	253	39008	328
36418	177	38060	291	38712	253	39010	328
36421	177	38074	166	38713	253	39012	328
36452	219	38189	291	38714	253	39014	328
36453	209	38190	291	38715	253	39017	328
36455	132	38191	276	38717	253	39019	328
36459	215	38362	132	38798	285	39021	328
36461	214	38370	251	38800	180	39022	328



n° pdo.	Página	n° pdo.	Página	n° pdo.	Página	n° pdo.	Página
39029	242	39374	307	40628	255	41002	143
39037	242	39375	307	40629	255	41003	131
39039	242	39376	307	40630	255	41015	318
39040	242	39377	307	40631	255	41141	140
39041	242	39378	307	40632	255	41142	140
39045	242	39379	307	40633	255	41143	140
39049	243	39380	307	40634	255	41144	140
39056	243	39381	307	40635	255	41145	140
39057	243	39382	248	40636	255	41146	140
39059	243	39875	247	40637	255	41147	140
39060	243	39964	256	40638	255	41157	186
39076	194	39971	254	40639	255	41158	186
39078	242	<b>40</b>		40640	255	41159	138, 170
39083	243	40331	262	40641	255	41160	138, 170
39091	301	40342	287	40642	255	41220	303
39093	301	40401	219	40643	255	41221	303
39094	301	40402	219	40644	255	41222	318
39095	301	40403	219	40645	255	41230	134
39104	213	40404	219	40646	256	41231	130
39105	213	40405	219	40647	256	41232	130
39106	222	40406	219	40648	256	41233	130
39107	222	40407	219	40649	256	41234	186
39108	222	40408	219	40650	256	41235	186
39109	222	40409	219	40651	256	41241	102
39110	222	40410	209	40652	256	41245	132
39111	222	40411	209	40653	256	41246	286
39112	222	40461	249	40654	256	41261	293
39113	222	40462	249	40655	256	41266	293
39114	222	40463	249	40656	256	41272	293
39115	222	40464	249	40657	256	41273	292
39116	222	40465	249	40658	256	41274	277
39117	222	40523	99	40659	256	41275	277
39118	222	40600	255	40660	256	41277	293
39124	242	40601	255	40661	256	41278	292
39133	260	40602	255	40663	256	41279	277
39134	260	40603	255	40674	165	41280	277
39149	329	40604	255	40712	303	41286	124
39150	329	40605	255	40713	303	41289	330
39151	329	40606	255	40913	293	41301	293
39152	329	40607	255	40919	293	41307	293
39178	252	40608	255	40920	292	41309	277
39179	252	40609	255	40921	277	41310	277
39180	252	40610	255	40922	277	41311	293
39181	252	40611	255	40923	300	41317	293
39182	252	40612	255	40927	279	41318	292
39183	252	40613	255	40966	222	41319	277
39184	251	40614	255	40967	222	41320	277
39185	251	40615	255	40968	222	41321	293
39186	251	40616	255	40969	222	41327	293
39187	251	40617	255	40970	222	41329	277
39188	252	40618	255	40971	222	41330	277
39189	252	40619	255	40972	222	41341	167
39190	252	40620	255	40973	222	41342	167
39191	252	40621	255	40974	222	41343	167
39192	252	40622	255	40975	222	41344	167
39193	252	40623	255	40976	222	41345	167
39194	252	40624	255	40977	222	41476	167
39206	252	40625	255	40978	222	41477	167
39207	252	40626	255	40979	213	41478	167
39208	252	40627	255	<b>41</b>		41479	167

# Registro de números de referencia

n° pdo.	Página	n° pdo.	Página	n° pdo.	Página	n° pdo.	Página
41483	206	41660	237	42116	232	42398	153
41585	240	41662	237	42117	232	42399	153
41586	240	41663	237	42118	232	42401	153
41587	240	41824	236	42119	233	42402	153
41588	240	41825	236	42120	233	42403	153
41589	240	41826	236	42121	233	42413	153
41590	240	41827	239	42122	233	42414	153
41591	240	41828	239	42123	233	42415	153
41592	240	41829	239	42124	233	42416	153
41593	240	41830	236	42125	233	42418	153
41594	240	41831	236	42126	233	42419	153
41596	240	41832	238	42127	233	42420	153
41597	240	41833	238	42128	233	42421	153
41598	237	41834	238	42129	233	42422	153
41599	237	41894	218	42130	233	42423	153
41600	237	41895	218	42131	233	42424	153
41601	237	41896	218	42132	233	42425	153
41602	237	41897	218	42133	233	42426	153
41603	237	41898	218	42134	233	42427	154
41604	237	41899	218	42135	234	42428	154
41605	237	41900	218	42136	234	42429	154
41606	237	41901	218	42137	234	42430	154
41607	237	41902	218	42138	234	42431	153
41609	237	41914	122	42139	234	42432	153
41610	237	41915	122	42149	235	42433	153
41611	237	41922	261	42150	235	42434	153
41612	237	41923	288	42162	284	42435	153
41613	237	41973	218	42292	237	42436	153
41614	237	41974	218	42293	237	42437	153
41621	237	41975	218	42294	240	42438	153
41622	237	41976	218	42295	240	42439	153
41623	237	41977	218	42301	237	42440	153
41624	239	41978	218	42302	237	42441	153
41625	239	41979	206	42303	240	42442	153
41626	239	<b>42</b>		42304	240	42443	154
41627	239	42062	284	42305	240	42444	154
41628	239	42068	332	42306	237	42445	154
41629	239	42071	330	42374	142	42446	154
41630	239	42074	331	42375	142	42447	154
41631	239	42086	126	42376	142	42448	154
41632	239	42096	235	42377	142	42449	154
41633	239	42097	233	42378	142	42450	154
41635	239	42098	234	42379	142	42451	154
41636	239	42099	232	42380	142	42452	154
41637	237	42100	235	42381	153	42453	154
41638	237	42101	235	42382	153	42454	154
41639	237	42102	235	42383	153	42455	154
41640	237	42103	235	42384	153	42464	153
41641	237	42104	235	42385	153	42465	153
41642	237	42105	235	42386	153	42466	153
41643	237	42106	235	42387	153	42467	153
41644	237	42107	235	42388	153	42468	153
41645	237	42108	235	42389	153	42469	153
41646	237	42109	235	42390	153	42470	153
41648	237	42110	235	42391	153	42471	142
41649	237	42111	235	42392	153	42474	153
41650	237	42112	235	42393	153	42475	153
41651	237	42113	235	42394	153	42476	153
41652	237	42114	232	42395	153	42477	153
41653	237	42115	232	42397	153	42478	153

n° pdo.	Página	n° pdo.	Página	n° pdo.	Página	n° pdo.	Página
42479	153	43058	109	43126	172	43464	276
42480	153	43059	109	43128	168	43465	101
42481	153	43060	109	43139	135	43466	107
42482	153	43061	108	43140	138, 170	43467	107
42483	153	43062	108	43141	138, 170	43474	101
42484	153	43063	108	43142	138, 170	43538	281
42485	153	43065	109	43143	138, 170	43541	281
42501	153	43066	109	43144	138, 170	43544	281
42502	153	43067	109	43145	138, 170	43547	281
42503	153	43068	109	43146	138, 170	43613	187
42504	153	43069	109	43147	138, 170	43631	123
42505	153	43070	109	43148	138, 170	43634	172
42506	153	43071	109	43149	138, 170	43660	281
42507	154	43072	109	43150	138, 170	43661	281
42539	235	43073	109	43151	138, 170	43662	281
42548	235	43074	109	43152	136, 168	43663	281
42549	235	43075	109	43153	136, 168	43664	281
42550	235	43076	109	43154	136, 168	43665	281
42551	235	43077	109	43155	136, 168	43666	281
42766	122	43078	109	43156	136, 169	43667	281
42989	135	43079	109	43157	137, 169	43669	159
42990	145	43080	109	43158	137, 169	43670	159
42991	145	43081	109	43159	137, 169	43671	159
42992	146	43082	109	43160	121, 137, 169	43672	159
42993	146	43083	109	43161	136, 169	43673	159
42994	146	43084	109	43162	136, 169	43674	159
42995	146	43085	109	43163	139	43675	159
42996	145	43086	109	43164	139	43676	159
42997	145	43087	109	43167	134	43677	159
42998	145	43088	109	43177	171	43678	159
<b>43</b>		43089	109	43240	298	43679	159
43022	106	43090	109	43292	135	43680	159
43023	105	43091	109	43304	292	43681	159
43024	105	43092	109	43324	292	43682	159
43025	106	43093	109	43325	292	43683	159
43026	108	43094	109	43326	276	43684	159
43027	108	43095	109	43327	276	43685	159
43028	108	43096	109	43332	292	43686	159
43029	108	43097	109	43333	292	43687	159
43030	108	43098	109	43334	292	43688	159
43031	108	43099	109	43335	276	43689	159
43032	108	43100	110	43336	276	43690	159
43033	108	43101	110	43337	292	43691	159
43034	108	43102	110	43338	292	43692	159
43035	108	43103	110	43339	292	43693	159
43036	108	43104	110	43340	276	43694	159
43037	108	43105	110	43341	276	43695	159
43038	108	43106	110	43449	134	43696	159
43039	108	43107	110	43450	292	43697	159
43040	108	43108	110	43451	292	43698	159
43041	108	43109	110	43453	276	43699	159
43042	108	43110	110	43454	276	43700	159
43043	108	43111	110	43455	292	43701	159
43044	108	43112	110	43456	292	43702	159
43052	108	43113	110	43457	292	43703	159
43053	108	43114	138, 170	43458	276	43704	159
43054	108	43115	138, 170	43459	276	43705	159
43055	109	43116	138, 170	43460	292	43706	159
43056	109	43117	138, 170	43461	292	43707	158
43057	109	43125	285	43463	276	43708	158

# Registro de números de referencia

n° pdo.	Página	n° pdo.	Página	n° pdo.	Página
43709	263	43952	342, 343	44620	285
43797	125	43953	342, 343	44684	267
43798	125	43954	344	<b>45</b>	
43847	212	43955	344	45223	287
43848	211	43956	344	<b>73</b>	
43849	206	43957	344	73917	341
43850	206	43958	344		
43852	207	43959	344		
43858	188	43960	344		
43859	188	43961	344		
43860	188	43962	344		
43861	188	43963	344		
43862	188	43964	344		
43863	188	43965	345		
43864	188	43966	345		
43865	188	43967	345		
43866	188	43968	345		
43867	188	43969	345		
43868	188	43970	345		
43869	188	43971	346		
43870	188	43972	346		
43879	100	43973	346		
43882	153	43974	346		
43894	149	43975	346		
43895	187	43976	346		
43898	181	43982	116, 336		
43899	339	43984	116, 336		
43900	339	43985	115, 337		
43903	339	43987	115, 337		
43904	339	43994	113		
43905	339	43995	117, 337		
43907	339	43996	340, 341		
43908	340, 341	<b>44</b>			
43909	340, 341	44001	194		
43910	340, 341	44005	338		
43911	340, 341	44007	338		
43912	340, 341	44008	324		
43913	340, 341	44106	121, 137		
43914	340, 341	44107	137, 137		
43915	340, 341	44128	97		
43916	340, 341	44163	172		
43917	340	44240	285		
43918	340, 341	44241	285		
43919	340, 341	44242	285		
43927	340, 341	44309	125		
43928	340, 341	44314	282		
43932	340, 341	44318	120		
43933	340, 341	44319	125		
43934	340, 341	44351	120		
43935	342, 343	44355	172		
43936	342, 343	44363	122		
43937	342, 343	44364	122		
43938	342, 343	44366	121, 137		
43939	342, 343	44367	114		
43940	342, 343	44385	138, 170		
43941	342, 343	44574	104		
43942	342, 343	44576	114		
43947	342, 343	44617	284		
43948	342, 343	44618	284		
43951	342, 343	44619	284		



# Registro de números de artículos

Artículo n°.	Página	Artículo n°.	Página	Artículo n°.	Página	Artículo n°.	Página
<b>22</b>		269ESD	202	283696	180	29701280S4	167
22 0 05	300	269SE	203	283793	171	29701S5	167
2270P	142	269T11	200	283794	171	<b>30</b>	
2270PK601	135	269T1101	200	283795	171	300	154
2271P	142	269T4	200	283799	172	301	154
<b>24</b>		269T6	200	283799	172	302	147
246	331	<b>27</b>		284	198	3021	151
24601	194	270P	159	28400	198	3022	147
246176	285	270PK601	158	28401	198	3023	149
24618T	108	271P	159	28411	198	302ESD	158
24628	263	273P	159	28422	198	302ESDHK501	157
24629	263	275P	159	28437	198	302HK12	143
24636	259	276P	159	2844	199	302HK601	143
24636B5	259	276PY	159	28455	198	302HK6SO	143
24667	194	277P	159	284ESD	198	302SY	152
24670	124	277PK601	158	284ESDT601	197	302ZK6SO	143
24678	285	278P	159	284TR	198	303190	270
24680	285	<b>28</b>		2850	174	30390	271
24681	194	281	262	2850	175	30391	270
24682	194	281	262	2852	174	308	152
<b>25</b>		281	263	2852S10	173	308HK6	144
25511	142	281B11	195	2852S1001	173	308ZK6	144
25513	125	281P	263	2859	177	<b>31</b>	
25513	125	281T11	195	28590	176	311	147
25514	125	281T601	196	28591	176	3111	151
25515	125	2822	172	28592	176	311ESD	158
2553	142	2831	135	28593	176	311K6	144
2557	142	2831	135	28594	177	311SY	152
<b>26</b>		2831	135	28595	176	312	152
260P	153	2831	139	28595R	176	313	147
260PK601	145	283109020	186	28596	176	313ESD	158
260PK701	145	283109021	186	28596R	176	313SY	152
2611P	153	283109022	186	28597	176	314	152
261P	153	283109023	186	28599	177	<b>32</b>	
262P	153	283110	138	28599	177	3201	140
263P	153	283110	138	2872	166	3201K12	131
263PK601	146	283110	170	2872T13	165	3201K6	132
263PZ	154	283111	138	2872T18	164	3201K601	132
264P	153	283111	170	28799	168	3201ZK6	132
264PK601	146	283112	138	28799	168	320N	141
264PZ	153	283112	170	28799B7	168	320NK6	133
265P	154	283113	138	2882	181	320NK7	133
265PK601	146	283113	170	2882S13	181	320NZK6SO	133
266P	153	283114	138	2891	178	3211	140
266PK801	146	283114	170	2893	178	321N	141
266PY	153	283115	138	2893S01	178	322	142
267PK601	145	283115	170	2899	172	322K5	134
267PK6M01	145	283116	138	2899	179	323N	141
267PR	153	283116	170	28993	179	324	141
267PR	153	283117	138	28995	179	3241	140
267PRK601	145	283117	170	28996	179	325	141
268P	154	283118	138	28999	179	3251	140
269	202	283118	170	28999	179	3251K6	132
26900	203	2831T18	130	<b>29</b>		3251TR	140
26901	203	2831T901	130	2909	126	3251TRK6	132
26911	203	2831T902	130	2920	175	327	141
2691T11ESD	202	28352	172	2933	171	3271	140
26922	203	28360	180	2970	167	328	141
26937	203	283693	180	29701080S4	167	3281	140
26955	203	283695	180	29701200S4	167		

Artículo n°.	Página	Artículo n°.	Página	Artículo n°.	Página	Artículo n°.	Página
<b>33</b>		363TR	223	37390	271	<b>59</b>	
331	228	363TRH8	215	<b>38</b>		590T401	120
33391	268	363TRP7	191	380101	189	590T601	123
33394	267	363TRP8	191	380102	189	591T101	120
33397	266	363VB	214	380103	189	599001	122
334	225	364	228	380104	189	599006	122
334DSK6	216	364DS	224	380302020	189	599007	122
334DSR	224	364DSK6	216	380302021	189	5992	122
334DSR	224	364IP	228	38090101	189	5992	122
334N	227	364R	228	38090102	189	<b>70</b>	
334R	225	364VB	217	38090103	189	7000EB16ESD	201
334RVB	216	365	229	384	262	7000EB26ESD	201
334VB	216	365IP	229	386	262	7000SK65ESD	254
334Z	226	365IPVB	217	387	262	7000Z	255
336	226	365VB	217	387	262	7001	255
336N	227	366	222	387	263	7003Z	255
336Z	227	366BE	221	388	263	7003Z	255
33791	268	366BEH8	213	388DS	263	7005	255
338	226	366BEHZ13	212	<b>39</b>		7009	255
33891	269	366BET	222	397	151	7010Z	246
<b>34</b>		366BETSZ13TS	213	398	151	7011Z	246
341	149	366H8	214	<b>40</b>		7011Z	248
341K5	144	366R	221	40010	155	7012Z	246
343	149	366RH8	212	40010	155	7013RZ	247
344	150	366RHM7	212	40511	160	7013Z	247
347	150	366RHZ13	211	405A	160	7013ZH	247
347Z	150	366SZ13	214	405B	160	7015Z	246
<b>35</b>		366SZ13TS	213	<b>41</b>		7015ZH	246
350	221	366TS	222	4101000	333	7015ZK	246
350H7	211	367	148	4102000	333	7016Z	246
350H9	210	367R	148	4102001	333	7016ZIPR	246
351PG7	192	369	219	4102005	332	7017ZR	247
351PG9X	190	369B	220	4102007	333	7017ZR	247
351PK7	193	369E9F	206	4102008	332	7018Z	247
352B	220	369F	218	4111	332	7019ZOTTS	247
352H9B	210	369H11	209	4112	332	7019ZOTTW	247
352HM5B	211	369H7	209	4112	332	7019ZSIT	247
356	148	369H9	209	4113	332	7019ZSP	247
357	149	369H9B	210	<b>50</b>		7019ZXZN	247
3581	140	369HZ8	210	500	154	7040ZL	250
358N	141	369K	219	509	154	7041Z	250
<b>36</b>		369KH9	209	<b>53</b>		7042Z	250
361IP	222	369RE9F	206	530	151	7043Z	252
361IPH8	215	369RF	218	530HK6	145	7043ZR	252
362	148	369RF	218	530ZK6	145	7044M	258
362BE	147	369RH9	207	531	151	7044M	258
362ESD	158	369RHZ13	207	532	151	7044Z	256
362ESDK5	157	369RP7	192	<b>54</b>		7044Z	256
362IP	148	369RZ	218	540	225	7044Z	258
362K6SO	143	369S9	208	540DS	224	7045BE9570	254
362K7	143	369SZ13B	208	<b>55</b>		7045R	251
362R	147	369T	219	5527	156	7045Z	251
362RIP	148	369TS9	208	5533	156	7045Z	251
362RK6SO	143	369Z	219	5533HK5	156	7045ZH	252
362TR	148	369ZB	220	5533ZK5	156	7046Z	252
362TRK6	143	<b>37</b>		5534	156	7047ZR	252
363	223	370	229	5535	156	7048Z	252
363H8	214	370IP	229	5590N	108	7049PHM	250
363P7	190	370VB	217	5590NA	108	7049PZM	250
363P8	190	372	150	5590NT20	106	7049ZOTTS	252

# Registro de números de artículos

Artículo n°.	Página	Artículo n°.	Página	Artículo n°.	Página	Artículo n°.	Página
<b>71</b>		741592730030	188	9300019	112	SB2831B901	169
7103	256	741990102030	188	9300020	112	SB2831B902	137
7103	256	<b>78</b>		9300024	111	SB2831B902	169
7110	256	7802	199	9300025	102	SB2831B903	121
7110H	261	7803	199	9300026	111	SB2831B903	137
7113	261	7806	257	9300031	103	SB2831B903	169
7113P	261	7807	257	9300035	102	SB2831B904	121
7113S	261	<b>79</b>		9300040	100	SB2831B904	137
7123	260	79186B5	257	9300041	113	SB2831B950	136
7140	261	79187B5	257	93001001	115	SB2831B950	169
7143	261	79187T05	114	93001001	337	SB2831B951	136
7148	260	7928913	244	93001003	115	SB2831B951	169
7148CF	260	7928923	244	93001003	337	SB2831B992	139
7148CS	260	7928928	244	93001011	116	SB2831PB900	121
7183	261	7945H	240	93001011	336	SB2831PB900	137
<b>72</b>		7947005	242	93001013	116	SB2831PB901	121
7201	259	7947505	242	93001013	336	SB2831PB901	137
7201	259	7947505TR	242	93001911R	117	SB3201S204	132
7204Z	259	7947902	242	93001911R	337	SB327S2	133
7207NEX	109	7947904	242	930050005	104	SB328S2	133
7207NHS	110	7947905	242	930070103	97	SB351PM8X	190
7207NK2001	105	7947995	242	9300702	99	SB380201	187
7207NRW	108	7947999	242	<b>C0</b>		SB380304021	187
7207NS	109	7948005	241	C000A	340	SB4304010	155
7208NEX	109	7948043	241	C000A	340	SB43040K10	155
7208NHS	110	7948927	241	C000A100	339	SB534S5	330
7208NK2001	105	797901	245	C000A400	339	SB7945TY202	234
7208NS	109	797902	245	C000AVH	338	SB7945TY303	234
7209NEX	109	797903	245	C000C100	339	SB7945TY505	234
7209NEX	114	<b>80</b>		C000C400	339	SB7945TY903	234
7209NHS	110	800	328	C000CVH	338	SB7945TY904	234
7209NK2001	106	8001	328	C001A	342	SB7945TY905	234
7209NK2002	101	8001K	329	C001A	342	SB7946TY202	232
7209NK2003	107	800K	329	C001A200	339	SB7946TY303	232
7209NK2004	107	800S	329	C001C200	339	SB7946TY505	232
7209NRW	101	800V	328	C020	344	SB7946TY903	232
7209NS	109	802	328	C040	344	SB7946TY904	232
7210	258	8021	328	<b>C1</b>		SB7946TY905	232
7240	258	<b>82</b>		C101	345	SB7947005	243
<b>73</b>		829-0	327	C141	345	SB7947505	243
7311Z	256	<b>83</b>		C146	346	SB7947505TR	243
7312Z	256	830-0	327	C161	346	SB7947902	243
7321Z	256	831-1	326	<b>SB</b>		SB7947904	243
7322Z	256	831-3	326	SB24602	194	SB7947999	243
7325Z	256	831-5	326	SB28310101	134	SB7947T303	236
7331Z	256	831-8	327	SB28310301	134	SB7947T906	236
7332Z	257	831-9	327	SB28310401	134	SB7947T999	236
7341Z	257	832-13	325	SB2831B001	136	SB7947Y202	239
<b>74</b>		832-15	325	SB2831B001	168	SB7947Y505	239
741094060030	188	832-33	325	SB2831B501	136	SB7947Y904	239
741095565030	188	832-35	325	SB2831B501	168	SB7948T950	236
741190003030	188	832-38	325	SB2831B502	136	SB7948T999	236
741190102030	188	832-39	326	SB2831B502	168	SB7948Y505	238
741290003030	188	832-55	326	SB2831B601	136	SB7948Y904	238
741290102030	188	832-99	326	SB2831B601	168	SB7948Y950	238
741390304030	188	832B801	324	SB2831B801	136	<b>U</b>	
741390506030	188	<b>84</b>		SB2831B801	169	U106T12	196
741590608030	188	846	330	SB2831B900	137	U106T8	197
741591015030	188	<b>93</b>		SB2831B900	169	<b>XX</b>	
741592025030	188	9300018	103	SB2831B901	137	XX2872S3	166



Artículo nº.	Página
XX7011--922---	249
<b>Z</b>	
Z 01 0 01	295
Z 01 0 02	294
Z 01 0 05	294
Z 01 0 06	278
Z 01 0 09	278
Z 02 0 01	295
Z 02 0 02	295
Z 02 0 05	295
Z 02 0 06	278
Z 02 0 09	278
Z 02 2 02	279
Z 05 0 01	296
Z 05 0 02	296
Z 05 0 05	296
Z 05 0 06	279
Z 05 0 09	279
Z 05 1 01	297
Z 05 1 02	297
Z 05 1 05	296
Z 05 1 06	280
Z 05 1 09	280
Z 07 0 01	298
Z 07 0 02	298
Z 07 0 05	298
Z 07 0 06	280
Z 09 0 01	299
Z 09 0 02	299
Z 09 0 05	299
Z 09 0 06	280
Z 12 1 01	292
Z 12 1 02	292
Z 12 1 05	292
Z 12 1 06	276
Z 12 1 09	276
Z 14 0 06	276
Z 14 1 01	275
Z 14 1 06	275
Z 15 0 01	297
Z 16 2 01	293
Z 16 3 02	293
Z 16 3 05	292
Z 16 3 06	277
Z 16 3 09	277
Z 17 0 01	302
Z 18 0 01	291
Z 18 0 02	291
Z 18 0 05	291
Z 18 0 06	276
Z 21 0 01	300
Z 21 0 02	300
Z 21 0 05	300
Z 21 0 06	282
Z 22 0 01	301
Z 22 0 02	301
Z 22 0 06	282
Z 23 0 01	301
Z 23 0 05	301
Z 25 0 01	300

Artículo nº.	Página
Z 25 0 06	282
Z 26 0 00	306
Z 26 2 00	306
Z 27 0 01	307
Z 27 0 01K	307
Z 30 0 01	302
Z 31 0 00	302
Z 31 0 01	302
Z 32 0 01	303
Z 32 0 10	303
Z 33 0 01	305
Z 33 1 01	305
Z 33 4 01	304
Z 33 5 01	304
Z 34 0 01	305
Z 34 1 01	305
Z 34 4 01	304
Z 34 5 01	304
Z 36 0 01	297
Z 36 0 03	317
Z 36 0 04	312
Z 36 1 03	318
Z 36 1 04	312
Z 37 0 04	312
Z 38 0 04	312
Z 40 0 03	316
Z 40 1 03	317
Z 40 1 04	309
Z 40 3 04	309
Z 40 4 04	309
Z 41 1 03	316
Z 41 1 04	309
Z 41 3 03	316
Z 41 3 04	310
Z 41 4 04	310
Z 41 6 03	316
Z 43 1 04	310
Z 44 1 04	310
Z 44 3 01	298
Z 44 3 04	311
Z 46 0 03	317
Z 46 0 03	317
Z 46 1 04	311
Z 47 1 04	311
Z 47 2 04	311
Z 49 2 03	318
Z 49 2 03	318
Z 50 2 01	281
Z 50 3 06	281
Z 50 3 09	281
Z 55 0 01	283
Z 55 0 02	283
Z 55 0 05	283
Z 55 0 06	282
Z 55 0 09	282
Z 57 0 06	284
Z 57 5 06	284
Z 60 0 01	286
Z 60 0 06	286
Z 60 0 06	286

Artículo nº.	Página
Z 62 0 06	286
Z 62 0 06	287
Z 62 0 06	287
Z 62 0 06	287
Z 62 0 06	287
Z 62 0 06	288
Z 65 0 05	306
Z 65 2 05	306
Z 66 0 00	307
Z 71 5 06	288
Z 71 7 06	288
Z 72 0 06	284
Z 72 0 06	285
Z 73 0 06	285
Z 73 2 06	285
Z 74 0 06	285
Z57000106K	284
Z99000101	289
Z99000104	308
Z99000106	274
Z99000109	274
Z99000201	288
Z99000205	289
Z99000206	104
Z99000401	290
Z99000602	113
Z99000701	290
<b>ZP</b>	
ZP 01 0 14	313
ZP 06 0 14	313
ZP 07 1 14	313
ZP 09 0 14	313
ZP 11 0 14	313
ZP 15 0 14	313
ZP 16 0 14	314
ZP 18 0 14	314
ZP 20 1 14	314
ZP 20 2 14	314
ZP 24 0 14	314
ZP 25 2 14	314
ZP 46 0 14	315
ZP 50 0 14	315
ZP99014002	308

# Explicación de símbolos

## Tomas de fuerza

	Triángulo exterior
	Hexágono exterior
	Cuadrado exterior
	Hexágono interior
	Hexágono interior con taladro (Tamper Resistant)
	Hexágono interior con pivote
	Macho de roscar combi
	Pentalobe PL
	Phillips PH (ranura en cruz)
	Y-Type
	Pozidriv PZ (ranura en cruz)
	Robertson
	Punta redonda
	Ranurado
	Tuerca ranurada
	SIT
	Spanner
	Broca helicoidal
	manguito deslizante
	Torq-Set®
	TORX®
	TORX® con taladro (Tamper Resistant)
	TORX PLUS®
	Tri-Wing®
	Punta cuadrada
	Acoplamiento
	Cuadrado exterior
	Xeno SL/PZ

## Sistema de acoplamiento G7

	Empalme roscado
	Cuadrado interior
	SDS-Plus
	hexagonal
	SDS-Plus®
	Sechskant

## Destornillador [mm]

	Anchura del filo de corte
	Grosor de punta
	Diámetro de la varilla redonda
	Varilla hexagonal
	Cuello hexagonal
	Schaberbreite
	Abertura de la pinza
	Anchura de la pinza
	Anchura de la cabeza de la llave de vaso
	Longitud de la varilla
	Longitud del brazo
	Longitud del mango corregido dinamométrico
	Diámetro del mango
	máx. par de apriete [Nm]
	máx. par de apriete [in.lbs]
	Exactitud [%]
	Profundidad de la llave de cables
	Ancho del rascador
	Tiefe Kabelschlüssel

## Llave Allen [mm]

	Diámetro de la varilla redonda
	Varilla hexagonal
	Cuello hexagonal
	Longitud del brazo
	Longitud de la varilla
	Punta lateral del mango en T
	Ancho del mango
	Grosor

## Bits [mm]

	Empalme roscado
	Longitud de trabajo del taladro
	Tamaño de tornillo

## Alicates [mm]

	Boca plana
	Boca semiredonda
	Boca redonda
	Filo sin cortante
	Filo con cortante pequeño
	Filo con cortante
	Filo de yunque
	Filo cortante central
	Cortante de tijera
	Filo de corte frontal en los alicates pelacables
	máx. diámetro
	Área máxima de la sección
	Diámetro de tubo
	Ancho de llave
	Arandela de seguridad exterior
	Arandela de seguridad interior
	Límite de apriete
	Ancho de cabeza (plano)
	Fuerza de corte
	con resorte de apertura
	American Wire Gauge
	Longitud de la hoja de sierra

## Instrumentos de medición [mm]

	Eslabones anchos
	Color
	Capacidad de medición [mm]
	Capacidad de medición [pulgadas]

## Electro

	Batería
	Lúmenes de LED
	Luz láser

## Martillos de seguridad [mm]

	Diámetro del cabezal
	Anchura del cabezal
	Altura del cabezal

## Símbolos generales

	Peso, g
	Diámetro
	En blíster
	Longitud Total
	Longitud Total Pulgada
	Unidad de embalaje

TORX®, TORX PLUS® = marcas registradas de la empresa ACUMENT Global Technologies B.V.  
 ACR /AOT, Tri-Wing®, Torq-Set® = marcas registradas de la empresa Phillips Screw Company  
 Pozidriv = marca registrada de la empresa European Industrial Services Ltd.

## Destornilladores



Estabilidad de la caja de herramientas



Caja de herramientas con ruedas de transporte



Forma de la caja de herramientas



Caja de herramientas apta para transporte en avión

## Electro



Control de seguridad del par de apriete



Ahorra tiempo

## Destornilladores



MagicRing®



MagicSpring®



Cabeza esférica giratoria hasta 25°



slimTECHNOLOGY

## Par de apriete



Precisión: ±6%



Precisión: ±10%



slimTECHNOLOGY

## Llave Allen



MagicRing®



MagicSpring®



Cabeza esférica giratoria hasta 25°



Cabeza esférica Torx® giratoria hasta 25°



Visible con luz UV



95° Stubby

## Bits



Apto para destornillador Impact



Vida útil 120 veces larga



Visible con luz UV

## Alicates



Diámetro de corte a medida



Longitud de diámetro de pelado



Pelado automático



DynamicJoint®



Alicates de corte diagonal de fuerza



OptiGrip



MagicTips®



BiCut® Power



TriCut®

## Herramientas de percusión



Distribución óptima del peso



Extremo blando de la cabeza del martillo



Retirada de abrazaderas de clavos

## Dispositivo de medición



Completamente cerrado



Visión a partir de 10 °



Visible con luz UV

## General



Recomendado para electricistas, no aislado



Probado y homologado según VDE



Marca CE



Marca electrónica ESD

**Wiha Werkzeuge GmbH**  
**Obertalstraße 3-7**

78136 Schonach/Germany  
Phone +49 7722 959-0  
Fax +49 7722 959-159 Inland  
Fax +49 7722 959-155 Export  
info.de@wiha.com  
www.wiha.com

**Wiha Tools Ltd.**

841 Birchwood Boulevard  
Warrington  
WA3 7QU  
Phone +44 1527 57 57 58  
+44 1527 91 09 86  
Fax +44 1527 91 00 23  
info.uk@wiha.com  
www.wiha.com/en

**Wiha France SARL**

Z. A. de Terrefort  
33520 Bruges/France  
Phone +33 5 56 16 79 35  
Fax +33 5 56 16 79 36  
servicecommercial@wiha.fr  
www.wiha.com/fr

**Wiha Nordic A/S**

Korskildelund 6  
2670 Greve/Denmark  
Phone +45 70 23 80 45  
info.nordic@wiha.com  
www.wiha.com

**WIHA IBERIA / Willi Hahn S.A.**

Avda. Sant Julia, 1  
Edifici Tilma oficina 17  
08400 Granollers / Barcelona / Spain  
Iberia@wiha.com  
Tel. +34 916938 511  
www.wiha.com/es

**Wiha Polska Sp. z o.o.**

ul. Budowlanych 10 b  
80-298 Gdańsk/Poland  
Phone +48 58 762 38 30  
Fax +48 58 762 39 00  
info.pl@wiha.com  
www.wiha.com/pl

**Wiha in Russia**

Phone +48 58 762-38-30  
Fax +48 58 762-39-00  
michal.moczynski@wiha.com  
www.wiha.com

**Willi Hahn Corp.**

1348, Dundas Circle  
Monticello, MN 55362/USA  
Phone +1 763 2 95 65 91  
Fax +1 763 2 95 65 98  
cservice@wihatools.com  
www.wihatools.com

**Wiha Tools Canada Ltd.**

394 Deerhurst Drive  
L6T 5H9, Brampton, ON  
Phone +1 866 494 0096  
Fax +1 800 494 7456  
info@wihatools.ca  
www.wihatools.ca

**Wiha Asia Pacific Pte. Ltd.**

25 International Business Park  
#02 - 102 German Centre  
Singapore 609916  
Phone +65 6563 1277  
Fax +65 6563 7168  
info.sg@wiha.com  
www.wiha.com

**Wiha Tools (Shanghai) Co.Ltd.**

Tony Lv  
Room No. 908 - 910, Building 10,  
Long 2777, East Jinxiu Road,  
Pudong New District Shanghai,  
China 201206  
Phone +86 21 64401119  
Fax +86 21 64401112  
info.cn@wiha.com.cn  
www.wiha.com.cn

**Wiha Finland Oy**

Mäkituvantie 9  
FI-01510 Vantaa Finland  
Phone +358 44 231 9988  
raija.helin@wiha.com  
www.wiha.com

**Wiha en Belgique**

Phone +32 49 35 054 50  
info.belux@wiha.com  
www.wiha.com

**Wiha in Nederland**

Phone +31 64 63 113 30  
info.nl@wiha.com  
www.wiha.com/nl

**Wiha in Italia**

Thoelke Rappresentanze Srl  
Phone +39-0332-966039  
info.it@wiha.com  
www.wiha.com/it

**Premium Tools Australia Pty Ltd.**

Unit 11, 8-20 Anderson Rd,  
Smeaton Grange 2567, NSW  
Australia  
Phone +61 02 4684 1460  
Fax +61 02 8088 7272  
sales@wiha.com.au  
www.wiha.com.au

**Premium Tools (NZ) Ltd.**

Unit 1D, 89 Ellice Rd,  
Wairau Valley, 0629, Auckland  
New Zealand  
Phone +64 09 444 2560  
Fax +64 09 355 0411  
sales@wiha.co.nz  
www.wiha.co.nz